



**LIST OF NEW MODELS
SINCE VOL. 17**

LIST OF NEW MODELS SINCE VOL. 17

| TEIKIN NO | ENGINE MODEL | | BORE Ø (mm) | PAGE | BOX NO. |
|-----------|--------------|-----------------|-------------|------|---------|
| 30114 | CHEVROLET | SPIN 1.5 | 74.71 | 8 | 3 |
| 30113 | CHEVROLET | CAPTIVA 3.2 | 89.00 | 10 | 10 |
| 31130-6 | CHRYSLER | POWER TECH 3.7 | 93.00 | 12 | 6 |
| 31130 | CHRYSLER | POWER TECH 4.7 | 93.00 | 12 | 7 |
| 31131 | CHRYSLER | HEMI 5.7 | 99.50 | 13 | 12 |
| 32151 | DAIHATSU | EJ-VE-II | 72.00 | 18 | 7 |
| 34130 | FIAT | SHAHEN | 80.50 | 27 | 16 |
| 34131 | FIAT | TEMPRA 1600 TWO | 86.40 | 28 | 17 |
| 35191 | FORD | CVH 2.0 | 84.86 | 32 | 10 |
| 36661A | HINO | W06DT | 104.00 | 40 | 7 |
| 37116 | HOLDEN | 202 | 92.08 | 47 | 1 |
| 38666 | HONDA | D13 | 75.00 | 51 | 13 |
| 38667 | HONDA | D15-II | 75.00 | 52 | 17 |
| 38668 | HONDA | B18A1 | 81.00 | 56 | 35 |
| 38199 | HONDA | K20A5 | 86.00 | 61 | 53 |
| 38197 | HONDA | ACCORD | 87.00 | 61 | 56 |
| 38198 | HONDA | K24A | 87.00 | 62 | 60 |
| 51145 | HYUNDAI | G4FC-II | 77.00 | 71 | 15 |
| 51144 | HYUNDAI | G4KD | 86.00 | 74 | 27 |
| 51606AG | HYUNDAI | D4BH | 91.10 | 78 | 44 |
| 51607A | HYUNDAI | D4AF-III | 104.00 | 79 | 47 |
| 39675AG | ISUZU | 4JK1-TC | 95.40 | 95 | 60 |
| 39137-4 | ISUZU | DA220 | 100.00 | 96 | 63 |
| 39672A | ISUZU | 4HF1 NEW | 112.00 | 103 | 92 |
| 39676AG | ISUZU | 4HG1-T | 115.00 | 104 | 95 |
| 39677AG | ISUZU | 6HL1-TC | 115.00 | 105 | 100 |
| 64602A | KOMATSU | 4D105 | 105.00 | 114 | 2 |
| G0123 | KUBOTA | RD 55 | 76.00 | 325 | 4 |
| G0124 | KUBOTA | RD 85S | 88.00 | 328 | 15 |

LIST OF NEW MODELS SINCE VOL. 17

| TEIKIN NO | ENGINE MODEL | | BORE Ø (mm) | PAGE | BOX NO. |
|-----------|--------------|-----------------|-------------|------|---------|
| 59109 | LADA | VAZ 2105 | 79.00 | 115 | 3 |
| 42678 | MAZDA | F2T | 86.00 | 131 | 47 |
| 42223 | MAZDA | SKYACTIV-G 2.5L | 89.00 | 135 | 61 |
| 43696-3 | MITSUBISHI | 3A91 | 75.00 | 151 | 12 |
| 43296 | MITSUBISHI | 3A92 | 75.00 | 152 | 13 |
| 43696 | MITSUBISHI | 4A91 | 75.00 | 152 | 14 |
| 43692 | MITSUBISHI | 4B11 | 86.00 | 160 | 48 |
| 43297 | MITSUBISHI | 6B31 | 87.60 | 162 | 56 |
| 43694 | MITSUBISHI | 4B12 | 88.00 | 163 | 57 |
| 43693A | MITSUBISHI | 4D34T-II | 104.00 | 178 | 117 |
| 43691AG | MITSUBISHI | 4D35 / 4D35T | 110.00 | 179 | 122 |
| 43695AG | MITSUBISHI | 6M61 | 118.00 | 184 | 143 |
| 44355 | NISSAN | E15-III | 76.00 | 192 | 21 |
| 44699 | NISSAN | H25 | 92.00 | 210 | 95 |
| 44702AG | NISSAN | ZD30DD | 96.00 | 222 | 140 |
| 44698A | NISSAN | FD33 | 100.00 | 223 | 146 |
| 67101 | PEUGEOT | 2031 70 | 75.00 | 238 | 1 |
| 67102 | PEUGEOT | 2297 50 | 83.00 | 238 | 2 |
| 67103 | PEUGEOT | 2300 90 | 88.00 | 238 | 3 |
| 55109 | SUBARU | EJ255-III | 99.50 | 243 | 13 |
| 45151 | SUZUKI | K6A | 68.00 | 245 | 5 |
| 45148 | SUZUKI | K14B | 73.00 | 246 | 12 |
| 45149 | SUZUKI | G15A | 75.00 | 249 | 23 |
| 45657 | SUZUKI | M15A-II | 78.00 | 251 | 32 |
| 45147 | SUZUKI | SX4 | 84.00 | 252 | 36 |
| 45150 | SUZUKI | J20A-II | 84.00 | 252 | 35 |
| 62103A | TATA | 207 | 83.00 | 255 | 4 |
| 68101A | TEMPO | TRAVELLER | 90.90 | 257 | 1 |
| 46387 | TOYOTA | 3NR-FE | 72.50 | 259 | 9 |
| 46688 | TOYOTA | 3ZR-FE-II | 80.50 | 267 | 44 |
| 46689 | TOYOTA | 3SGE-II | 86.00 | 279 | 92 |

LIST OF NEW MODELS SINCE VOL. 17

| TEIKIN NO | ENGINE MODEL | | BORE Ø (mm) | PAGE | BOX NO. |
|-----------|--------------|-------------|-------------|------|---------|
| 46697 | TOYOTA | 1AR-FE | 90.00 | 285 | 114 |
| 46388 | TOYOTA | 3UR-FE | 94.00 | 288 | 128 |
| 46694 | TOYOTA | 3RZ-F | 95.00 | 290 | 136 |
| 46690AG | TOYOTA | 1CD-FTV-II | 82.20 | 292 | 144 |
| 46692 | TOYOTA | 1C NEW | 83.00 | 293 | 146 |
| 46696AG | TOYOTA | 2AD-FTV | 86.00 | 295 | 153 |
| 46695AG | TOYOTA | 2CT-III | 86.00 | 296 | 160 |
| 46698AG | TOYOTA | 1KD-FTV-III | 96.00 | 305 | 193 |
| G1603 | YANMAR | TS 50-II | 70.00 | 333 | 2 |
| G1604 | YANMAR | TS 60-II | 75.00 | 334 | 5 |
| G1605 | YANMAR | TS 70-II | 79.90 | 334 | 8 |
| G1601 | YANMAR | TS 105-II | 85.00 | 336 | 14 |
| G1602 | YANMAR | TS 180-II | 102.00 | 338 | 22 |

TEIKIN[®]

ENGINE COMPONENTS

PRODUCT
CATALOG
Vol. **18**



PISTONS • KOLBEN • PISTONES • بستونات

CYLINDER LINERS • ZYLINDERBUCHSEN • CAMISAS DE CILINDRO • قمصان

LINER KIT SETS • ASSEMBLY • CONJUNTOS • طقم قمصان مع بستونات



 **TEIKIN**[®]
ENGINE COMPONENTS
CATALOG
VOL. 18

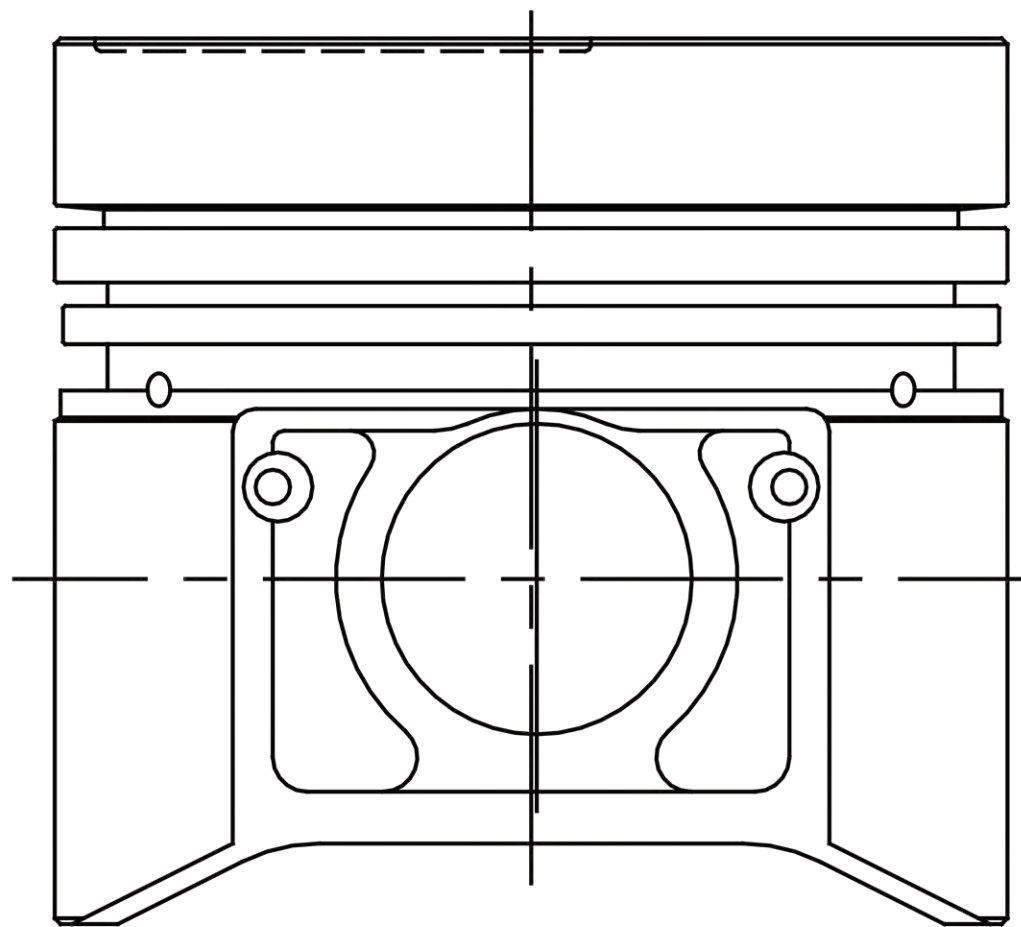

ALL RIGHTS RESERVED. NO PART OF THIS CATALOG MAY BE REPRODUCED BY ANY MEANS - MECHANICAL, ELECTRONIC, OR GRAPHIC, INCLUDING PHOTOCOPYING, RECORDING, SCANNING OR INFORMATION STORAGE AND RETRIEVAL SYSTEM - WITHOUT OUR SPECIFIC WRITTEN PERMISSION.

WE SPECIFICALLY DISCLAIM ANY AND ALL LIABILITIES ARISING FROM ERRORS, OMISSIONS, AND HARM RESULTING FROM THE INFORMATION GIVEN IN THIS CATALOG. THE SAID INFORMATION PROVIDED ARE ALSO SUBJECT TO CHANGE AT OUR DISCRETION WITHOUT PRIOR NOTICE.

REFERENCES, FIGURES AND DESCRIPTIONS MADE TO AUTOMOTIVE, ENGINE AND OTHER MANUFACTURERS' PART NUMBERS AND TRADE NAMES IN THIS CATALOG ARE FOR THE PURPOSE OF EXPLANATION AND CROSS REFERENCING ONLY AND DO NOT IMPLY THAT THESE PARTS ARE MANUFACTURED BY OR FOR THE TRADE NAMES' OWNERS.

MAIN PISTON FACTORY



TEIKIN® Pistons VS Other Brands

Comparison of Material Used Piston for Mazda 5S-K2700 (Teikin No. 42198)

| Element | Specification* (%) | Teikin (%) | Other Maker #1 (%) |
|--------------|--------------------|------------|--------------------|
| Cu Cooper | 0.8 - 1.3 | 1.0612 | 1.7331 |
| Si Silicon | 11.0 - 13.0 | 12.137 | 9.7297 |
| Mg Magnesium | 0.8 - 1.3 | 1.0833 | 0.83999 |
| Zn Zinc | 0.15 max | 0.05027 | 0.28011 |
| Fe Iron | 0.7 max | 0.45063 | 0.65748 |
| Mn Manganese | 0.15 max | 0.05827 | 0.22084 |
| Ni Nickel | 0.8 - 1.5 | 1.3726 | 0.66118 |
| Ti Titanium | 0.20 max | 0.09490 | 0.07853 |
| Cr Chromium | 0.10 max | 0.02110 | 0.03685 |
| Sn Tin | 0.05 max | 0.02013 | 0.02378 |
| Pb Lead | 0.05 max | 0.021268 | 0.05692 |

*Specification based upon Japanese Industrial Standard Number D3104-1996

Comparison of Roundness Profile Piston for Toyota 2Y (Teikin No. 46119)

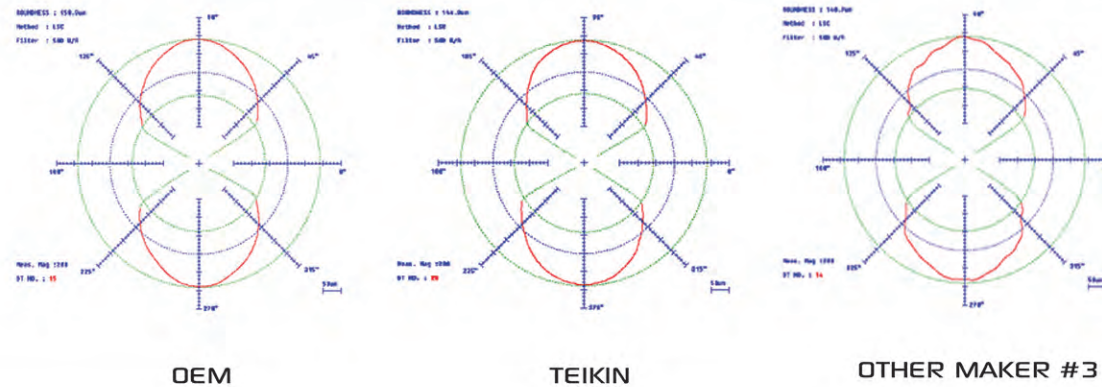

Comparison of Crown Flatness Piston for Mitsubishi 4D68T (Teikin No. 43612)

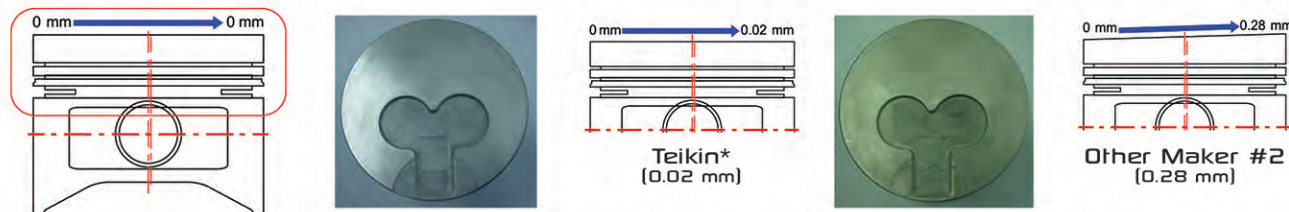

*Allowable flatness is 0.05 mm max - as per Design Manual of Edico Utama, P.T.

Comparison of Ring Grooves Perpendicularity Piston for Suzuki F8A (Teikin No. 45652)

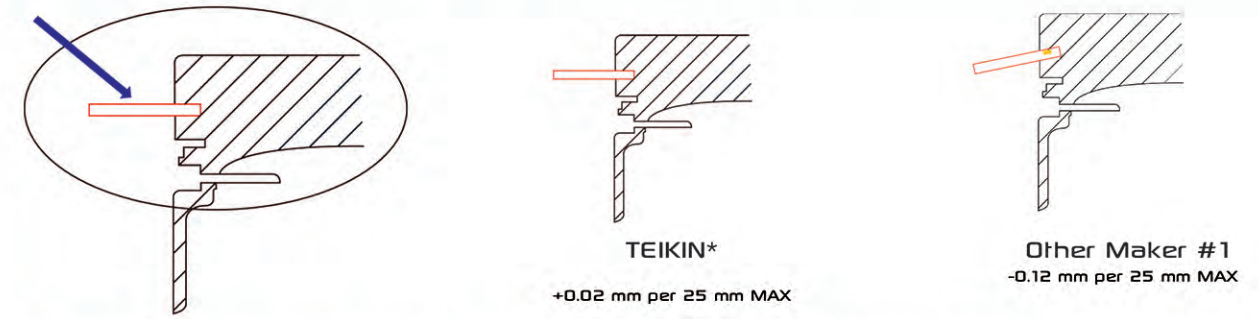

*Allowable perpendicularity is 0.04 mm per 25 mm as per Japanese Industrial Standard D 3104-1996

Comparison of Pin Hole Perpendicularity Piston for Suzuki G I 3-II (Teikin No. 45650)

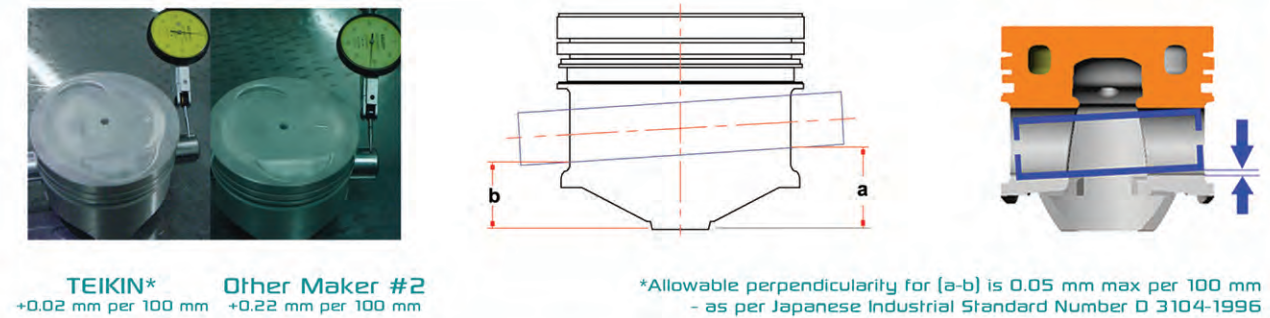

WHY TEIKIN® PISTONS ARE THE BEST FOR YOUR ENGINES?

- Outstanding Quality Material as per OEM Specifications
- 100% Brand New Primary Virgin Aluminum Ingot
- Minimal Presence of Metal Impurities in Material to Maximize Performance
- Hard Metals of Nickel and Silicon to Maximize Piston Hardness and Limit Piston Expansion
- Eutectic and Hyper Eutectic Aluminum Alloy
- Precise Heat Treatment & Stress Relief Procedure for Maximum Material Strength
- Guaranteed to Meet or Exceed OEM Specifications
- Guaranteed Ring Grooves Perpendicularity
- Guaranteed Pin Hole Perpendicularity
- Guaranteed Outer Diameter Roundness Profile
- Guaranteed Crown Flatness
- Non - Magnetic Alfin Inserts Reinforcement
- Cooling Gallery Channel
- Electroplated Expansion Control Strut
- OEM Quality Surface Treatments
 - Tin Coating
 - Anodized Crown
 - Moly Skirt

PISTON WITH COOLING GALLERY

COOLING GALLERY



PISTON WITH COOLING GALLERY

ARE CREATED FOR OPERATION IN HIGH TEMPERATURE ENVIRONMENT SUCH AS IN TURBO ENGINES. THROUGH OIL CIRCULATION IN THE GALLERY, PISTONS ARE INTENSIVELY COOLED IN THE PISTON CROWN AND RING BELT AREA.

SUCH COOLING EFFECT ALSO RESULT IN SMALLER EXPANSION THUS ALLOWING FOR SMALLER BORE-TO-PISTON CLEARANCE RESULTING IN SMOOTHER AND MORE FUEL EFFICIENT ENGINES. THESE TYPE OF PISTONS ALLOW ENGINE DESIGNERS TO CREATE MORE POWERFUL YET FRIENDLY TO THE ENVIRONMENT.

PISTON WITH ALFIN REINFORCEMENT

ALFIN REINFORCEMENT



PISTON WITH ALFIN REINFORCEMENT ARE RESISTANT TO COMPRESSION RING GROOVE WEAR. THE ALFIN REINFORCEMENT ALSO ACT AS A HEAT BARRIER MINIMIZING HEAT CONDUCTION FROM PISTON SKIRT AREA. SUCH PISTONS CAN THUS WITHSTAND THE DEMAND FOR HIGHER LOAD AND HIGHER PERFORMANCE ENGINE.



ANODIZED CROWN & MOLYBDENUM-COATED SKIRT

ANODIZATION OF PISTON CROWN CREATES A HARD CROWN SURFACE THUS PROVIDING PISTONS WITH EXTRA PROTECTION AGAINST CROWN PITING AND WEAR.

THE MOLYBDENUM COATED SKIRT PRODUCES LESS FRICTIONAL HEAT AND ENGINE NOISE. THE EXTRA LUBRICATIVE EFFECT ALSO MINIMIZE CYLINDER BORE WEAR AND PREVENT PISTON SCUFFING.

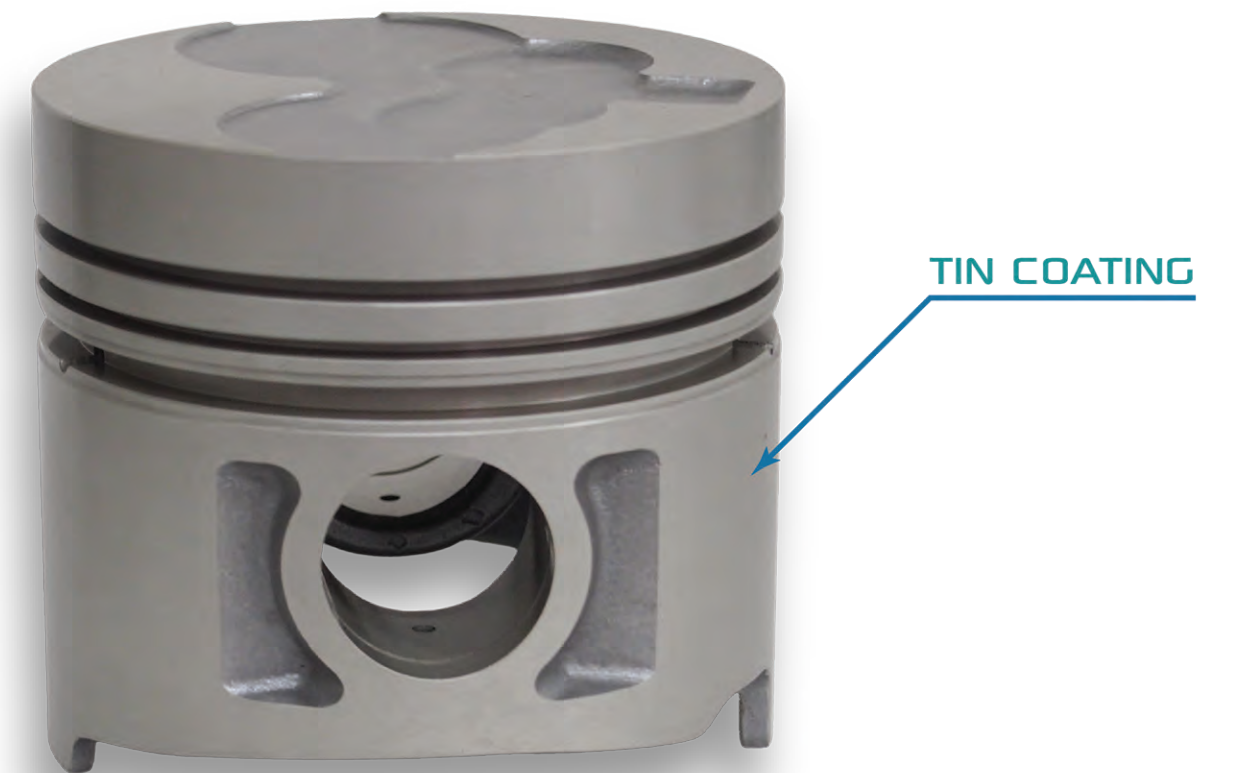

PISTON WITH TIN-COATED SURFACE

TIN COATED SURFACE PROVIDES EXTRA LUBRICATION AND SMOOTHER RUNNING OF CYLINDER COMPONENTS RESULTING IN LONGER ENGINE LIFETIME.



PISTON TERMINOLOGY

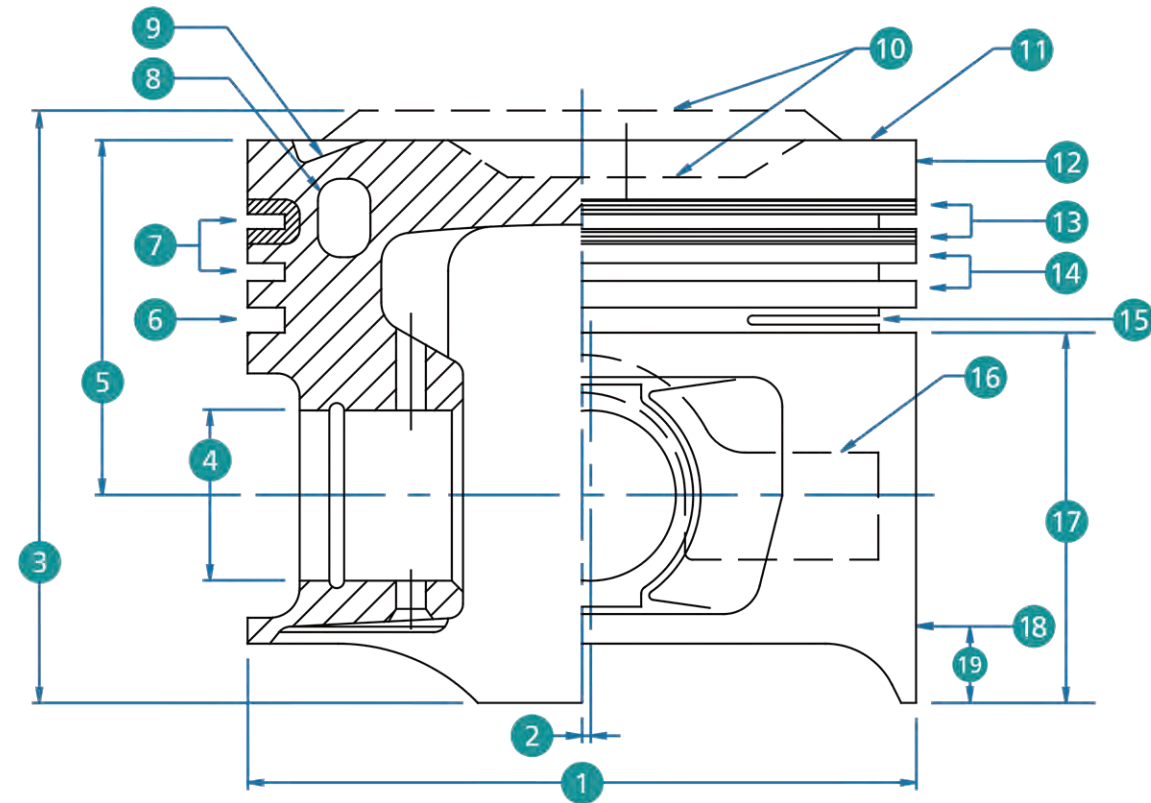

- 01. PISTON SKIRT DIAMETER
- 02. ECCENTRICITY OF PIN AXIS AGAINST PISTON AXIS
- 03. TOTAL PISTON LENGTH
- 04. GUDGEON PIN HOLE DIAMETER
- 05. COMPRESSION HEIGHT
- 06. OIL RING GROOVE
- 07. FIRST AND SECOND COMPRESSION RING GROOVES
- 08. OIL COOLING GALLERY
- 09. VALVE POCKET

- 10. DEPRESSED COMBUSTION CHAMBER OR RAISED CROWN
- 11. PISTON CROWN
- 12. CROWN LAND
- 13. ALFIN REINFORCEMENT
- 14. RING LAND
- 15. OIL SLIT GROOVE
- 16. HIDDEN STEEL STRUTS
- 17. SKIRT AREA
- 18. POINT OF MRC MEASUREMENT (Minimum Recommended Clearance)
- 19. HEIGHT OF MP (Measuring Point)

CYLINDER LINER TERMINOLOGY

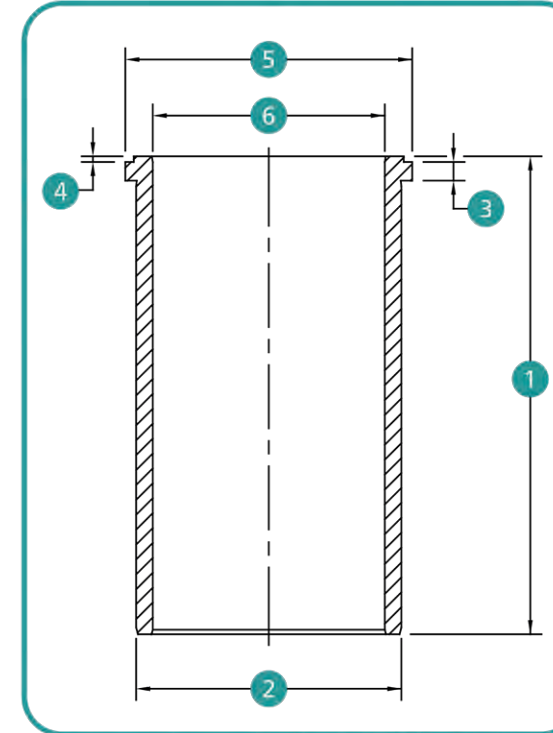

DRY TYPE WITH FLANGE

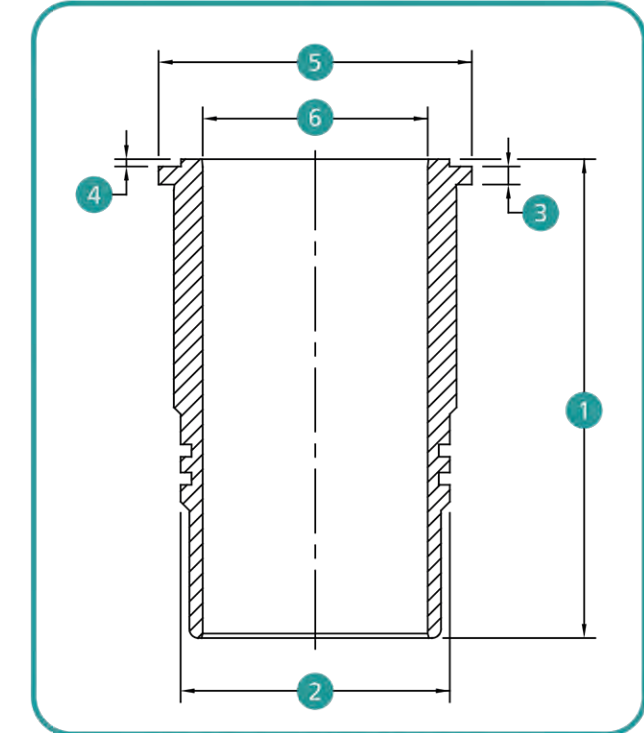

WET TYPE WITH FLANGE

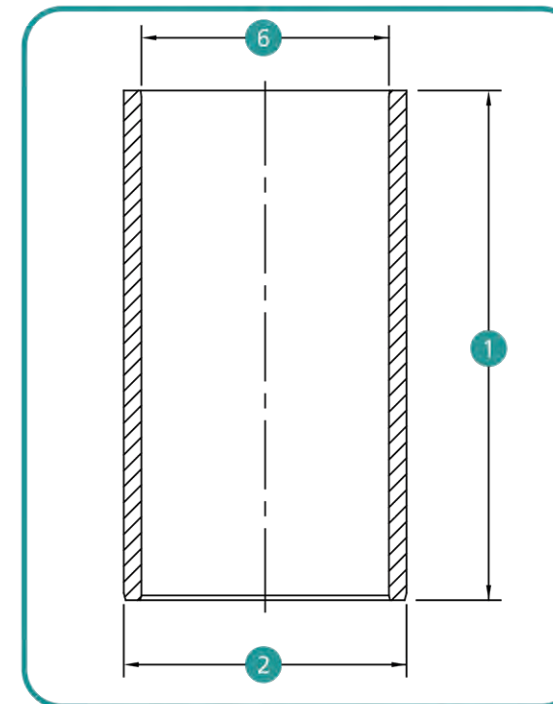

DRY TYPE WITHOUT FLANGE

- 1 TOTAL LENGTH (TL)
- 2 OUTER DIAMETER (OD)
- 3 FLANGE THICKNESS (FT)
- 4 FIRE LIP HEIGHT (+)
- 5 FLANGE DIAMETER (FD)
- 6 INNER DIAMETER
- FULLY FINISHED TYPE (FF)
- SEMI FINISHED TYPE (SF)

- LSX - Liners are Semi-Finished & Without Flange
- LSF - Liners are Semi-Finished & With Flange
- LFX - Liners are Fully-Finished & Without Flange
- LFF - Liners are Fully-Finished & With Flange
- LCX - Liners are Chromed & Without Flange
- LCF - Liners are Chromed & With Flange

TEIKIN® ENGINE COMPONENTS ARE MANUFACTURED UNDER THE HIGHEST PRECISION STANDARD AND STRICT QUALITY SYSTEM. AS SUCH, TEIKIN® ENGINE COMPONENTS MUST BE HANDLED WITH THE UTMOST OF CARE DURING INSTALLATION.

GENUINE TEIKIN® PISTONS FOR THE AFTERMARKET ARE SUPPLIED COMPLETE WITH GUDGEON PINS AND CIRCLIPS. WE RECOMMEND FULL AND COMPLETE ENGINE SET REPLACEMENT OF PISTONS, PINS AND CIRCLIPS FOR ALL CYLINDERS.

TEIKIN® PISTONS IN A BOX SET ARE GRADED ACCORDING TO THE APPROPRIATE FIT. HENCE WE RECOMMEND USING THE FULL SET IN THE BOX.

PISTON CROWNS ARE MARKED WITH THE APPROPRIATE SIZE AND INSTALLATION DIRECTION. SUCH MARKINGS ARE TO BE OBSERVED AND FOLLOWED ACCORDINGLY.

MINIMUM RECOMMENDED CLEARANCE (MRC) VALUE BETWEEN PISTON SKIRT & CYLINDER LINER/BORE WALL AND PISTON SKIRT DIAMETER MEASURING POINT (MP) LOCATION FOR EACH ENGINE IS PROVIDED IN THIS CATALOG.

INSTALLATION OF POWER-UP / TURBO CHARGER / TURBO CONVERSION KIT ONTO AN ORIGINALLY NON-TURBO ENGINE IS NOT RECOMMENDED.

PISTON RINGS MUST BE ASSEMBLED AND FITTED CORRECTLY ONTO THE PISTON. EXCESSIVE FORCE DURING THEIR REMOVAL AND FITTING WILL CAUSE PERMANENT DEFORMATION TO THE RINGS AND IMPAIR THEIR SEALING PERFORMANCE. THE RING GAPS MUST BE DISTRIBUTED EVENLY AROUND THE CIRCUMFERENCE OF THE PISTON.

CIRCLIPS MUST BE FITTED WITH THEIR GAPS FACING TOWARD THE BOTTOM SIDE OF THE GUDGEON PIN HOLES.

CYLINDER LINERS / BORES MUST BE CLEANED AND INSPECTED FOR DAMAGES AND CORROSION. CORRODED AND DAMAGED SURFACES MUST BE REMOVED BY REBORING AND INSTALLING OVERSIZED LINERS IF NECESSARY.

LINER FLANGES' SEATS IN THE BORE MUST BE CLEANED, PROPERLY CHAMFERED AND PERPENDICULAR TO THE BORE AXIS. INCORRECT SEATS WILL CAUSE BREAKAGE TO FLANGES AND CAUSE MAJOR DAMAGE TO THE ENGINE.

CONNECTING RODS MUST BE CHECKED FOR PARALLELISM & DISTORTION AND RE-ALIGNED AS NECESSARY.

ALL COMPONENTS IN THE ENGINE MUST BE THOROUGHLY LUBRICATED AND CLEANED FROM DIRT, MACHINING RESIDUES AND FOREIGN MATTERS BEFORE ENGINE ASSEMBLY.

CYLINDER HEAD BOLTS ARE TO BE TIGHTENED TO THE TORQUE AND ROTATION ANGLE SPECIFIED BY THE ENGINE MAKER.

IN DIESEL ENGINES, INJECTION PUMP TIMING AND SETTING MUST BE SET AS PER THE FACTORY STANDARD.

USE OF AEROSOL STARTING AID IS TO BE AVOIDED.

ENGINE COOLING AND LUBRICATION SYSTEM MUST BE CAREFULLY CHECKED BEFORE IGNITING THE ENGINE.

AUTOMOTIVE ENGINES

| | | | |
|-----|----------------|-----|---------------|
| 001 | ACURA | 109 | KIA |
| 002 | ASHOK LEYLAND | 114 | KOMATSU |
| 003 | ASIA | 115 | LADA |
| 004 | AUDI | 117 | LAND ROVER |
| 005 | BEDFORD | 118 | LEYLAND |
| 006 | BMW | 119 | MAHINDRA |
| 007 | CHERRY | 120 | MAZDA |
| 008 | CHEVROLET | 145 | MERCEDES BENZ |
| 011 | CHRYSLER | 149 | MITSUBISHI |
| 015 | DAEWOO | 187 | NISSAN |
| 017 | DAIHATSU | 231 | OPEL |
| 023 | EICHER | 237 | PERKINS |
| 024 | FIAT | 238 | PEUGEOT |
| 030 | FORD | 239 | PROTON |
| 036 | GENERAL MOTORS | 240 | SUBARU |
| 039 | HINO | 244 | SUZUKI |
| 047 | HOLDEN | 255 | TATA |
| 048 | HONDA | 257 | TEMPO |
| 068 | HYUNDAI | 258 | TOYOTA |
| 080 | ISUZU | 312 | VOLGA |
| 108 | JEEP WILLYS | 313 | VOLKSWAGEN |





STATIONARY, AGRICULTURAL, MARINE & OTHER ENGINES

| | |
|-----|----------------------------------|
| 323 | AIR BRAKE COMPRESSORS |
| 326 | KUBOTA |
| 332 | MITSUBISHI |
| 334 | YANMAR |
| 341 | JOHNSON MARINE |
| 345 | MERCURY MARINE |
| 350 | YAMAHA MARINE |
| 353 | OTHER NON-AUTOMOTIVE ENGINES |
| 355 | LIST OF NEW MODELS SINCE VOL. 17 |
| 359 | NUMERICAL INDEX |
| 395 | PISTON PIN LIST |
| 408 | PISTON RING LIST |
| 422 | PISTON LINER LIST |

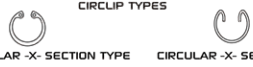
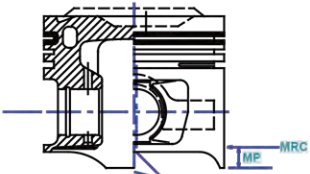
CATALOG NOMENCLATURE

| ENGINE TYPE | PISTON | PISTON RING | PISTON PIN | PIN BUSHING | LINER | | LINER KIT SET |
|-------------------|----------------|---------------|--------------|---------------|----------------------|-----------|---------------|
| | | | | | FLANGED | NO FLANGE | |
| 1 | ∅ CD TL | 5 | ∅ TL 6 | | TL OD FT FD | 7 | TEIKIN NO. |
| | TEIKIN NO. | TEIKIN NO. | TEIKIN NO. | TEIKIN NO. | TEIKIN NO. | | 11 |
| | 3 | | | | 10 | | |
| | REFERENCE NO. | REFERENCE NO. | | REFERENCE NO. | REFERENCE NO. | | |
| Surface Treatment | Bore Clearance | | | | | | |
| 8 | 9 | 4 | | | | | |

| | | |
|--|--|---|
| <p>1</p> <ul style="list-style-type: none"> APPLICATION AND / OR ENGINE MODELS WITH YEARS OF APPLICATION. CAPACITY OF ENGINE IN CUBIC CENTIMETERS (CC). NUMBER OF CYLINDERS. | <p>6</p> <ul style="list-style-type: none"> NOMINAL OUTER DIAMETER OF PISTON PINS. TL - TOTAL LENGTH OF PISTON PIN <p>CIRCUIT TYPES</p>  <p>RECTANGULAR -X- SECTION TYPE CIRCULAR -X- SECTION TYPE</p> | <p>10</p> <ul style="list-style-type: none"> TEIKIN LINER NUMBERING SYSTEM. <ul style="list-style-type: none"> PREFIX "LSX" MEANS LINERS ARE SEMI-FINISHED AND NO FLANGE. PREFIX "LSF" MEANS LINERS ARE SEMI-FINISHED AND FLANGED. PREFIX "LFX" MEANS LINERS ARE FULLY FINISHED AND NO FLANGE. PREFIX "LFF" MEANS LINERS ARE FULLY FINISHED AND FLANGED. PREFIX "LCX" MEANS LINERS ARE CHROMED AND NO FLANGE. PREFIX "LCF" MEANS LINERS ARE CHROMED AND FLANGED. |
| <p>2</p> <ul style="list-style-type: none"> NOMINAL BORE DIAMETER. CD - COMPRESSION DISTANCE OF PISTON IN MILLIMETERS. TL - TOTAL LENGTH OF PISTON IN MILLIMETERS. | <p>7</p> <ul style="list-style-type: none"> TL - TOTAL LENGTH OF CYLINDER LINER IN MILLIMETERS. OD - OUTER DIAMETER OF CYLINDER LINER IN MILLIMETERS. FT - FLANGE THICKNESS OF CYLINDER LINER IN MILLIMETERS. FD - FLANGE DIAMETER OF CYLINDER LINER IN MILLIMETERS. | <p>11</p> <ul style="list-style-type: none"> TEIKIN LINERKIT NUMBERING SYSTEM. <ul style="list-style-type: none"> PREFIX "LKSX" MEANS LINERKIT WITH SEMI-FINISHED AND NO FLANGE LINERS. PREFIX "LKSF" MEANS LINERKIT WITH SEMI-FINISHED AND FLANGED LINERS. PREFIX "LKFX" MEANS LINERKIT WITH FULLY FINISHED AND NO FLANGE LINERS. PREFIX "LKFF" MEANS LINERKIT WITH FULLY FINISHED AND FLANGED LINERS. PREFIX "LKCX" MEANS LINERKIT WITH CHROMED AND WITH NO FLANGE LINERS. PREFIX "LKCF" MEANS LINERKIT WITH CHROMED AND FLANGED LINERS. |
| <p>3</p> <ul style="list-style-type: none"> TEIKIN NUMBER FOR PISTON. <ul style="list-style-type: none"> SUFFIX "A" REFERS TO PISTONS WITH ALFIN REINFORCEMENT. SUFFIX "G" REFERS TO PISTONS WITH OIL COOLING TUNNEL (GALLERY) SUFFIX "AG" REFERS TO PISTONS WITH BOTH ALFIN AND GALLERY. (SUPERSEDED NUMBERS ARE GIVEN IN PARENTHESIS.) | <p>8</p> <ul style="list-style-type: none"> TYPE OF SURFACE TREATMENT. TIN COATED • MOLY SKIRT • ANODIZED CROWN. | |
| <p>4</p> <ul style="list-style-type: none"> REFERENCE NO. THESE NUMBERS REFER TO COMMONLY USED NUMBERS IN THE SPAREPARTS INDUSTRY. | <p>9</p>  <ul style="list-style-type: none"> BORE CLEARANCE. MRC - MINIMUM RECOMMENDED CLEARANCE. MEASURED AT THIS MEASURING POINT. MP - MEASURING POINT HEIGHT MEASURED FROM SKIRT BOTTOM. | |
| <p>5</p> <ul style="list-style-type: none"> PISTON RING SIZES. <ul style="list-style-type: none"> SUFFIX "FK" REFERS TO FULL KEYSTONE TYPE RINGS. SUFFIX "HK" REFERS TO HALF KEYSTONE TYPE RINGS. | | |

| ENGINE TYPE | PISTON | PISTON RING | PISTON PIN | PIN BUSHING | LINER | | LINER KIT SET |
|--|--|------------------------|---|-------------|---------|-----------|---------------|
| | | | | | FLANGED | NO FLANGE | |
| CLAYTON DEWANDRE 6CF, 9CF, SC6 COMPRESSORS 1 cyl. | \emptyset 66.68 CD 22.0 TL 44.3 | 3 - 4.0 | \emptyset 11.107 TL 56.98  | | | | TEIKIN NO. |
| | TEIKIN NO. | | TEIKIN NO. | | | | |
| | G9111 | | P G9111 | | | | |
| | REFERENCE NO. | | | | | | |
| Surface Treatment Bore Clearance None MRC: 0.080 mm MP: 3.20 mm | | | | | | | 1 |
| MC2 TUFLO 501 MC 2 2 cyl. | \emptyset 66.68 CD 27.0 TL 59.5 | 3 - 2.4 2 - 3.2 | \emptyset 13.495 TL 59.48  | | | | TEIKIN NO. |
| | TEIKIN NO. | | TEIKIN NO. | | | | |
| | G9106 | | P G9106 | | | | |
| | REFERENCE NO. | | | | | | |
| Surface Treatment Bore Clearance None MRC: 0.066 mm MP: - mm | | | | | | | 2 |
| MC3 EL-1300, EL-1600 MC 3 2 cyl. | \emptyset 69.85 CD 26.2 TL 50.3 | 3 - 4.8 | \emptyset 14.275 TL 60.73  | | | | TEIKIN NO. |
| | TEIKIN NO. | | TEIKIN NO. | | | | |
| | G9107 | | P G9107 | | | | |
| | REFERENCE NO. | | | | | | |
| Surface Treatment Bore Clearance None MRC: 0.142 mm MP: 3.00 mm | | | | | | | 3 |
| MC5 MC M706113 MC 5 2 cyl. | \emptyset 70.50 CD 31.8 TL 55.3 | 3 - 2.4 2 - 4.8 | \emptyset 13.495 TL 62.99  | | | | TEIKIN NO. |
| | TEIKIN NO. | | TEIKIN NO. | | | | |
| | G9109 | | P G9109 | | | | |
| | REFERENCE NO. | | | | | | |
| Surface Treatment Bore Clearance None MRC: 0.056 mm MP: - mm | | | | | | | 4 |







SUITABLE FOR

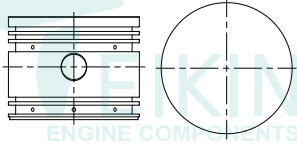

AIR BRAKE

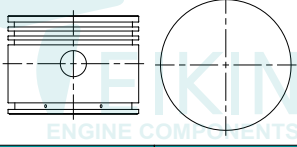
COMPRESSORS

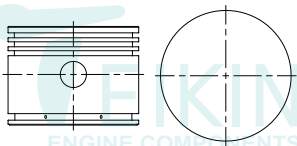

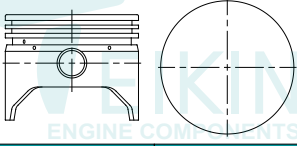
A

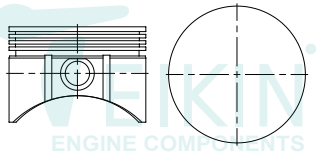
| ENGINE TYPE | PISTON | PISTON RING | PISTON PIN | PIN BUSHING | LINER | | LINER KIT SET |
|---|--|--------------------|---|-------------|---------|-----------|---------------|
| | | | | | FLANGED | NO FLANGE | |
| MC6 MC 706114 MC 6 2 cyl. | \varnothing 70.50 CD 27.0 TL 55.3 | 3 - 2.4 2 - 4.8 | \varnothing 13.495 TL 62.99 | | | | TEIKIN NO. |
|  | TEIKIN NO. | | TEIKIN NO. | | | | |
| | G9110 | | P G9109 | | | | |
| Surface Treatment Bore Clearance None MRC: 0.056 mm MP: 2.25 mm | REFERENCE NO. | | | | | | |
| 6D16 1 cyl. | \varnothing 80.00 CD 29.4 TL 60.4 | 3 - 3.0 1 - 4.0 | \varnothing 16.000 TL 71.00  | | | | TEIKIN NO. |
|  | TEIKIN NO. | | TEIKIN NO. | | | | |
| | G9112 | | P G9112 | | | | |
| Surface Treatment Bore Clearance None MRC: 0.080 mm MP: - mm | REFERENCE NO. | | ME713143 | | | | |
| 6D16T 1 cyl. | \varnothing 80.00 CD 29.4 TL 60.4 | 3 - 3.0 1 - 4.0 | \varnothing 16.000 TL 71.00  | | | | TEIKIN NO. |
|  | TEIKIN NO. | | TEIKIN NO. | | | | |
| | G9113 | | P G9112 | | | | |
| Surface Treatment Bore Clearance None MRC: 0.080 mm MP: - mm | REFERENCE NO. | | ME713171 | | | | |
| MC1 1 cyl. | \varnothing 92.08 CD 33.5 TL 72.9 | 2 - 3.2 1 - 4.8 | \varnothing 17.473 TL 69.85  | | | | TEIKIN NO. |
|  | TEIKIN NO. | | TEIKIN NO. | | | | |
| | G9102 | | P G9102 | | | | |
| Surface Treatment Bore Clearance None MRC: 0.096 mm MP: 25.50 mm | REFERENCE NO. | | | | | | |







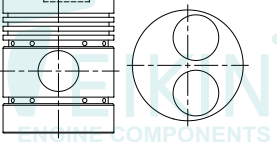

| ENGINE TYPE | PISTON | PISTON RING | PISTON PIN | PIN BUSHING | LINER | | LINER KIT SET |
|---|--|--------------------|---|-------------|---------|-----------|-------------------|
| | | | | | FLANGED | NO FLANGE | |
| MC4 1 cyl.  | \varnothing 98.35 CD 33.5 TL 68.6 | 3 - 2.0 1 - 4.0 | \varnothing 17.473 TL 69.85  | | | | TEIKIN NO. |
| | TEIKIN NO. G9108 | | TEIKIN NO. P G9102 | | | | |
| | REFERENCE NO. | | | | | | |
| Surface Treatment None | Bore Clearance MRC: 0.055 mm MP: 21.00 mm | | | | | | |
| | | | | | | | 9 |

SUITABLE FOR

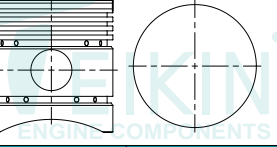
KUBOTA

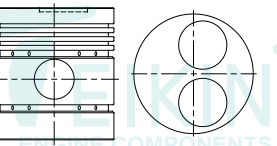
STATIONERY &
AGRICULTURE

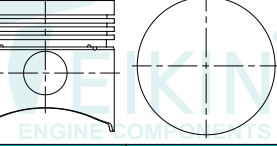

| ENGINE TYPE | PISTON | PISTON RING | PISTON PIN | PIN BUSHING | LINER | | LINER KIT SET | |
|---|--|-----------------------|--|-------------|---------|-----------|---|---|
| | | | | | FLANGED | NO FLANGE | | |
| KND3B 1 cyl.  | \varnothing 68.00 CD 44.8 TL 82.9 | 3 - 2.5 2 - 4.0 | \varnothing 25.00 TL 58.00  | | | | TEIKIN NO. REFERENCE NO. 14111-21113 14111-21112 | 1 |
| | TEIKIN NO. G0101 | TEIKIN NO. P G0101 | | | | | | |
| | REFERENCE NO. 14111-21113 14111-21112 | | | | | | | |
| | Surface Treatment Bore Clearance None MRC: 0.060 mm MP: 9.00 mm | | | | | | | |
| GA70 GA 120 1 cyl.  | \varnothing 75.00 CD 43.0 TL 81.0 | 3 - 2.5 2 - 4.0 | \varnothing 25.00 TL 65.00  | | | | TEIKIN NO. REFERENCE NO. 14441-21110 14441-21112 | 2 |
| | TEIKIN NO. G0120 | TEIKIN NO. P G0120 | | | | | | |
| | REFERENCE NO. 14441-21110 14441-21112 | | | | | | | |
| | Surface Treatment Bore Clearance None MRC: 0.100 mm MP: 12.00 mm | | | | | | | |
| KND40 1 cyl.  | \varnothing 75.00 CD 44.9 TL 82.9 | 3 - 2.5 2 - 4.0 | \varnothing 25.00 TL 65.00  | | | | TEIKIN NO. REFERENCE NO. 14109-21112 | 3 |
| | TEIKIN NO. G0116 | TEIKIN NO. P G0120 | | | | | | |
| | REFERENCE NO. 14109-21112 | | | | | | | |
| | Surface Treatment Bore Clearance None MRC: 0.150 mm MP: 17.00 mm | | | | | | | |
| RD55 1 cyl.  | \varnothing 76.00 CD 40.0 TL 72.1 | 3 - 2.0 1 - 4.0 | \varnothing 24.00 TL 65.00  | | | | TEIKIN NO. REFERENCE NO. | 4 |
| | TEIKIN NO. G0123 | TEIKIN NO. P G0123 | | | | | | |
| | REFERENCE NO. | | | | | | | |
| | Surface Treatment Bore Clearance None MRC: 0.100 mm MP: 16.50 mm | | | | | | | |

| ENGINE TYPE | PISTON | PISTON RING | PISTON PIN | PIN BUSHING | LINER | | LINER KIT SET |
|------------------------------|---|----------------------------------|--------------------------------------|-------------|---------|-----------|---------------------|
| | | | | | FLANGED | NO FLANGE | |
| JD75 1 cyl. | \varnothing 78.00 -12.85 CD 43.2 TL 77.2 | 1 - 2.5 HK 2 - 2.0 1 - 4.0 | \varnothing 25.000 TL 65.00 | | | | TEIKIN NO. 5 |
| | TEIKIN NO. G0112 | TEIKIN NO. P G0120 | | | | | |
| | REFERENCE NO. | | | | | | |
| | Surface Treatment Bore Clearance None MRC: 0.100 mm MP: 18.00 mm | | | | | | |
| KND 70A 1 cyl. | \varnothing 78.00 CD 43.0 TL 77.0 | 3 - 2.0 1 - 4.0 | \varnothing 25.000 TL 65.00 | | | | TEIKIN NO. 6 |
| | TEIKIN NO. G0103 | TEIKIN NO. P G0120 | | | | | |
| | REFERENCE NO. | | | | | | |
| | Surface Treatment Bore Clearance None MRC: 0.100 mm MP: 18.00 mm | | | | | | |
| KND 5B 1 cyl. | \varnothing 80.00 CD 45.0 TL 88.0 | 3 - 2.5 2 - 4.0 | \varnothing 26.000 TL 68.00 | | | | TEIKIN NO. 7 |
| | TEIKIN NO. G0102 | TEIKIN NO. P 44603 | | | | | |
| | REFERENCE NO. | | | | | | |
| | Surface Treatment Bore Clearance None MRC: 0.155 mm MP: 15.00 mm | | | | | | |
| RD 65 1 cyl. | \varnothing 80.00 CD 40.1 TL 72.1 | 3 - 2.0 1 - 4.0 | \varnothing 24.000 TL 65.00 | | | | TEIKIN NO. 8 |
| | TEIKIN NO. G0111 | TEIKIN NO. P G0111 | | | | | |
| | REFERENCE NO. 11131-21111 | | | | | | |
| | Surface Treatment Bore Clearance None MRC: 0.105 mm MP: 16.00 mm | | | | | | |







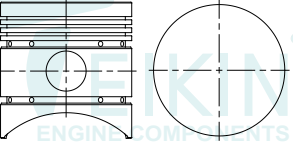

K

SUITABLE FOR

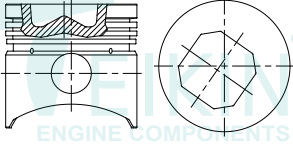
KUBOTA

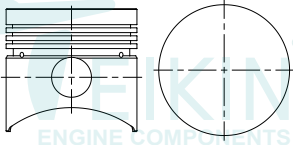
STATIONERY &
AGRICULTURE

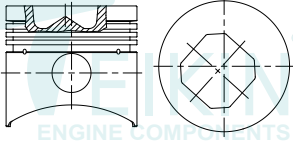

| ENGINE TYPE | PISTON | PISTON RING | PISTON PIN | PIN BUSHING | LINER | | LINER KIT SET |
|--|--|----------------------------------|---|-------------|---------|-----------|----------------------|
| | | | | | FLANGED | NO FLANGE | |
| GA80 1 cyl.  | \varnothing 82.00 CD 42.8 TL 85.0 | 3 - 2.0 2 - 4.0 | \varnothing 25.000 TL 70.00  | | | | TEIKIN NO. 9 |
| | TEIKIN NO. G0113 | | TEIKIN NO. P G0118 | | | | |
| | REFERENCE NO. 14351-22221 14351-21112 | | | | | | |
| | Surface Treatment: None Bore Clearance: MRC: 0.100 mm MP: 19.00 mm | | | | | | |
| RD 75 1 cyl.  | \varnothing 82.00 CD 43.2 TL 77.2 | 1 - 2.5 HK 2 - 2.0 1 - 4.5 | \varnothing 25.000 TL 64.00  | | | | TEIKIN NO. 10 |
| | TEIKIN NO. G0121 | | TEIKIN NO. P 42601 | | | | |
| | REFERENCE NO. | | | | | | |
| | Surface Treatment: None Bore Clearance: MRC: 0.080 mm MP: 18.00 mm | | | | | | |
| KND 80 1 cyl.  | \varnothing 84.00 CD 43.1 TL 77.1 | 3 - 2.0 1 - 4.5 | \varnothing 25.000 TL 70.00  | | | | TEIKIN NO. 11 |
| | TEIKIN NO. G0104 | | TEIKIN NO. P G0118 | | | | |
| | REFERENCE NO. 14911-2111 | | | | | | |
| | Surface Treatment: None Bore Clearance: MRC: 0.110 mm MP: 18.00 mm | | | | | | |
| KND 85 1 cyl.  | \varnothing 84.00 CD 43.3 TL 77.3 | 1 - 2.0 HK 2 - 2.0 1 - 4.5 | \varnothing 25.000 TL 70.00  | | | | TEIKIN NO. 12 |
| | TEIKIN NO. G0106 | | TEIKIN NO. P G0118 | | | | |
| | REFERENCE NO. | | | | | | |
| | Surface Treatment: None Bore Clearance: MRC: 0.091 mm MP: 18.00 mm | | | | | | |

| ENGINE TYPE | PISTON | PISTON RING | PISTON PIN | PIN BUSHING | LINER | | LINER KIT SET |
|---|---|----------------------------------|--------------------------------------|-------------|---------|-----------|------------------------------|
| | | | | | FLANGED | NO FLANGE | |
| KND 95Di 1 cyl. Surface Treatment: Tin Coated Bore Clearance: MRC: 0.090 mm, MP: 23.50 mm | \varnothing 86.00 -14.5 CD 47.2 TL 88.0 | 1 - 2.5 HK 2 - 2.0 1 - 4.5 | \varnothing 27.000 TL 72.00 | | | | TEIKIN NO. 13 |
| | TEIKIN NO. G0119 | TEIKIN NO. P 39125 | | | | | |
| | REFERENCE NO. | | | | | | |
| | | | | | | | |
| RD 85 1 cyl. Surface Treatment: None Bore Clearance: MRC: 0.091 mm, MP: 22.20 mm | \varnothing 86.00 -14.2 CD 43.2 TL 77.2 | 1 - 2.5 HK 2 - 2.0 1 - 4.5 | \varnothing 25.000 TL 70.00 | | | | TEIKIN NO. 14 |
| | TEIKIN NO. G0118 | TEIKIN NO. P G0118 | | | | | |
| | REFERENCE NO. | | | | | | |
| | | | | | | | |
| RD85S 1 cyl. Surface Treatment: Tin Coated Bore Clearance: MRC: 0.090 mm, MP: 15.50 mm | \varnothing 88.00 -16.7 CD 43.2 TL 75.2 | 1 - 2.5 HK 2 - 2.0 1 - 4.5 | \varnothing 25.000 TL 70.00 | | | | TEIKIN NO. 15 |
| | TEIKIN NO. G0124 | TEIKIN NO. P G0118 | | | | | |
| | REFERENCE NO. | | | | | | |
| | | | | | | | |
| GA 90 ER 65 1 cyl. Surface Treatment: None Bore Clearance: MRC: 0.090 mm, MP: 23.50 mm | \varnothing 90.00 CD 48.4 TL 95.4 | 3 - 2.5 2 - 4.0 | \varnothing 28.000 TL 74.00 | | | | TEIKIN NO. 16 |
| | TEIKIN NO. G0114 | TEIKIN NO. P G0114 | | | | | |
| | REFERENCE NO. 14301-21112 | | | | | | |
| | | | | | | | |









K

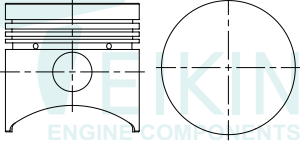

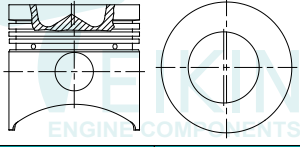

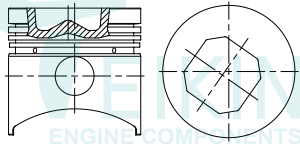

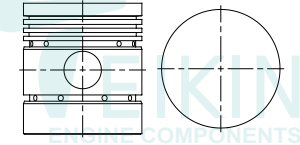

SUITABLE FOR

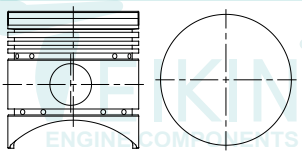
KUBOTA

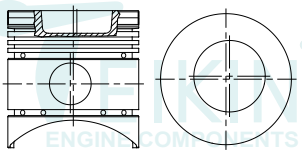

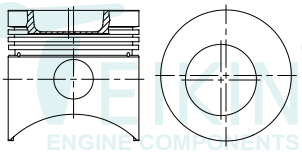

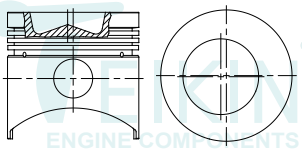
STATIONERY &
AGRICULTURE





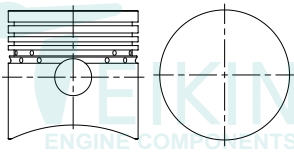

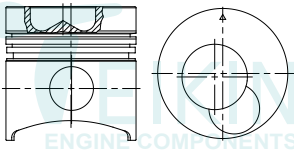



| ENGINE TYPE | PISTON | PISTON RING | PISTON PIN | PIN BUSHING | LINER | | LINER KIT SET |
|--|---|----------------------------------|---|-------------|---------|-----------|------------------------------|
| | | | | | FLANGED | NO FLANGE | |
| KND 105 1 cyl.  | \varnothing 92.00 CD 47.0 TL 88.0 | 1 - 2.5 2 - 2.0 1 - 4.5 | \varnothing 27.000 TL 72.00  | | | | TEIKIN NO. 17 |
| | TEIKIN NO. G0107 | | TEIKIN NO. P 39125 | | | | |
| | REFERENCE NO. 14931-2111 | | | | | | |
| | Surface Treatment Bore Clearance None MRC: 0.110 mm MP: 23.00 mm | | | | | | |
| KND 110 1 cyl.  | \varnothing 92.00 CD 47.1 TL 87.9 | 1 - 2.5 HK 2 - 2.0 1 - 4.5 | \varnothing 27.000 TL 72.00  | | | | TEIKIN NO. 18 |
| | TEIKIN NO. G0108 | | TEIKIN NO. P 39125 | | | | |
| | REFERENCE NO. | | | | | | |
| | Surface Treatment Bore Clearance Tin Coated MRC: 0.090 mm MP: 22.50 mm | | | | | | |
| RD 105 1 cyl.  | \varnothing 92.00 CD 47.2 TL 88.2 | 1 - 2.5 HK 2 - 2.0 1 - 4.5 | \varnothing 27.000 TL 72.00  | | | | TEIKIN NO. 19 |
| | TEIKIN NO. G0122 | | TEIKIN NO. P 39125 | | | | |
| | REFERENCE NO. | | | | | | |
| | Surface Treatment Bore Clearance None MRC: 0.100 mm MP: 22.80 mm | | | | | | |
| KND 90/120 1 cyl.  | \varnothing 95.00 CD 53.6 TL 105.1 | 1 - 3.0 HK 2 - 3.0 2 - 5.0 | \varnothing 30.000 TL 80.00  | | | | TEIKIN NO. 20 |
| | TEIKIN NO. G0105 | | TEIKIN NO. P 44654 | | | | |
| | REFERENCE NO. | | | | | | |
| | Surface Treatment Bore Clearance None MRC: 0.100 mm MP: 13.00 mm | | | | | | |

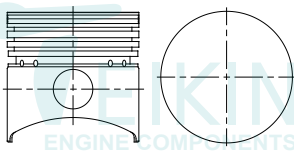

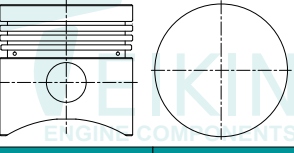

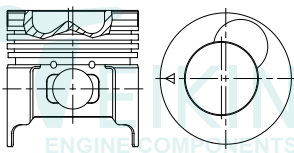

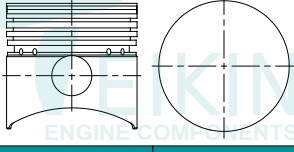

| ENGINE TYPE | PISTON | PISTON RING | PISTON PIN | PIN BUSHING | LINER | | LINER KIT SET |
|---|---|----------------------------------|---|-------------|---------|-----------|---------------|
| | | | | | FLANGED | NO FLANGE | |
| KND 180 1 cyl.  | \varnothing 110.00 CD 61.3 TL 115.0 | 1 - 3.0 HK 2 - 3.0 2 - 5.0 | \varnothing 35.000 TL 95.00  | | | | TEIKIN NO. |
| | TEIKIN NO. | | TEIKIN NO. | | | | |
| | G0109 | | P G0109 | | | | |
| | REFERENCE NO. | | | | | | |
| Surface Treatment None | Bore Clearance MRC: 0.100 mm MP: 25.00 mm | | | | | | 21 |
| KND 190 1 cyl.  | \varnothing 110.00 -19.0 CD 61.2 TL 115.3 | 1 - 2.5 HK 2 - 3.0 2 - 5.0 | \varnothing 35.000 TL 95.00  | | | | TEIKIN NO. |
| | TEIKIN NO. | | TEIKIN NO. | | | | |
| | G0110 | | P G0109 | | | | |
| | REFERENCE NO. | | | | | | |
| Surface Treatment None | Bore Clearance MRC: 0.120 mm MP: 24.00 mm | | | | | | 22 |
| KND 220 1 cyl.  | \varnothing 116.00 -19.0 CD 61.3 TL 115.3 | 1 - 3.0 HK 2 - 2.5 1 - 5.0 | \varnothing 35.000 TL 95.00  | | | | TEIKIN NO. |
| | TEIKIN NO. | | TEIKIN NO. | | | | |
| | G0115 | | P G0109 | | | | |
| | REFERENCE NO. | | | | | | |
| Surface Treatment Tin Coated | Bore Clearance MRC: 0.130 mm MP: 30.00 mm | | | | | | 23 |
| KND 250 1 cyl.  | \varnothing 118.00 -19.6 CD 59.7 TL 113.8 | 1 - 3.2 HK 2 - 2.5 1 - 5.0 | \varnothing 35.000 TL 95.00  | | | | TEIKIN NO. |
| | TEIKIN NO. | | TEIKIN NO. | | | | |
| | G0117 | | P G0109 | | | | |
| | REFERENCE NO. | | | | | | |
| Surface Treatment Tin Coated | Bore Clearance MRC: 0.170 mm MP: 32.00 mm | | | | | | 24 |

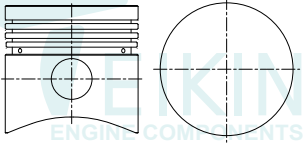
K

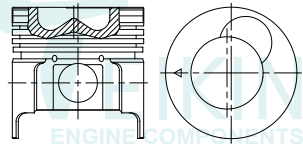

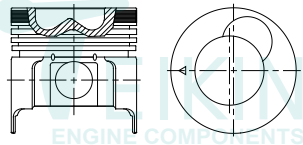

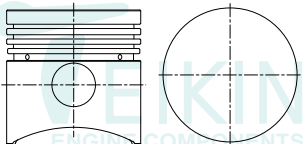



| ENGINE TYPE | PISTON | PISTON RING | PISTON PIN | PIN BUSHING | LINER | | LINER KIT SET |
|---|---|----------------------------------|---|-------------|---------|-----------|-----------------------------|
| | | | | | FLANGED | NO FLANGE | |
| MN 110 1 cyl.  | \varnothing 88.00 CD 45.2 TL 87.2 | 3 - 2.5 HK 1 - 4.0 | \varnothing 25.000 TL 67.00  | | | | TEIKIN NO. 5 |
| | TEIKIN NO. G2103 | | TEIKIN NO. P 39157 | | | | |
| | REFERENCE NO. | | | | | | |
| | Surface Treatment Bore Clearance None MRC: - mm MP: - mm | | | | | | |
| MN 240 1 cyl.  | \varnothing 113.00 -21.2 CD 71.0 TL 116.0 | 1 - 3.0 HK 1 - 2.5 1 - 5.0 | \varnothing 38.000 TL 90.00  | | | | TEIKIN NO. 6 |
| | TEIKIN NO. G2102 | | TEIKIN NO. P 43101 | | | | |
| | REFERENCE NO. MM 334687 | | | | | | |
| | Surface Treatment Bore Clearance Tin Coated MRC: - mm MP: - mm | | | | | | |

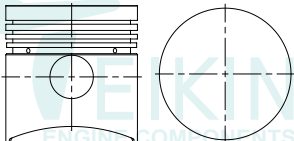

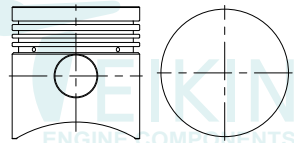

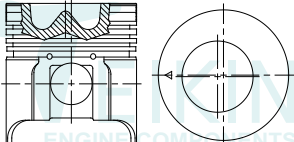

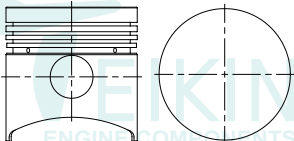

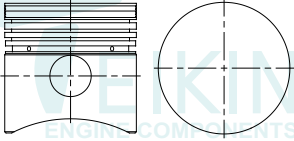

| ENGINE TYPE | PISTON | PISTON RING | PISTON PIN | PIN BUSHING | LINER | | LINER KIT SET |
|--|---|--------------------|---|-------------|---------|-----------|---------------|
| | | | | | FLANGED | NO FLANGE | |
| TS 50 1 cyl.  Surface Treatment Bore Clearance None MRC: 0.098 mm MP: 15.20 mm | \emptyset 70.00 CD 40.9 TL 69.0 | 3 - 2.0 1 - 4.0 | \emptyset 21.000 TL 59.00  | | | | TEIKIN NO. |
| | TEIKIN NO. | | TEIKIN NO. | | | | |
| | G1101 | | P 45131 | | | | |
| | REFERENCE NO. 105140-22020 | | | | | | |
| TS 50-II 1 cyl.  Surface Treatment Bore Clearance None MRC: 0.090 mm MP: 13.50 mm | \emptyset 70.00 CD 41.0 TL 69.0 | 3 - 2.0 1 - 4.0 | \emptyset 21.000 TL 59.00  | | | | TEIKIN NO. |
| | TEIKIN NO. | | TEIKIN NO. | | | | |
| | G1603 | | P 45131 | | | | |
| | REFERENCE NO. 104100-22090 | | | | | | |
| TF 55 1 cyl.  Surface Treatment Bore Clearance None MRC: 0.090 mm MP: 19.00 mm | \emptyset 75.00 CD 44.8 TL 77.8 -13.2 | 3 - 2.0 1 - 4.0 | \emptyset 23.000 TL 60.00  | | | | TEIKIN NO. |
| | TEIKIN NO. | | TEIKIN NO. | | | | |
| | G1118 | | P G1118 | | | | |
| | REFERENCE NO. 105100-22091 | | | | | | |
| TS 60 1 cyl.  Surface Treatment Bore Clearance None MRC: 0.094 mm MP: 15.50 mm | \emptyset 75.00 CD 41.5 TL 72.0 | 3 - 2.0 1 - 4.0 | \emptyset 23.000 TL 63.00  | | | | TEIKIN NO. |
| | TEIKIN NO. | | TEIKIN NO. | | | | |
| | G1102 | | P G1102 | | | | |
| | REFERENCE NO. 105240-22020C | | | | | | |

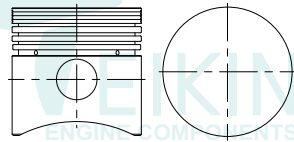
| ENGINE TYPE | PISTON | PISTON RING | PISTON PIN | PIN BUSHING | LINER | | LINER KIT SET |
|--|---|------------------------|---|-------------|---------|-----------|-----------------------------------|
| | | | | | FLANGED | NO FLANGE | |
| TS 60-II 1 cyl.  | \emptyset 75.00 CD 41.5 TL 72.0 | 3 - 2.0 1 - 4.0 | \emptyset 23.000 TL 63.00  | | | | TEIKIN NO. 5 |
| | TEIKIN NO. | | TEIKIN NO. | | | | |
| | G1604 | | P G1102 | | | | |
| | REFERENCE NO. 104200-22090 | | | | | | |
| Surface Treatment None Bore Clearance MRC: 0.110 mm MP: 13.50 mm | | | | | | | |
| TF 65 1 cyl.  | \emptyset 78.00 -13.7 CD 44.8 TL 77.8 | 3 - 2.0 1 - 4.0 | \emptyset 23.000 TL 60.00  | | | | TEIKIN NO. 6 |
| | TEIKIN NO. | | TEIKIN NO. | | | | |
| | G1111 | | P G1111 | | | | |
| | REFERENCE NO. | | | | | | |
| Surface Treatment None Bore Clearance MRC: 0.110 mm MP: 19.25 mm | | | | | | | |
| TF 65-II 1 cyl.  | \emptyset 78.00 -13.7 CD 44.8 TL 77.8 | 3 - 2.0 1 - 4.0 | \emptyset 23.000 TL 60.00  | | | | TEIKIN NO. 7 |
| | TEIKIN NO. | | TEIKIN NO. | | | | |
| | G1120 | | P G1118 | | | | |
| | REFERENCE NO. | | | | | | |
| Surface Treatment None Bore Clearance MRC: 0.110 mm MP: 19.25 mm | | | | | | | |
| TS 70-II 1 cyl.  | \emptyset 79.90 CD 44.5 TL 80.0 | 3 - 2.5 1 - 4.0 | \emptyset 26.000 TL 66.00  | | | | TEIKIN NO. 8 |
| | TEIKIN NO. | | TEIKIN NO. | | | | |
| | G1605 | | P G1113 | | | | |
| | REFERENCE NO. 104300-22090 | | | | | | |
| Surface Treatment None Bore Clearance MRC: 0.040 mm MP: 17.50 mm | | | | | | | |

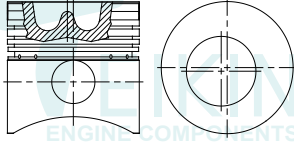
| ENGINE TYPE | PISTON | PISTON RING | PISTON PIN | PIN BUSHING | LINER | | LINER KIT SET |
|---------------------------|---|--------------------|--------------------------------|-------------|---------|-----------|---------------|
| | | | | | FLANGED | NO FLANGE | |
| TF 75 1 cyl. | Ø 80.00 -16.0 CD 49.3 TL 85.8 | 3 - 2.5 1 - 4.0 | Ø 26.000 TL 65.50 | | | | TEIKIN NO. |
| | TEIKIN NO. G1112 | | TEIKIN NO. P G1112 | | | | |
| Surface Treatment None | Bore Clearance MRC: 0.110 mm MP: 20.25 mm | | REFERENCE NO. | | | | 9 |
| TS 70 1 cyl. | Ø 80.00 CD 44.5 TL 80.0 | 3 - 2.5 1 - 4.0 | Ø 26.000 TL 66.00 | | | | TEIKIN NO. |
| | TEIKIN NO. G1103 | | TEIKIN NO. P G1113 | | | | |
| Surface Treatment None | Bore Clearance MRC: 0.095 mm MP: 16.25 mm | | REFERENCE NO. 10811-22111 | | | | 10 |
| TF 85 1 cyl. | Ø 85.00 -15.9 CD 49.3 TL 85.8 | 3 - 2.5 1 - 4.0 | Ø 26.000 TL 66.00 | | | | TEIKIN NO. |
| | TEIKIN NO. G1113 | | TEIKIN NO. P G1113 | | | | |
| Surface Treatment None | Bore Clearance MRC: 0.120 mm MP: 18.00 mm | | REFERENCE NO. 1054002-22020 | | | | 11 |
| TF 85-II 1 cyl. | Ø 85.00 -15.9 CD 49.3 TL 85.8 | 3 - 2.5 1 - 4.0 | Ø 26.000 TL 66.00 | | | | TEIKIN NO. |
| | TEIKIN NO. G1115 | | TEIKIN NO. P G1113 | | | | |
| Surface Treatment None | Bore Clearance MRC: 0.120 mm MP: 18.00 mm | | REFERENCE NO. | | | | 12 |

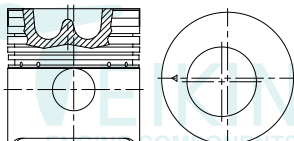
| ENGINE TYPE | PISTON | PISTON RING | PISTON PIN | PIN BUSHING | LINER | | LINER KIT SET |
|--|---|------------------------|---|-------------|---------|-----------|---------------|
| | | | | | FLANGED | NO FLANGE | |
| TS 105 1 cyl.  | \emptyset 85.00 CD 46.0 TL 88.0 | 3 - 2.5 1 - 4.0 | \emptyset 28.000 TL 71.00  | | | | TEIKIN NO. |
| | TEIKIN NO. | | TEIKIN NO. | | | | |
| | G1104 | | P G1104 | | | | |
| | REFERENCE NO. | | | | | | |
| Surface Treatment None Bore Clearance MRC: 0.110 mm MP: 18.00 mm | | | | | | | 13 |
| TS 105-II 1 cyl.  | \emptyset 85.00 CD 46.0 TL 88.0 | 3 - 2.5 1 - 4.0 | \emptyset 28.000 TL 71.00  | | | | TEIKIN NO. |
| | TEIKIN NO. | | TEIKIN NO. | | | | |
| | G1601 | | P 44684 | | | | |
| | REFERENCE NO. | | | | | | |
| Surface Treatment None Bore Clearance MRC: 0.110 mm MP: 18.00 mm | | | | | | | 14 |
| TF 105 1 cyl.  | \emptyset 88.00 CD 54.3 TL 96.8 -17.6 | 3 - 2.5 1 - 4.0 | \emptyset 28.000 TL 70.00  | | | | TEIKIN NO. |
| | TEIKIN NO. | | TEIKIN NO. | | | | |
| | G1114 | | P G1114 | | | | |
| | REFERENCE NO. | | | | | | |
| Surface Treatment None Bore Clearance MRC: 0.136 mm MP: 24.00 mm | | | | | | | 15 |
| TS 130 1 cyl.  | \emptyset 92.00 CD 48.8 TL 94.1 | 3 - 2.5 1 - 4.0 | \emptyset 30.000 TL 73.00  | | | | TEIKIN NO. |
| | TEIKIN NO. | | TEIKIN NO. | | | | |
| | G1105 | | P G1105 | | | | |
| | REFERENCE NO. | | | | | | |
| Surface Treatment None Bore Clearance MRC: 0.140 mm MP: 23.65 mm | | | | | | | 16 |



| ENGINE TYPE | PISTON | PISTON RING | PISTON PIN | PIN BUSHING | LINER | | LINER KIT SET |
|--|---|------------------------|---|-------------|---------|-----------|--|
| | | | | | FLANGED | NO FLANGE | |
| TS 180 1 cyl.  | \emptyset 102.00 CD 56.3 TL 100.5 | 3 - 2.5 1 - 4.5 | \emptyset 32.000 TL 80.00  | | | | TEIKIN NO. 21 |
| | TEIKIN NO. | | TEIKIN NO. | | | | |
| | G1107 | | P G1106 | | | | |
| | REFERENCE NO. 104800-22021 | | | | | | |
| Surface Treatment None Bore Clearance MRC: 0.160 mm MP: 19.60 mm | | | | | | | |
| TS 180-II 1 cyl.  | \emptyset 102.00 CD 56.5 TL 100.5 | 3 - 2.5 1 - 4.5 | \emptyset 32.000 TL 80.80  | | | | TEIKIN NO. 22 |
| | TEIKIN NO. | | TEIKIN NO. | | | | |
| | G1602 | | P G1602 | | | | |
| | REFERENCE NO. 104800-11091 | | | | | | |
| Surface Treatment None Bore Clearance MRC: 0.150 mm MP: 19.60 mm | | | | | | | |
| TS 190 1 cyl.  | \emptyset 109.90 -24.0 CD 66.7 TL 109.5 | 3 - 2.5 1 - 4.5 | \emptyset 36.000 TL 89.50  | | | | TEIKIN NO. 23 |
| | TEIKIN NO. | | TEIKIN NO. | | | | |
| | G1108 | | P G1108 | | | | |
| | REFERENCE NO. 105890-22020 | | | | | | |
| Surface Treatment None Bore Clearance MRC: 0.065 mm MP: 19.35 mm | | | | | | | |
| TS 230 1 cyl.  | \emptyset 112.00 -26.0 CD 68.7 TL 118.0 | 3 - 2.5 1 - 4.5 | \emptyset 36.000 TL 89.30  | | | | TEIKIN NO. 24 |
| | TEIKIN NO. | | TEIKIN NO. | | | | |
| | G1109 | | P G1109 | | | | |
| | REFERENCE NO. 105990-22021 | | | | | | |
| Surface Treatment None Bore Clearance MRC: 0.180 mm MP: 19.65 mm | | | | | | | |

SUITABLE FOR

YANMAR

STATIONERY &
AGRICULTURE

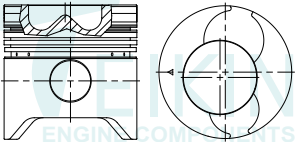

| ENGINE TYPE | PISTON | PISTON RING | PISTON PIN | PIN BUSHING | LINER | | LINER KIT SET |
|--|---|--------------------|---|-------------|---------|-----------|--|
| | | | | | FLANGED | NO FLANGE | |
| TF 300 1 cyl.  | \varnothing 125.00 -23.8 CD 71.5 TL 126.5 | 3 - 2.5 1 - 5.0 | \varnothing 38.000 TL 98.00  | | | | TEIKIN NO. G1117 G1117A REFERENCE NO. 105950-22092 |
| Surface Treatment None | Bore Clearance MRC: 0.170 mm MP: 27.50 mm | | TEIKIN NO. P G1117 | | | | 25 |

| ENGINE TYPE | PISTON | PISTON RING | PISTON PIN | PIN BUSHING | LINER | | LINER KIT SET |
|--|--|-------------------------|----------------------------------|-------------|---------|-----------|---------------|
| | | | | | FLANGED | NO FLANGE | |
| CROSS FLOW 2.1880" 9.9 - 15 HP 2 cyl. | \varnothing 55.58 +14.8 CD 24.9 TL 63.8 | 1 - 2.0 HK 1 - 1.6 | \varnothing 14.260 TL 46.00 | | | | TEIKIN NO. |
| | TEIKIN NO. M3101 | | TEIKIN NO. P M3101 | | | | |
| | REFERENCE NO. | | | | | | |
| | Surface Treatment Bore Clearance Tin Coated MRC: 0.080 mm MP: 3.00 mm | | | | | | |
| CROSS FLOW 3.0000" 20 - 35 HP 2 cyl. | \varnothing 76.20 +16.1 CD 39.6 TL 81.0 | 1 - 2.5 HK 1 - 1.6 | \varnothing 19.050 TL 67.20 | | | | TEIKIN NO. |
| | TEIKIN NO. M3103 | | TEIKIN NO. P M3102 | | | | |
| | REFERENCE NO. | | | | | | |
| | Surface Treatment Bore Clearance Tin Coated MRC: 0.080 mm MP: 2.00 mm | | | | | | |
| LOOPER 3.0000" 60 - 75 HP 3 cyl. | \varnothing 76.20 CD 38.3 TL 63.4 | 1 - 2.5 HK 1 - 1.6 | \varnothing 19.050 TL 67.20 | | | | TEIKIN NO. |
| | TEIKIN NO. M3102 | | TEIKIN NO. P M3102 | | | | |
| | REFERENCE NO. | | | | | | |
| | Surface Treatment Bore Clearance Tin Coated MRC: 0.195 mm MP: 6.50 mm | | | | | | |
| LOOPER 3.1875" 35 - 60 HP 2 cyl. | \varnothing 80.96 CD 36.0 TL 75.5 | 1 - 2.54 HK 1 - 1.59 | \varnothing 19.050 TL 71.20 | | | | TEIKIN NO. |
| | TEIKIN NO. M3105 | | TEIKIN NO. P M3104 | | | | |
| | REFERENCE NO. | | | | | | |
| | Surface Treatment Bore Clearance Tin Coated MRC: 0.070 mm MP: 2.00 mm | | | | | | |

SUITABLE FOR





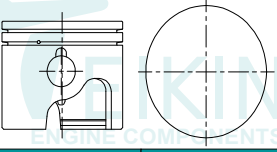
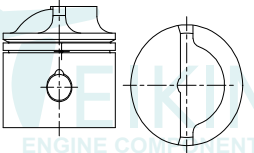
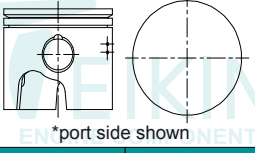
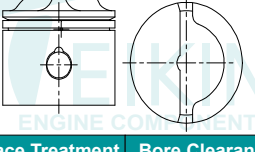

JOHNSON

MARINE ENGINE

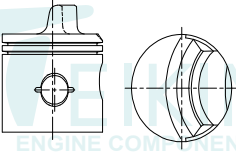

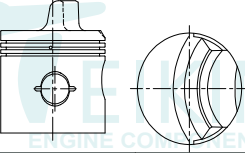
| ENGINE TYPE | PISTON | PISTON RING | PISTON PIN | PIN BUSHING | LINER | | LINER KIT SET |
|--|---|-------------------------|----------------------------------|-------------|---------|-----------|---------------|
| | | | | | FLANGED | NO FLANGE | |
| LOOPER 50, 60, 65 - 70 HP 3 cyl. | \varnothing 80.96 CD 30.5 TL 66.0 | 2 - 2.0 HK | \varnothing 19.050 TL 71.20 | | | | TEIKIN NO. |
|  | | | | | | | |
| TEIKIN NO. M3104 | | | TEIKIN NO. P M3104 | | | | |
| REFERENCE NO. | | | | | | | |
| Surface Treatment Tin Coated | Bore Clearance MRC: 0.105 mm MP: 6.00 mm | | | | | | 5 |
| CROSS FLOW 3.5000" 85 - 300 HP V4 4 cyl. | \varnothing 88.90 +19.6 CD 39.9 TL 89.2 | 1 - 2.54 HK 1 - 1.59 | \varnothing 19.050 TL 79.20 | | | | TEIKIN NO. |
|  | | | | | | | |
| TEIKIN NO. M3107 | | | TEIKIN NO. P M3107 | | | | |
| REFERENCE NO. | | | | | | | |
| Surface Treatment Tin Coated | Bore Clearance MRC: 0.095 mm MP: 2.00 mm | | | | | | 6 |
| LOOPER 3.5000" 120 - 300 HP V4 4 cyl. | \varnothing 88.90 CD 35.3 TL 78.3 | 1 - 2.54 HK 1 - 1.59 | \varnothing 24.000 TL 77.50 | | | | TEIKIN NO. |
|  | | | | | | | |
| *port side shown | | | | | | | |
| TEIKIN NO. M3106P M3106S | | | TEIKIN NO. P M3106P | | | | |
| REFERENCE NO. | | | | | | | |
| Surface Treatment Tin Coated | Bore Clearance MRC: 0.090 mm MP: 2.00 mm | | | | | | 7 |
| CROSS FLOW 3.5000" 85 - 300 HP V6 6 cyl. | \varnothing 88.90 +19.6 CD 39.9 TL 89.2 | 1 - 2.54 HK 1 - 1.59 | \varnothing 19.050 TL 79.20 | | | | TEIKIN NO. |
|  | | | | | | | |
| TEIKIN NO. M3107-6 | | | TEIKIN NO. P M3107 | | | | |
| REFERENCE NO. | | | | | | | |
| Surface Treatment Tin Coated | Bore Clearance MRC: 0.095 mm MP: 2.00 mm | | | | | | 8 |

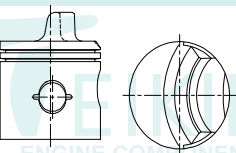

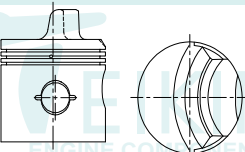



| ENGINE TYPE | PISTON | PISTON RING | PISTON PIN | PIN BUSHING | LINER | | LINER KIT SET |
|---|---|-------------------------|--------------------------------|-------------|---------|-----------|---------------|
| | | | | | FLANGED | NO FLANGE | |
| CROSS FLOW 3.6250" 150 - 235 HP V6 6 cyl. | \emptyset 92.07 +19.6 CD 39.9 TL 89.2 | 1 - 2.54 HK 1 - 1.59 | \emptyset 19.050 TL 79.20 | | | | TEIKIN NO. |
| | TEIKIN NO. M3109 | | TEIKIN NO. P M3107 | | | | |
| | REFERENCE NO. | | | | | | |
| | Surface Treatment Bore Clearance Tin Coated MRC: 0.130 mm MP: 2.00 mm | | | | | | |
| 3.685" 1993 - 2000 90° (Finger Ported) V4 120, 125, 200 - 225 HP 4 cyl. | \emptyset 93.60 +3.9 CD 35.3 TL 81.0 | 2 - 2.0 HK | \emptyset 24.000 TL 77.50 | | | | TEIKIN NO. |
| | TEIKIN NO. M3110P M3110S | | TEIKIN NO. P M3106P | | | | |
| | REFERENCE NO. | | | | | | |
| | Surface Treatment Bore Clearance Tin Coated MRC: 0.080 mm MP: 11.15 mm | | | | | | |
| 3.685" 1993 - 2000 90° (Finger Ported) V6 120, 125, 200 - 225 HP 6 cyl. | \emptyset 93.60 +3.9 CD 35.3 TL 81.0 | 2 - 2.0 HK | \emptyset 24.000 TL 77.50 | | | | TEIKIN NO. |
| | TEIKIN NO. M3110P-6 M3110S-6 | | TEIKIN NO. P M3106P | | | | |
| | REFERENCE NO. | | | | | | |
| | Surface Treatment Bore Clearance Tin Coated MRC: 0.080 mm MP: 11.15 mm | | | | | | |
| 3.685" 1993 - 2000 90° (Finger Ported) V8 120, 125, 200 - 225 HP 8 cyl. | \emptyset 93.60 +3.9 CD 35.3 TL 81.0 | 2 - 2.0 HK | \emptyset 24.000 TL 77.50 | | | | TEIKIN NO. |
| | TEIKIN NO. M3110P-8 M3110S-8 | | TEIKIN NO. P M3106P | | | | |
| | REFERENCE NO. | | | | | | |
| | Surface Treatment Bore Clearance Tin Coated MRC: 0.080 mm MP: 11.15 mm | | | | | | |

| ENGINE TYPE | PISTON | PISTON RING | PISTON PIN | PIN BUSHING | LINER | | LINER KIT SET |
|---|---|----------------------|---|-------------|---------|-----------|---------------|
| | | | | | FLANGED | NO FLANGE | |
| HIGH DOME 2.8750" 35 - 140 HP 2 cyl. | \emptyset 73.03 +19.6 CD 38.0 TL 86.5 | 2 - 2.24 HK | \emptyset 19.550 TL 61.00  | | | | TEIKIN NO. |
|  | TEIKIN NO. M2103 | | TEIKIN NO. P M2101 | | | | |
| Surface Treatment Bore Clearance Tin Coated MRC: 0.085 mm MP: 1.50 mm | | | | | | | |
| | | | | | | | |
| HIGH DOME 2.8750"-II 35 - 140 HP 2 cyl. | \emptyset 73.03 +19.6 CD 38.0 TL 86.5 | 2 - 1.59 1 - 1.59 | \emptyset 19.550 TL 61.00  | | | | TEIKIN NO. |
|  | TEIKIN NO. M2104 | | TEIKIN NO. P M2101 | | | | |
| Surface Treatment Bore Clearance Tin Coated MRC: 0.085 mm MP: 1.50 mm | | | | | | | |
| | | | | | | | |
| HIGH DOME 2.8750" 35 - 140 HP 3 cyl. | \emptyset 73.03 +19.6 CD 38.0 TL 86.5 | 2 - 2.24 HK | \emptyset 19.550 TL 61.00  | | | | TEIKIN NO. |
|  | TEIKIN NO. M2103-3 | | TEIKIN NO. P M2101 | | | | |
| Surface Treatment Bore Clearance Tin Coated MRC: 0.085 mm MP: 1.50 mm | | | | | | | |
| | | | | | | | |
| HIGH DOME 2.8750"-II 35 - 140 HP 3 cyl. | \emptyset 73.03 +19.6 CD 38.0 TL 86.5 | 2 - 1.59 1 - 1.59 | \emptyset 19.550 TL 61.00  | | | | TEIKIN NO. |
|  | TEIKIN NO. M2104-3 | | TEIKIN NO. P M2101 | | | | |
| Surface Treatment Bore Clearance Tin Coated MRC: 0.085 mm MP: 1.50 mm | | | | | | | |
| | | | | | | | |

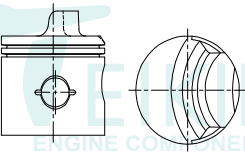
SUITABLE FOR
MERCURY

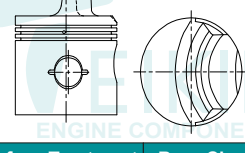

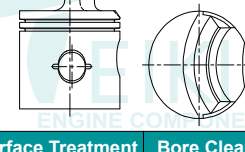
MARINE ENGINE

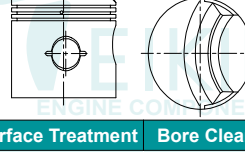

| ENGINE TYPE | PISTON | PISTON RING | PISTON PIN | PIN BUSHING | LINER | | LINER KIT SET |
|---|---|----------------------|---|-------------|---------|-----------|---------------|
| | | | | | FLANGED | NO FLANGE | |
| LOW DOME 2.8750" 50 - 150 HP 3 cyl. | \varnothing 73.03 +17.1 CD 38.0 TL 83.9 | 2 - 2.24 HK | \varnothing 19.550 TL 61.00  | | | | TEIKIN NO. |
|  | TEIKIN NO. M2101 | | TEIKIN NO. P M2101 | | | | |
| Surface Treatment Bore Clearance Tin Coated MRC: 0.085 mm MP: 1.50 mm | REFERENCE NO. | | | | | | |
| | | | | | | | |
| LOW DOME 2.8750"-II 50 - 150 HP 3 cyl. | \varnothing 73.03 +17.1 CD 38.0 TL 83.9 | 2 - 1.59 1 - 1.59 | \varnothing 19.550 TL 61.00  | | | | TEIKIN NO. |
|  | M2102 | | TEIKIN NO. P M2101 | | | | |
| Surface Treatment Bore Clearance Tin Coated MRC: 0.085 mm MP: 1.50 mm | REFERENCE NO. | | | | | | |
| | | | | | | | |
| HIGH DOME 2.8750" 35 - 140 HP 4 cyl. | \varnothing 73.03 +19.6 CD 38.0 TL 86.5 | 2 - 2.24 HK | \varnothing 19.550 TL 61.00  | | | | TEIKIN NO. |
|  | TEIKIN NO. M2103-4 | | TEIKIN NO. P M2101 | | | | |
| Surface Treatment Bore Clearance Tin Coated MRC: 0.085 mm MP: 1.50 mm | REFERENCE NO. | | | | | | |
| | | | | | | | |
| HIGH DOME 2.8750"-II 35 - 140 HP 4 cyl. | \varnothing 73.03 +19.6 CD 38.0 TL 86.5 | 2 - 1.59 1 - 1.59 | \varnothing 19.550 TL 61.00  | | | | TEIKIN NO. |
|  | TEIKIN NO. M2104-4 | | TEIKIN NO. P M2101 | | | | |
| Surface Treatment Bore Clearance Tin Coated MRC: 0.085 mm MP: 1.50 mm | REFERENCE NO. | | | | | | |
| | | | | | | | |

| ENGINE TYPE | PISTON | PISTON RING | PISTON PIN | PIN BUSHING | LINER | | LINER KIT SET |
|---|---|----------------------|--------------------------------|-------------|---------|-----------|---------------|
| | | | | | FLANGED | NO FLANGE | |
| HIGH DOME 2.8750" 35 - 140 HP 6 cyl. | \emptyset 73.03 +19.6 CD 38.0 TL 86.5 | 2 - 2.24 HK | \emptyset 19.550 TL 61.00 | | | | TEIKIN NO. |
| | TEIKIN NO. M2103-6 | | | | | | |
| Surface Treatment Bore Clearance Tin Coated MRC: 0.085 mm MP: 1.50 mm | | | | | | | |
| | REFERENCE NO. | | TEIKIN NO. P M2101 | | | | |
| HIGH DOME 2.8750"-II High Dome 2.8750" 35 - 140 HP 6 cyl. | \emptyset 73.03 +19.6 CD 38.0 TL 86.5 | 2 - 1.59 1 - 1.59 | \emptyset 19.550 TL 61.00 | | | | TEIKIN NO. |
| | TEIKIN NO. M2104-6 | | | | | | |
| Surface Treatment Tin Coated MRC: 0.085 mm MP: 1.50 mm | | | | | | | |
| | REFERENCE NO. | | TEIKIN NO. P M2101 | | | | |
| LOW DOME 2.8750" 50 - 150 HP 6 cyl. | \emptyset 73.03 +17.1 CD 38.0 TL 83.9 | 2 - 2.24 HK | \emptyset 19.550 TL 61.00 | | | | TEIKIN NO. |
| | TEIKIN NO. M2101-6 | | | | | | |
| Surface Treatment Bore Clearance Tin Coated MRC: 0.085 mm MP: 1.50 mm | | | | | | | |
| | REFERENCE NO. | | TEIKIN NO. P M2101 | | | | |
| LOW DOME 2.8750"-II 50 - 150 HP 6 cyl. | \emptyset 73.03 +17.1 CD 38.0 TL 83.9 | 2 - 1.59 1 - 1.59 | \emptyset 19.550 TL 61.00 | | | | TEIKIN NO. |
| | TEIKIN NO. M2102-6 | | | | | | |
| Surface Treatment Bore Clearance Tin Coated MRC: 0.085 mm MP: 1.50 mm | | | | | | | |
| | REFERENCE NO. | | TEIKIN NO. P M2101 | | | | |

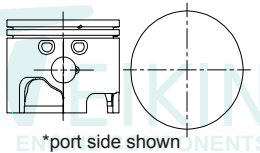
| ENGINE TYPE | PISTON | PISTON RING | PISTON PIN | PIN BUSHING | LINER | | LINER KIT SET |
|---|--|-------------------------|------------------------------------|-------------|---------|-----------|---------------|
| | | | | | FLANGED | NO FLANGE | |
| LOOPER 3.1250" Port / Starboard Side 135 - 175 HP 2.0 Liter V6 6 cyl. | \emptyset 79.38 CD 37.7 TL 71.1 | 1 - 2.36 FK 1 - 1.59 | \emptyset 19.550 TL 66.80 | | | | TEIKIN NO. |
| *port side shown | TEIKIN NO. | | TEIKIN NO. | | | | |
| Surface Treatment: Tin Coated Bore Clearance: MRC: 0.225 mm, MP: 22.50 mm | | | | | | | |
| | | | | | | | 13 |
| LOOPER 3.3750" Port / Starboard Side 150 - 225 HP 2.4 Liter V6 6 cyl. | \emptyset 85.73 CD 37.7 TL 71.1 | 2 - 2.36 FK | \emptyset 19.550 TL 73.80 | | | | TEIKIN NO. |
| *port side shown | TEIKIN NO. | | TEIKIN NO. | | | | |
| Surface Treatment: Tin Coated Bore Clearance: MRC: 0.095 mm, MP: 14.00 mm | | | | | | | |
| | | | | | | | 14 |
| 3.5" 75 - 125 HP 3 cyl. | \emptyset 88.90 CD 37.7 TL 73.7 | 2 - 2.00 HK | \emptyset 19.550 TL 68.60 | | | | TEIKIN NO. |
| *port side shown | TEIKIN NO. | | TEIKIN NO. | | | | |
| Surface Treatment: Tin Coated Bore Clearance: MRC: 0.100 mm, MP: 9.50 mm | | | | | | | |
| | | | | | | | 15 |
| 3.5" 75 - 125 HP 4 cyl. | \emptyset 88.90 CD 37.7 TL 73.7 | 2 - 2.00 HK | \emptyset 19.550 TL 68.60 | | | | TEIKIN NO. |
| *port side shown | TEIKIN NO. | | TEIKIN NO. | | | | |
| Surface Treatment: Tin Coated Bore Clearance: MRC: 0.100 mm, MP: 9.50 mm | | | | | | | |
| | | | | | | | 16 |

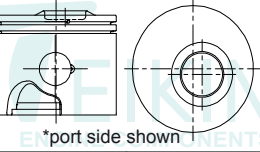







| ENGINE TYPE | PISTON | PISTON RING | PISTON PIN | PIN BUSHING | LINER | | LINER KIT SET |
|--|--|-------------|---|-------------|---------|-----------|---------------|
| | | | | | FLANGED | NO FLANGE | |
| 2.5L Port / Starboard Side 175/200 HP XR6, MAG III V6 6 cyl. | \emptyset 88.90 CD 37.7 TL 69.9 | 2 - 2.00 HK | \emptyset 19.550 TL 73.80  | | | | TEIKIN NO. |
|  *port side shown | TEIKIN NO. M2108P M2108S | | TEIKIN NO. P M2106P | | | | |
| Surface Treatment Bore Clearance Tin Coated MRC: 0.145 mm MP: 20.50 mm | REFERENCE NO. | | | | | | |
| | | | | | | 17 | |
| OPTIMAX 2.5L Port / Starboard Side 115/135/150 HP V6 6 cyl. | \emptyset 88.90 + 3.00 CD 37.7 TL 72.9 | 2 - 2.00 HK | \emptyset 23.310 TL 69.00  | | | | TEIKIN NO. |
|  *port side shown | TEIKIN NO. M2107P M2107S | | TEIKIN NO. P M2107P | | | | |
| Surface Treatment Bore Clearance Tin Coated MRC: 0.200 mm MP: 13.00 mm | REFERENCE NO. | | | | | | |
| | | | | | | 18 | |

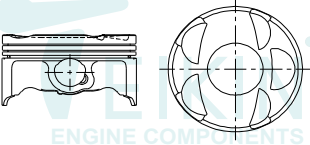

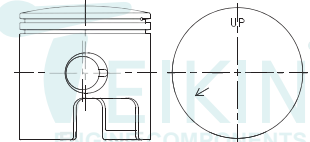



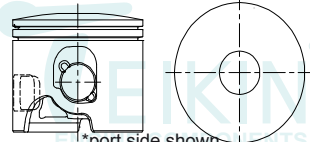

SUITABLE FOR

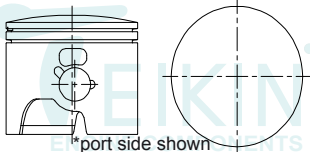
YAMAHA

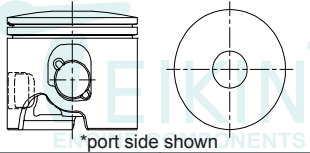
MARINE ENGINE

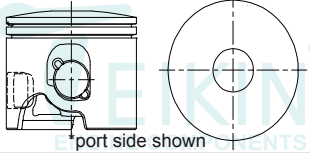

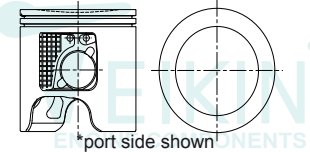





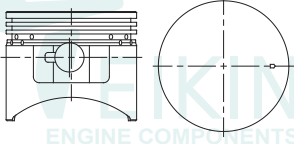

| ENGINE TYPE | PISTON | PISTON RING | PISTON PIN | PIN BUSHING | LINER | | LINER KIT SET |
|---|--|-------------------------------|---|-------------|---------|-----------|---------------|
| | | | | | FLANGED | NO FLANGE | |
| Wave Runner VX 110 Wave Runner VX 110  | \varnothing 76.00 -1.8 CD 22.8 TL 42.8 | 1 - 0.9 1 - 0.8 1 - 1.5 | \varnothing 17.000 TL 51.50  | | | | TEIKIN NO. |
| Surface Treatment Bore Clearance Tin Coated MRC: 0.100 mm MP: 5.80 mm | TEIKIN NO. M1106 | | TEIKIN NO. P M1106 | | | | |
| | REFERENCE NO. | | | | | | |
| | | | | | | | 1 |
| MARINE ENGINE MARINE ENGINE 1 cyl.  | \varnothing 78.00 +3.9 CD 36.1 TL 79.9 | 1 - 2.0 HK 1 - 2.0 | \varnothing 19.900 TL 64.00  | | | | TEIKIN NO. |
| Surface Treatment Bore Clearance Tin Coated MRC: 0.050 mm MP: 25.50 mm | TEIKIN NO. M1101 | | TEIKIN NO. P M1101 | | | | |
| | REFERENCE NO. | | | | | | |
| | | | | | | | 2 |
| 115/225 H.P PORT / STARBOARD SIDE 4 cyl. 1993/2004 V4  | \varnothing 90.00 +4.2 CD 39.9 TL 75.7 | 2 - 2.0 HK | \varnothing 23.070 TL 65.40  | | | | TEIKIN NO. |
| *port side shown Surface Treatment Bore Clearance Tin Coated MRC: 0.100 mm MP: 9.50 mm | TEIKIN NO. M1102P M1102S | | TEIKIN NO. P M1102P | | | | |
| | REFERENCE NO. 64D-11642-02-90 | | | | | | |
| | | | | | | | 3 |
| 115/225 H.P-II PORT / STARBOARD SIDE 4 cyl. 1984/1992 V4  | \varnothing 90.00 +4.2 CD 39.9 TL 75.7 | 2 - 2.0 HK | \varnothing 23.070 TL 65.40  | | | | TEIKIN NO. |
| *port side shown Surface Treatment Bore Clearance Tin Coated MRC: 0.160 mm MP: 22.50 mm | TEIKIN NO. M1103P M1103S | | TEIKIN NO. P M1102P | | | | |
| | REFERENCE NO. 68F-11642-01-85 | | | | | | |
| | | | | | | | 4 |

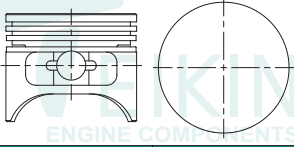
| ENGINE TYPE | PISTON | PISTON RING | PISTON PIN | PIN BUSHING | LINER | | LINER KIT SET |
|---|--|-------------|---|-------------|---------|-----------|---------------|
| | | | | | FLANGED | NO FLANGE | |
| SPECIAL "J" PORT / STARBOARD SIDE 4 cyl. 1984/1992 V4  <small>*port side shown</small> | \varnothing 90.00 +4.5 CD 39.9 TL 76.5 | 2 - 2.0 HK | \varnothing 21.500 TL 76.00  | | | | TEIKIN NO. |
| Surface Treatment Bore Clearance Tin Coated MRC: 0.070 mm MP: 5.00 mm | TEIKIN NO. M1104P M1104S | | TEIKIN NO. P M1104P | | | | |
| REFERENCE NO. 6G7-11642-00-93 | | | | | | | |
| 115/225 H.P PORT / STARBOARD SIDE 6 cyl. 1993/2004 V6  <small>*port side shown</small> | \varnothing 90.00 +4.2 CD 39.9 TL 75.7 | 2 - 2.0 HK | \varnothing 23.070 TL 65.40  | | | | TEIKIN NO. |
| Surface Treatment Bore Clearance Tin Coated MRC: 0.100 mm MP: 9.50 mm | TEIKIN NO. M1102P-6 M1102S-6 | | TEIKIN NO. P M1102P | | | | |
| REFERENCE NO. 64D-11642-02-90 | | | | | | | |
| 115/225 H.P-II PORT / STARBOARD SIDE 6 cyl. 1984/1992 V6  <small>*port side shown</small> | \varnothing 90.00 +4.2 CD 39.9 TL 75.7 | 2 - 2.0 HK | \varnothing 23.070 TL 65.40  | | | | TEIKIN NO. |
| Surface Treatment Bore Clearance Tin Coated MRC: 0.160 mm MP: 22.50 mm | TEIKIN NO. M1103P-6 M1103S-6 | | TEIKIN NO. P M1102P | | | | |
| REFERENCE NO. 68F-11642-01-85 | | | | | | | |
| 225/250 H.P PORT / STARBOARD SIDE 6 cyl. 76° 1994/2001  <small>*port side shown</small> | \varnothing 90.00 -2.0 CD 43.2 TL 87.2 | 2 - 2.0 HK | \varnothing 26.000 TL 67.80  | | | | TEIKIN NO. |
| Surface Treatment Bore Clearance Tin Coated MRC: 0.160 mm MP: 13.50 mm | TEIKIN NO. M1105P M1105S | | TEIKIN NO. P M1105P | | | | |
| REFERENCE NO. | | | | | | | |

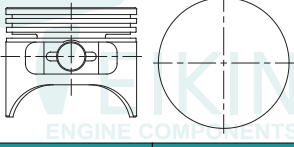
| ENGINE TYPE | PISTON | PISTON RING | PISTON PIN | PIN BUSHING | LINER | | LINER KIT SET |
|--|---|--------------------|--------------------------------------|-------------|---------|-----------|---------------|
| | | | | | FLANGED | NO FLANGE | |
| 95MM 5R 1 cyl. | \varnothing 95.00 -3.3 CD 60.1 TL 110.0 | 3 - 3.0 2 - 6.0 | \varnothing 35.000 TL 80.00 | | | | TEIKIN NO. |
| | TEIKIN NO. | | TEIKIN NO. | | | | |
| | G3101 | | P G1110 | | | | |
| | REFERENCE NO. | | | | | | |
| Surface Treatment None | Bore Clearance MRC: 0.150 mm MP: 29.00 mm | | | | | | 1 |
| 95MM 4R 1 cyl. | \varnothing 95.00 -2.9 CD 60.1 TL 110.4 | 3 - 3.0 1 - 6.0 | \varnothing 35.000 TL 80.00 | | | | TEIKIN NO. |
| | TEIKIN NO. | | TEIKIN NO. | | | | |
| | G3105 | | P G1110 | | | | |
| | REFERENCE NO. | | | | | | |
| Surface Treatment None | Bore Clearance MRC: 0.150 mm MP: 16.35 mm | | | | | | 2 |
| 1100 MM 1 cyl. | \varnothing 100.00 -2.4 CD 60.2 TL 102.0 | 3 - 2.5 1 - 5.0 | \varnothing 35.000 TL 80.00 | | | | TEIKIN NO. |
| | TEIKIN NO. | | TEIKIN NO. | | | | |
| | G3104 | | P G1110 | | | | |
| | REFERENCE NO. | | | | | | |
| Surface Treatment None | Bore Clearance MRC: 0.150 mm MP: 18.30 mm | | | | | | 3 |
| 1110 MM 1 cyl. | \varnothing 109.80 -20.7 CD 65.1 TL 109.9 | 3 - 2.5 1 - 5.0 | \varnothing 36.000 TL 94.50 | | | | TEIKIN NO. |
| | TEIKIN NO. | | TEIKIN NO. | | | | |
| | G3106 | | P44244 | | | | |
| | REFERENCE NO. | | | | | | |
| Surface Treatment Tin Coated | Bore Clearance MRC: 0.020 mm MP: 20.00 mm | | | | | | 4 |

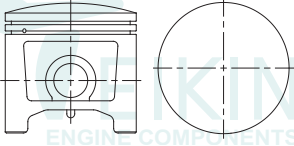
0

| ENGINE TYPE | PISTON | PISTON RING | PISTON PIN | PIN BUSHING | LINER | | LINER KIT SET |
|---|--|------------------------|---|-------------|---------|-----------|---------------|
| | | | | | FLANGED | NO FLANGE | |
| G-200 200 cc 1 cyl.  | \varnothing 67.00 CD 23.5 TL 56.0 | 2 - 2.0 1 - 3.0 | \varnothing 15.000 TL 53.50  | | | | TEIKIN NO. |
| | TEIKIN NO. | | TEIKIN NO. | | | | |
| | G4101 | | P G4101 | | | | |
| | REFERENCE NO. | | | | | | |
| Surface Treatment Bore Clearance None MRC: - mm MP: - mm | | | | | | | 5 |
| EY-15 1 cyl.  | \varnothing 63.00 CD 24.8 TL 52.0 | 2 - 2.0 1 - 2.8 | \varnothing 14.000 TL 52.00  | | | | TEIKIN NO. |
| | TEIKIN NO. | | TEIKIN NO. | | | | |
| | G5101 | | P G5101 | | | | |
| | REFERENCE NO. | | | | | | |
| Surface Treatment Bore Clearance None MRC: - mm MP: - mm | | | | | | | 6 |
| EY-20 1 cyl.  | \varnothing 67.00 CD 20.0 TL 56.0 | 2 - 2.0 1 - 3.0 | \varnothing 14.000 TL 52.00  | | | | TEIKIN NO. |
| | TEIKIN NO. | | TEIKIN NO. | | | | |
| | G5102 | | P G5101 | | | | |
| | REFERENCE NO. | | | | | | |
| Surface Treatment Bore Clearance None MRC: - mm MP: - mm | | | | | | | 7 |
| 58MM 2R 1 cyl. STIHL  | \varnothing 58.00 CD 31.1 TL 57.9 | 2 - 1.5 +3.8 | \varnothing 15.000 TL 42.00  | | | | TEIKIN NO. |
| | TEIKIN NO. | | TEIKIN NO. | | | | |
| | G6101 | | P G6101 | | | | |
| | REFERENCE NO. | | | | | | |
| Surface Treatment Bore Clearance None MRC: 0.030 mm MP: 12.50 mm | | | | | | | 8 |



NUMERICAL INDEX



NUMERICAL INDEX

| TEIKIN NO | ENGINE MODEL | | Cyl. | BORE Ø (mm) | PAGE | BOX NO. |
|-----------|---------------|----------------|------|-------------|------|---------|
| 28101 | BED FORD | 330, J6, 103 | 6 | 103.18 | 05 | 1 |
| 28107 | BED FORD | 107 | 6 | 107.21 | 05 | 4 |
| 28108 | BED FORD | 104 | 6 | 104.78 | 05 | 3 |
| 28109 | BED FORD | 103-II | 6 | 103.18 | 05 | 2 |
| 29106 | MERCEDES BENZ | OM - 355 | 6 | 128.00 | 148 | 12 |
| 29110 | MERCEDES BENZ | 911, OM - 352 | 6 | 97.00 | 148 | 11 |
| 29116 | MERCEDES BENZ | M115.952 / 955 | 4 | 93.75 | 145 | 4 |
| 29117 | MERCEDES BENZ | M115.951 / 954 | 4 | 93.75 | 145 | 3 |
| 29118 | MERCEDES BENZ | 240D | 4 | 90.90 | 147 | 10 |
| 29119 | MERCEDES BENZ | M102.945 | 4 | 95.50 | 146 | 5 |
| 29120 | MERCEDES BENZ | M115.923 | 4 | 87.00 | 145 | 1 |
| 29121 | MERCEDES BENZ | M102.980 | 4 | 95.50 | 146 | 6 |
| 29601 | MERCEDES BENZ | M102 E20/V20 | 4 | 89.00 | 145 | 2 |
| 29602A | MERCEDES BENZ | OM 661 | 4 | 89.00 | 147 | 8 |
| 29603A | MERCEDES BENZ | OM 601 | 4 | 87.00 | 147 | 7 |
| 29604AG | MERCEDES BENZ | OM 602 TURBO | 5 | 89.00 | 147 | 9 |
| 30104 | CHEVROLET | AVEO | 4 | 76.50 | 08 | 4 |
| 30105 | CHEVROLET | AVEO-II | 4 | 79.00 | 09 | 6 |
| 30106 | CHEVROLET | OPTRA 1.8L | 4 | 81.60 | 09 | 8 |
| 30107 | CHEVROLET | AVEO-III | 4 | 77.90 | 09 | 5 |
| 30109 | CHEVROLET | SPARK GT 1.2 | 4 | 69.70 | 08 | 1 |
| 30110 | CHEVROLET | SAIL 1.4 L | 4 | 73.80 | 08 | 2 |
| 30111 | CHEVROLET | CAPTIVA 2.4L | 4 | 87.50 | 10 | 9 |
| 30112 | CHEVROLET | CRUZE 1.8L | 4 | 80.50 | 09 | 7 |
| 30113 | CHEVROLET | CAPTIVA 3.2 | 6 | 89.00 | 10 | 10 |
| 30114 | CHEVROLET | SPIN 1.5 | 4 | 74.71 | 08 | 3 |
| 31115 | CHRYSLER | 2.5 L | 4 | 87.50 | 11 | 3 |
| 31116 | CHRYSLER | 2.4 L | 4 | 87.50 | 11 | 2 |
| 31117 | CHRYSLER | 2.7 L | 6 | 86.00 | 11 | 1 |
| 31118 | CHRYSLER | EDZ | 4 | 87.50 | 11 | 4 |
| 31119 | CHRYSLER | MOT. 232 | 6 | 96.00 | 13 | 10 |
| 31120 | CHRYSLER | MOT. 201 | 6 | 93.00 | 12 | 5 |
| 31121 | CHRYSLER | EGH | 6 | 96.00 | 12 | 8 |
| 31122 | CHRYSLER | EGJ | 6 | 96.00 | 13 | 9 |
| 31124 | CHRYSLER | 153 | 4 | 98.43 | 13 | 11 |
| 31129 | CHRYSLER | 370 CID | 8 | 103.00 | 14 | 13 |
| 31130-6 | CHRYSLER | POWER TECH 3.7 | 6 | 93.00 | 12 | 6 |

NUMERICAL INDEX

| TEIKIN NO | ENGINE MODEL | | Cyl. | BORE Ø (mm) | PAGE | BOX NO. |
|-----------|--------------|-----------------------|------|-------------|------|---------|
| 31130 | CHRYSLER | POWER TECH 4.7 | 8 | 93.00 | 12 | 7 |
| 31131 | CHRYSLER | HEMI 5.7 | 8 | 99.50 | 13 | 12 |
| 32102 | DAIHATSU | DG | 4 | 88.00 | 21 | 18 |
| 32103 | DAIHATSU | DG OLD-4R | 4 | 88.00 | 21 | 19 |
| 32106 | DAIHATSU | S-38P (NEW) | 2 | 62.00 | 17 | 1 |
| 32110 | DAIHATSU | S-10P | 2 | 71.60 | 18 | 5 |
| 32117 | DAIHATSU | G11 | 3 | 76.00 | 19 | 11 |
| 32120 | DAIHATSU | CL | 3 | 76.00 | 21 | 16 |
| 32124 | DAIHATSU | S75 | 3 | 76.00 | 19 | 12 |
| 32125 | DAIHATSU | S89 | 4 | 76.00 | 20 | 14 |
| 32126 | DAIHATSU | DL | 4 | 92.00 | 22 | 21 |
| 32127 | DAIHATSU | DL NEW-28 | 4 | 92.00 | 22 | 23 |
| 32128 | DAIHATSU | DL NEW-26 | 4 | 92.00 | 22 | 22 |
| 32139 | DAIHATSU | DV26 5R | 4 | 88.00 | 22 | 20 |
| 32142 | DAIHATSU | HD | 4 | 76.00 | 20 | 13 |
| 32144 | DAIHATSU | K3-DE | 4 | 72.00 | 19 | 9 |
| 32145 | DAIHATSU | S89-II | 4 | 76.00 | 20 | 15 |
| 32146 | DAIHATSU | KANCIL 850 CC NEW | 3 | 66.60 | 17 | 2 |
| 32147 | DAIHATSU | KELISA 1000 CC | 3 | 72.00 | 18 | 8 |
| 32150 | DAIHATSU | EF | 3 | 68.00 | 17 | 3 |
| 32151 | DAIHATSU | EJ-VE-II | 3 | 72.00 | 18 | 7 |
| 32601 | DAIHATSU | CD | 3 | 70.00 | 17 | 4 |
| 32602 | DAIHATSU | CL-T | 3 | 76.00 | 21 | 17 |
| 32605 | DAIHATSU | EJ-DE / EJ-VE | 3 | 72.00 | 18 | 6 |
| 32606 | DAIHATSU | K3-VE-II | 4 | 72.00 | 19 | 10 |
| 33101 | CHERRY | TIGGO | 4 | 81.00 | 07 | 1 |
| 34101 | FIAT | 103H, 105, 103 | 4 | 67.80 | 24 | 1 |
| 34102 | FIAT | 103G, 1100D | 4 | 71.85 | 26 | 10 |
| 34103 | FIAT | 125, 125A | 4 | 80.00 | 27 | 14 |
| 34109 | FIAT | 1300 | 4 | 72.00 | 26 | 11 |
| 34113 | FIAT | 124S | 4 | 80.00 | 27 | 13 |
| 34118 | FIAT | TRACTOR 300, 350, 355 | 4 | 100.00 | 29 | 19 |
| 34119 | FIAT | 160 A3.000 | 4 | 70.00 | 24 | 2 |
| 34120 | FIAT | 160 A1.00 | 4 | 80.50 | 27 | 15 |
| 34121 | FIAT | UNO 1100 | 4 | 70.00 | 25 | 6 |
| 34122 | FIAT | FIRE 16V | 4 | 70.00 | 24 | 3 |
| 34123 | FIAT | FIRE 8V | 4 | 70.00 | 24 | 4 |



NUMERICAL INDEX

| TEIKIN NO | ENGINE MODEL | | Cyl. | BORE Ø (mm) | PAGE | BOX NO. |
|-----------|--------------|-------------------------|------|-------------|------|---------|
| 34124 | FIAT | FIRE FLEX 8V | 4 | 70.00 | 25 | 5 |
| 34125 | FIAT | FIRE 1.3L 8V | 4 | 70.80 | 25 | 8 |
| 34126 | FIAT | FIRE 1.3L 16V | 4 | 70.80 | 25 | 7 |
| 34127 | FIAT | FIRE FLEX 1.3L 8V | 4 | 70.80 | 26 | 9 |
| 34128 | FIAT | FIRE FLEX 1.4L 8V | 4 | 72.00 | 26 | 12 |
| 34129A | FIAT | PALIO 1.3L JTD | 4 | 69.60 | 29 | 18 |
| 34130 | FIAT | SHAHEN | 4 | 80.50 | 27 | 16 |
| 34131 | FIAT | TEMPRA 1600 TWO | 4 | 86.40 | 28 | 17 |
| 35101 | FORD | THAMES TRADER | 6 | 100.00 | 35 | 23 |
| 35102 | FORD | 2402 E | 6 | 93.65 | 35 | 21 |
| 35165 | FORD | 751M, BG2C | 4 | 80.99 | 31 | 5 |
| 35166 | FORD | V6ESSEX | 6 | 93.65 | 34 | 17 |
| 35167 | FORD | V6ESSEX | 6 | 93.65 | 34 | 18 |
| 35168-4 | FORD | V4 | 4 | 93.65 | 33 | 15 |
| 35168 | FORD | V6 | 6 | 93.65 | 33 | 16 |
| 35169 | FORD | P-764 | 4 | 89.32 | 32 | 12 |
| 35170 | FORD | CVH-LUC | 4 | 79.96 | 30 | 4 |
| 35171 | FORD | CVH, FUA, F6B, FU | 4 | 77.25 | 30 | 2 |
| 35172 | FORD | KOLN 2V (T88) | 4 | 90.83 | 33 | 14 |
| 35173 | FORD | CVH, JPA, JPC | 4 | 79.96 | 30 | 3 |
| 35174 | FORD | 281 | 8 | 90.20 | 33 | 13 |
| 35177 | FORD | ZETEC | 4 | 84.80 | 32 | 9 |
| 35178 | FORD | MOT. 1.9 Lt | 4 | 82.00 | 31 | 6 |
| 35179 | FORD | VIN 3 ZETEC | 4 | 84.80 | 31 | 8 |
| 35180 | FORD | 2.0 L | 4 | 84.80 | 31 | 7 |
| 35181 | FORD | AODA/B,CJBA/B,N4JB | 4 | 87.50 | 32 | 11 |
| 35182 | FORD | 238 | 6 | 96.80 | 34 | 20 |
| 35183 | FORD | 140 | 4 | 96.00 | 34 | 19 |
| 35191 | FORD | CVH 2.0 | 4 | 84.86 | 32 | 10 |
| 35600 | FORD | JLB | 4 | 74.00 | 30 | 1 |
| 35601A | FORD | 4A B/ BA / BB / CA / FA | 4 | 93.67 | 35 | 22 |
| 36101 | HINO | DM-100 | 6 | 90.00 | 39 | 1 |
| 36111 | HINO | EH-100 | 6 | 105.00 | 41 | 9 |
| 36112 | HINO | ED-100 | 6 | 128.00 | 45 | 28 |
| 36113 | HINO | EH-700 | 6 | 110.00 | 42 | 15 |
| 36124 | HINO | H07C NEW | 6 | 110.00 | 42 | 16 |
| 36125 | HINO | H07C OLD | 6 | 110.00 | 43 | 17 |
| 36127 | HINO | H07D | 6 | 110.00 | 43 | 20 |

NUMERICAL INDEX

| TEIKIN NO | ENGINE MODEL | | Cyl. | BORE Ø (mm) | PAGE | BOX NO. |
|-----------|--------------|----------------|------|-------------|------|---------|
| 36128 | HINO | EM 100 | 6 | 124.00 | 45 | 27 |
| 36129AG | HINO | H07C-T | 6 | 110.00 | 43 | 18 |
| 36133A | HINO | H06CTV/CTL-II | 6 | 108.00 | 42 | 13 |
| 36135A | HINO | H06CTE | 6 | 108.00 | 41 | 12 |
| 36136A | HINO | H06CTB | 6 | 108.00 | 41 | 11 |
| 36137AG | HINO | H06CTV/CTL-III | 6 | 108.00 | 42 | 14 |
| 36601 | HINO | EB300 | 6 | 120.00 | 45 | 26 |
| 36603 | HINO | EC100 | 6 | 97.00 | 39 | 2 |
| 36650A | HINO | EK100 | 6 | 137.00 | 46 | 29 |
| 36651A | HINO | W06D | 6 | 104.00 | 40 | 6 |
| 36652A | HINO | H06BT | 6 | 105.80 | 41 | 10 |
| 36653 | HINO | W04D | 4 | 104.00 | 39 | 4 |
| 36654A | HINO | EF750 | 8 | 137.00 | 46 | 30 |
| 36655AG | HINO | H07C-T-II | 6 | 110.00 | 43 | 19 |
| 36656A | HINO | W06E | 6 | 104.00 | 40 | 8 |
| 36657A | HINO | J05C | 4 | 114.00 | 44 | 21 |
| 36657-6 | HINO | J08C | 6 | 114.00 | 44 | 24 |
| 36658 | HINO | W04D LATE | 4 | 104.00 | 40 | 5 |
| 36659AG-4 | HINO | J05C-T | 4 | 114.00 | 44 | 22 |
| 36659AG-5 | HINO | J07C-T | 5 | 114.00 | 44 | 23 |
| 36659AG | HINO | J08C-T | 6 | 114.00 | 45 | 25 |
| 36660A | HINO | W04CT | 4 | 104.00 | 39 | 3 |
| 36661A | HINO | W06DT | 6 | 104.00 | 40 | 7 |
| 37116 | HOLDEN | 202 | 6 | 92.08 | 47 | 1 |
| 38109 | HONDA | EN | 4 | 72.00 | 48 | 2 |
| 38112 | HONDA | ED1 | 4 | 74.00 | 49 | 7 |
| 38114 | HONDA | EK-1 | 4 | 77.00 | 54 | 28 |
| 38129 | HONDA | BS / A20A1 | 4 | 82.70 | 58 | 43 |
| 38145 | HONDA | D15B2 / D15B1 | 4 | 75.00 | 51 | 15 |
| 38146 | HONDA | D16A6, ZC | 4 | 75.00 | 52 | 20 |
| 38147 | HONDA | EJ | 4 | 72.00 | 48 | 1 |
| 38148 | HONDA | B21A1 | 4 | 83.00 | 58 | 44 |
| 38149 | HONDA | D16Z6 | 4 | 75.00 | 54 | 25 |
| 38150 | HONDA | F18A | 4 | 85.00 | 59 | 47 |
| 38151 | HONDA | B18C1 | 4 | 81.00 | 57 | 37 |
| 38152 | HONDA | B18B1 | 4 | 81.00 | 56 | 36 |
| 38153 | HONDA | D16Y8 | 4 | 75.00 | 53 | 24 |
| 38154 | HONDA | B20B4 | 4 | 84.00 | 59 | 45 |



NUMERICAL INDEX

| TEIKIN NO | ENGINE MODEL | Cyl. | BORE Ø (mm) | PAGE | BOX NO. |
|-----------|----------------|------|-------------|------|---------|
| 38155 | HONDA B16A2 | 4 | 81.00 | 56 | 34 |
| 38156 | HONDA H22A1 | 4 | 87.00 | 62 | 57 |
| 38157 | HONDA H22A4 | 4 | 87.00 | 62 | 58 |
| 38158 | HONDA H23A1 | 4 | 87.00 | 62 | 59 |
| 38159 | HONDA D15Z1 | 4 | 75.00 | 52 | 18 |
| 38166 | HONDA EF1 | 4 | 74.00 | 49 | 8 |
| 38168 | HONDA C27A4 | 6 | 87.00 | 64 | 67 |
| 38169 | HONDA D17A2 | 4 | 75.00 | 54 | 27 |
| 38170 | HONDA D17A1 | 4 | 75.00 | 54 | 26 |
| 38171 | HONDA B20Z2 | 4 | 84.00 | 59 | 46 |
| 38172 | HONDA F23A5 | 4 | 86.00 | 60 | 50 |
| 38173 | HONDA D16A6-II | 4 | 75.00 | 53 | 21 |
| 38174 | HONDA K24A1 | 4 | 87.00 | 63 | 61 |
| 38175 | HONDA K24A4 | 4 | 87.00 | 63 | 63 |
| 38176 | HONDA J35A1 | 6 | 89.00 | 65 | 69 |
| 38177 | HONDA J35A3 | 6 | 89.00 | 65 | 70 |
| 38178 | HONDA J30A4 | 6 | 86.00 | 61 | 55 |
| 38179 | HONDA EK-1-III | 4 | 77.00 | 55 | 29 |
| 38180 | HONDA F23A1 | 4 | 86.00 | 60 | 49 |
| 38181 | HONDA D16Y7 | 4 | 75.00 | 53 | 23 |
| 38182 | HONDA L15A | 4 | 73.00 | 49 | 5 |
| 38183 | HONDA JAZZ RS | 4 | 73.00 | 48 | 3 |
| 38184 | HONDA K24A4-II | 4 | 87.00 | 63 | 64 |
| 38185 | HONDA K20A3 | 4 | 86.00 | 60 | 52 |
| 38186 | HONDA R20A | 4 | 81.00 | 58 | 41 |
| 38187 | HONDA D15B-II | 4 | 75.00 | 51 | 16 |
| 38188 | HONDA K24Z3 | 4 | 87.00 | 64 | 66 |
| 38189 | HONDA K24A2 | 4 | 87.00 | 63 | 62 |
| 38190 | HONDA K20A2 | 4 | 86.00 | 60 | 51 |
| 38191 | HONDA K24Z2 | 4 | 87.00 | 64 | 65 |
| 38192 | HONDA J35A7 | 6 | 89.00 | 65 | 71 |
| 38193 | HONDA J32A3 | 6 | 89.00 | 64 | 68 |
| 38194 | HONDA J35A8 | 6 | 89.00 | 65 | 72 |
| 38195 | HONDA J30A | 6 | 86.00 | 61 | 54 |
| 38196 | HONDA J35Z3 | 6 | 89.00 | 66 | 73 |
| 38197 | HONDA ACCORD | 4 | 87.00 | 61 | 56 |
| 38198 | HONDA K24A | 4 | 87.00 | 62 | 60 |
| 38199 | HONDA K20A5 | 4 | 86.00 | 61 | 53 |
| 38600 | HONDA EV | 4 | 74.00 | 50 | 10 |
| 38602 | HONDA ES | 4 | 80.00 | 55 | 31 |



NUMERICAL INDEX

| TEIKIN NO | ENGINE MODEL | | Cyl. | BORE Ø (mm) | PAGE | BOX NO. |
|-----------|--------------|------------------|------|-------------|------|---------|
| 38603 | HONDA | EW | 4 | 74.00 | 50 | 11 |
| 38604 | HONDA | ES-II | 4 | 80.00 | 56 | 33 |
| 38605 | HONDA | EW-II | 4 | 74.00 | 50 | 12 |
| 38606 | HONDA | D16A | 4 | 75.00 | 52 | 19 |
| 38650 | HONDA | EM1 | 4 | 74.00 | 50 | 9 |
| 38651 | HONDA | F22A | 4 | 85.00 | 59 | 48 |
| 38652 | HONDA | EP | 4 | 77.00 | 55 | 30 |
| 38654 | HONDA | A20A BS-II | 4 | 82.70 | 58 | 42 |
| 38655 | HONDA | ES1 | 4 | 80.00 | 55 | 32 |
| 38656 | HONDA | D15 | 4 | 75.00 | 51 | 14 |
| 38657 | HONDA | L13A4 | 4 | 73.00 | 48 | 4 |
| 38658A | HONDA | 20T2N/20T2 TURBO | 4 | 84.45 | 67 | 75 |
| 38659 | HONDA | R18A1/A2 | 4 | 81.00 | 57 | 40 |
| 38660 | HONDA | B20A5 | 4 | 81.00 | 57 | 39 |
| 38661AG | HONDA | N22A1/N22A2 | 4 | 85.00 | 67 | 76 |
| 38662 | HONDA | C32A | 6 | 90.00 | 66 | 74 |
| 38663 | HONDA | D15A3 EW4 | 4 | 74.00 | 49 | 6 |
| 38664 | HONDA | B20A3 | 4 | 81.00 | 57 | 38 |
| 38665 | HONDA | D16A-II | 4 | 75.00 | 53 | 22 |
| 38666 | HONDA | D13 | 4 | 75.00 | 51 | 13 |
| 38667 | HONDA | D15-II | 4 | 75.00 | 52 | 17 |
| 38668 | HONDA | B18A1 | 4 | 81.00 | 56 | 35 |
| 39104 | ISUZU | G161Z | 4 | 82.00 | 81 | 8 |
| 39110 | ISUZU | G180Z | 4 | 84.00 | 82 | 12 |
| 39119 | ISUZU | G200Z | 4 | 87.00 | 84 | 18 |
| 39125 | ISUZU | C-240 OLD | 4 | 86.00 | 90 | 40 |
| 39127 | ISUZU | C-190 | 4 | 86.00 | 89 | 37 |
| 39128 | ISUZU | C-190-3R | 4 | 86.00 | 90 | 38 |
| 39130 | ISUZU | C-223 | 4 | 88.00 | 91 | 42 |
| 39137-4 | ISUZU | DA220 | 4 | 100.00 | 96 | 63 |
| 39137 | ISUZU | DA-120-4R | 6 | 100.00 | 96 | 64 |
| 39138 | ISUZU | DA-120-5R | 6 | 100.00 | 96 | 65 |
| 39142 | ISUZU | DA-640 | 6 | 102.00 | 100 | 81 |
| 39148-4 | ISUZU | 4BB1 | 4 | 102.00 | 97 | 66 |
| 39148 | ISUZU | 6BB1 | 6 | 102.00 | 99 | 76 |
| 39149-4 | ISUZU | 4BD1 | 4 | 102.00 | 97 | 69 |
| 39149 | ISUZU | 6BD1 | 6 | 102.00 | 99 | 77 |
| 39151A-4 | ISUZU | 4BD1-II | 4 | 102.00 | 98 | 71 |
| 39151 | ISUZU | 6BD1-II | 6 | 102.00 | 100 | 78 |

NUMERICAL INDEX

| TEIKIN NO | ENGINE MODEL | Cyl. | BORE Ø (mm) | PAGE | BOX NO. |
|-----------|-------------------|------|-------------|------|---------|
| 39157 | ISUZU 4FC1 | 4 | 84.00 | 89 | 36 |
| 39159 | ISUZU 4FD1 | 4 | 88.00 | 90 | 41 |
| 39160 | ISUZU 4BA1 | 4 | 98.00 | 96 | 62 |
| 39162 | ISUZU 4JA1 | 4 | 93.00 | 92 | 47 |
| 39163 | ISUZU 4JB1 | 4 | 93.00 | 93 | 50 |
| 39165 | ISUZU 4BC1 | 4 | 102.00 | 97 | 67 |
| 39166 | ISUZU 4BC2 | 4 | 102.00 | 97 | 68 |
| 39170 | ISUZU 4EC1 OLD | 4 | 76.00 | 88 | 30 |
| 39175 | ISUZU 4ZC1 | 4 | 88.00 | 85 | 21 |
| 39176 | ISUZU 4ZD1 | 4 | 89.30 | 85 | 22 |
| 39179 | ISUZU 4EC1 TURBO | 4 | 76.00 | 88 | 31 |
| 39180 | ISUZU 4BE1 | 4 | 105.00 | 101 | 82 |
| 39181 | ISUZU 4HF1 | 4 | 112.00 | 103 | 91 |
| 39182 | ISUZU 6BG1 | 6 | 105.00 | 101 | 85 |
| 39183 | ISUZU 4FB1 | 4 | 84.00 | 89 | 35 |
| 39184 | ISUZU 4BD1-III | 4 | 102.00 | 98 | 72 |
| 39184-6 | ISUZU 6BD1-III | 6 | 102.00 | 100 | 79 |
| 39185 | ISUZU 4ZE1 | 4 | 92.60 | 85 | 24 |
| 39186 | ISUZU 6VD1 | 6 | 93.40 | 86 | 26 |
| 39187 | ISUZU 4HF1-II | 4 | 112.00 | 103 | 93 |
| 39188 | ISUZU 4JB1-T | 4 | 93.00 | 93 | 52 |
| 39189 | ISUZU 4EE1-T | 4 | 79.00 | 88 | 33 |
| 39190 | ISUZU 4JB1-T LATE | 4 | 93.00 | 93 | 53 |
| 39208 | ISUZU G180SR | 4 | 84.00 | 82 | 11 |
| 39209 | ISUZU 4XE1W | 4 | 80.00 | 81 | 6 |
| 39210 | ISUZU 4XE1V | 4 | 80.00 | 81 | 5 |
| 39211 | ISUZU X22SE | 4 | 86.00 | 83 | 16 |
| 39218 | ISUZU C-223-II | 4 | 88.00 | 91 | 44 |
| 39226 | ISUZU G200Z-II | 4 | 87.00 | 84 | 19 |
| 39227A | ISUZU 4BD1 LATE | 4 | 102.00 | 98 | 70 |
| 39228 | ISUZU 4ZD1-II | 4 | 89.30 | 85 | 23 |
| 39229 | ISUZU X20SE | 4 | 86.00 | 83 | 15 |
| 39230 | ISUZU X22SE-II | 4 | 86.00 | 84 | 17 |
| 39231 | ISUZU 4JA1T NEW | 4 | 93.00 | 92 | 49 |
| 39232AG | ISUZU 4JH1-TC | 4 | 95.40 | 95 | 58 |
| 39233 | ISUZU LUV | 4 | 86.00 | 83 | 14 |
| 39234 | ISUZU 6VE1 | 6 | 93.40 | 86 | 27 |
| 39235 | ISUZU DIMAX 2.4L | 4 | 87.50 | 84 | 20 |
| 39236 | ISUZU G161ZB-II | 4 | 82.00 | 82 | 9 |
| 39237 | ISUZU 6VE1-III | 6 | 93.40 | 87 | 29 |

NUMERICAL INDEX

| TEIKIN NO | ENGINE MODEL | Cyl. | BORE Ø (mm) | PAGE | BOX NO. |
|-----------|-------------------|------|-------------|------|---------|
| 39600 | ISUZU 4JG2 EARLY | 4 | 95.40 | 94 | 54 |
| 39601 | ISUZU C-223 OLD | 4 | 88.00 | 91 | 43 |
| 39602 | ISUZU 4FG1 | 4 | 89.30 | 92 | 46 |
| 39603 | ISUZU 4XC1 | 4 | 77.00 | 80 | 1 |
| 39604 | ISUZU 4ZE1-II | 4 | 92.60 | 86 | 25 |
| 39605 | ISUZU 4ZA1 | 4 | 82.00 | 81 | 7 |
| 39606 | ISUZU 6SA1 | 6 | 115.00 | 105 | 101 |
| 39607 | ISUZU 6HE1 | 6 | 110.00 | 102 | 89 |
| 39608AG | ISUZU 4JG2-T | 4 | 95.40 | 94 | 55 |
| 39609 | ISUZU C-223-T | 4 | 88.00 | 91 | 45 |
| 39611AG | ISUZU 4BD2-T | 4 | 102.00 | 99 | 74 |
| 39612 | ISUZU 4BE1-II | 4 | 105.00 | 101 | 83 |
| 39614 | ISUZU 6BG1-T | 6 | 105.00 | 102 | 86 |
| 39615AG | ISUZU 6SA1-T | 6 | 115.00 | 106 | 102 |
| 39616 | ISUZU 6BF1 | 6 | 105.00 | 101 | 84 |
| 39617 | ISUZU DH100 | 6 | 120.00 | 107 | 107 |
| 39618 | ISUZU 4BD1-T | 4 | 102.00 | 98 | 73 |
| 39620 | ISUZU C-221-II | 4 | 83.00 | 89 | 34 |
| 39621 | ISUZU C-240 | 4 | 86.00 | 90 | 39 |
| 39623 | ISUZU 6SD1 | 6 | 120.00 | 107 | 106 |
| 39624 | ISUZU 6RB1 | 6 | 135.00 | 107 | 109 |
| 39625 | ISUZU 10PC1 | 10 | 119.00 | 106 | 104 |
| 39626 | ISUZU 10PD1 | 10 | 119.00 | 106 | 105 |
| 39628 | ISUZU G161Z-II | 4 | 82.00 | 82 | 10 |
| 39650 | ISUZU 4XC1-II | 4 | 77.00 | 80 | 2 |
| 39651A | ISUZU 6HH1 | 6 | 115.00 | 105 | 98 |
| 39652 | ISUZU 4XC1-III | 4 | 77.00 | 80 | 3 |
| 39653 | ISUZU 4HG1 | 4 | 115.00 | 104 | 94 |
| 39654 | ISUZU G180Z-II | 4 | 84.00 | 83 | 13 |
| 39655AG | ISUZU 4BD2-T LATE | 4 | 102.00 | 99 | 75 |
| 39656A | ISUZU 4JB1 LATE | 4 | 93.00 | 93 | 51 |
| 39657A | ISUZU 6QA1 | 6 | 125.00 | 107 | 108 |
| 39658A | ISUZU 4JA1 LATE | 4 | 93.00 | 92 | 48 |
| 39659 | ISUZU 4XC1-IV | 4 | 77.00 | 80 | 4 |
| 39660AG | ISUZU 4JG2-T NEW | 4 | 95.40 | 94 | 56 |
| 39661AG | ISUZU 4JX1 | 4 | 95.40 | 95 | 61 |
| 39662A | ISUZU PA1 | 10 | 115.00 | 106 | 103 |
| 39663AG | ISUZU 6HE1-T | 6 | 110.00 | 103 | 90 |
| 39664AG | ISUZU 4HE1-TC | 4 | 110.00 | 102 | 88 |
| 39665AG | ISUZU 6HK1-TC | 6 | 115.00 | 105 | 99 |



NUMERICAL INDEX

| TEIKIN NO | ENGINE MODEL | | Cyl. | BORE Ø (mm) | PAGE | BOX NO. |
|-----------|--------------|---------------|------|-------------|------|---------|
| 39666AG | ISUZU | 4HE1-T | 4 | 110.00 | 102 | 87 |
| 39667A | ISUZU | 6BD1-T | 6 | 102.00 | 100 | 80 |
| 39668A | ISUZU | 4EE1 | 4 | 79.00 | 88 | 32 |
| 39669AG | ISUZU | 4JG2-T-II | 4 | 95.40 | 94 | 57 |
| 39670AG | ISUZU | 4HL1 | 4 | 115.00 | 104 | 96 |
| 39671AG | ISUZU | 4HK1-TC-II | 4 | 115.00 | 104 | 97 |
| 39672A | ISUZU | 4HF1 NEW | 4 | 112.00 | 103 | 92 |
| 39673 | ISUZU | 6VE1-II | 6 | 93.40 | 86 | 28 |
| 39674AG | ISUZU | 4JJ1-TC CRDI | 4 | 95.40 | 95 | 59 |
| 39675AG | ISUZU | 4JK1-TC | 4 | 95.40 | 95 | 60 |
| 39676AG | ISUZU | 4HG1-T | 4 | 115.00 | 104 | 95 |
| 39677AG | ISUZU | 6HL1-TC | 6 | 115.00 | 105 | 100 |
| 40103 | LANDROVER | 3.562 | 4 | 90.49 | 117 | 1 |
| 41601 | PROTON | GEN 2 | 4 | 76.00 | 239 | 1 |
| 41602 | PROTON | SAGA | 4 | 76.00 | 239 | 2 |
| 42107 | MAZDA | SL | 4 | 100.00 | 143 | 90 |
| 42108 | MAZDA | PB | 4 | 68.00 | 120 | 1 |
| 42127 | MAZDA | B3 | 4 | 71.00 | 120 | 3 |
| 42131 | MAZDA | E3 | 4 | 77.00 | 122 | 10 |
| 42132 | MAZDA | E5 NEW | 4 | 77.00 | 122 | 12 |
| 42140 | MAZDA | NA NEW | 4 | 78.00 | 125 | 21 |
| 42141 | MAZDA | NA OLD | 4 | 78.00 | 125 | 23 |
| 42142 | MAZDA | NA NEW - II | 4 | 78.00 | 125 | 22 |
| 42146 | MAZDA | MA | 4 | 80.00 | 127 | 29 |
| 42149 | MAZDA | HA | 4 | 95.00 | 142 | 86 |
| 42150 | MAZDA | XB | 4 | 92.00 | 140 | 79 |
| 42150 | MAZDA | ZB OLD | 6 | 92.00 | 140 | 81 |
| 42152 | MAZDA | VC OLD | 4 | 80.00 | 127 | 32 |
| 42157 | MAZDA | FE | 4 | 86.00 | 132 | 49 |
| 42159 | MAZDA | F6 | 4 | 81.00 | 128 | 33 |
| 42163 | MAZDA | G6 | 4 | 92.00 | 136 | 65 |
| 42164 | MAZDA | F2 | 4 | 86.00 | 131 | 45 |
| 42165 | MAZDA | BP05 | 4 | 83.00 | 129 | 37 |
| 42166 | MAZDA | FS | 4 | 83.00 | 130 | 41 |
| 42167 | MAZDA | R2 | 4 | 86.00 | 137 | 67 |
| 42168 | MAZDA | F8 | 4 | 86.00 | 131 | 48 |
| 42169 | MAZDA | JE-48 / JE-27 | 6 | 90.00 | 135 | 64 |

NUMERICAL INDEX

| TEIKIN NO | ENGINE MODEL | Cyl. | BORE Ø (mm) | PAGE | BOX NO. |
|-----------|-----------------------|------|-------------|------|---------|
| 42170 | MAZDA VC NEW | 4 | 80.00 | 127 | 31 |
| 42171 | MAZDA B6 | 4 | 78.00 | 123 | 16 |
| 42172 | MAZDA B6 - II | 4 | 78.00 | 124 | 17 |
| 42173 | MAZDA Z5 | 4 | 75.30 | 122 | 9 |
| 42174 | MAZDA S2 | 4 | 88.90 | 138 | 73 |
| 42179 | MAZDA ZB | 6 | 92.00 | 140 | 80 |
| 42183 | MAZDA TF | 4 | 105.50 | 143 | 93 |
| 42184AG | MAZDA TF-II | 4 | 105.50 | 144 | 94 |
| 42185 | MAZDA WL-T | 4 | 93.00 | 141 | 84 |
| 42186 | MAZDA WL | 4 | 93.00 | 141 | 83 |
| 42192 | MAZDA F2-II | 4 | 86.00 | 131 | 46 |
| 42193 | MAZDA FE-II | 4 | 86.00 | 132 | 50 |
| 42196 | MAZDA E5-II | 4 | 77.00 | 123 | 13 |
| 42198 | MAZDA SS K2700 | 4 | 92.00 | 140 | 78 |
| 42199 | MAZDA GY | 6 | 81.65 | 128 | 34 |
| 42200 | MAZDA BP-II | 4 | 83.00 | 129 | 38 |
| 42201 | MAZDA SL-III | 4 | 100.00 | 143 | 91 |
| 42202 | MAZDA FP | 4 | 83.00 | 129 | 40 |
| 42203 | MAZDA MA-IV | 4 | 80.00 | 127 | 30 |
| 42205 | MAZDA L3 | 4 | 87.50 | 133 | 55 |
| 42206 | MAZDA FE-VII | 4 | 86.00 | 133 | 53 |
| 42207 | MAZDA AJ | 6 | 89.00 | 135 | 62 |
| 42208 | MAZDA BP-III | 4 | 83.00 | 129 | 39 |
| 42209 | MAZDA L3-II | 4 | 87.50 | 133 | 56 |
| 42210 | MAZDA LF | 4 | 87.50 | 134 | 58 |
| 42211 | MAZDA Z6 | 4 | 78.00 | 126 | 25 |
| 42212AG | MAZDA MZ-DE | 4 | 93.00 | 141 | 82 |
| 42213AG | MAZDA MZR-CD | 4 | 96.00 | 142 | 89 |
| 42214 | MAZDA ZM | 4 | 78.00 | 126 | 27 |
| 42215AG | MAZDA W9 | 4 | 95.00 | 142 | 88 |
| 42216 | MAZDA LF-II | 4 | 87.50 | 134 | 59 |
| 42217 | MAZDA B3-III | 4 | 71.00 | 121 | 5 |
| 42218 | MAZDA FE-VIII | 4 | 86.00 | 133 | 54 |
| 42219 | MAZDA MZR 1.5L | 4 | 78.00 | 124 | 20 |
| 42220 | MAZDA SKYACTIV-G | 4 | 83.50 | 130 | 43 |
| 42221 | MAZDA MZR 2.3L | 4 | 87.50 | 134 | 60 |
| 42222 | MAZDA L3-III | 4 | 87.50 | 134 | 57 |
| 42223 | MAZDA SKYACTIV-G 2.5L | 4 | 89.00 | 135 | 61 |
| 42600 | MAZDA UC | 4 | 77.00 | 123 | 14 |
| 42601 | MAZDA PN | 4 | 78.00 | 137 | 66 |



NUMERICAL INDEX

| TEIKIN NO | ENGINE MODEL | | Cyl. | BORE Ø (mm) | PAGE | BOX NO. |
|-----------|--------------|----------|------|-------------|------|---------|
| 42602 | MAZDA | FE-III | 4 | 86.00 | 132 | 51 |
| 42603 | MAZDA | FE-IV | 4 | 86.00 | 132 | 52 |
| 42605 | MAZDA | XA | 4 | 88.90 | 139 | 75 |
| 42606 | MAZDA | S5 | 4 | 88.90 | 139 | 74 |
| 42607 | MAZDA | TC LATE | 4 | 73.00 | 121 | 7 |
| 42609 | MAZDA | HA-II | 4 | 95.00 | 142 | 87 |
| 42610AG | MAZDA | RF | 4 | 86.00 | 138 | 70 |
| 42611 | MAZDA | R2 LATE | 4 | 86.00 | 137 | 68 |
| 42612 | MAZDA | VA | 4 | 82.00 | 128 | 35 |
| 42613AG | MAZDA | SL-T | 4 | 100.00 | 143 | 92 |
| 42651 | MAZDA | TC | 4 | 73.00 | 121 | 6 |
| 42652 | MAZDA | E3-II | 4 | 77.00 | 122 | 11 |
| 42653 | MAZDA | B5 | 4 | 78.00 | 123 | 15 |
| 42655 | MAZDA | JE | 6 | 90.00 | 135 | 63 |
| 42656 | MAZDA | TB | 4 | 70.00 | 120 | 2 |
| 42657 | MAZDA | JS K2700 | 4 | 94.50 | 141 | 85 |
| 42658 | MAZDA | SF K2400 | 4 | 92.00 | 139 | 77 |
| 42659 | MAZDA | XA-II | 4 | 88.90 | 139 | 76 |
| 42660 | MAZDA | B3-II | 4 | 71.00 | 120 | 4 |
| 42661 | MAZDA | BP | 4 | 83.00 | 128 | 36 |
| 42662 | MAZDA | B6-T | 4 | 78.00 | 124 | 18 |
| 42663AG | MAZDA | TM | 4 | 109.00 | 144 | 95 |
| 42664 | MAZDA | KL | 6 | 84.50 | 130 | 44 |
| 42665 | MAZDA | KF | 6 | 78.00 | 126 | 28 |
| 42668 | MAZDA | B6ZE | 4 | 78.00 | 124 | 19 |
| 42669 | MAZDA | VB | 4 | 78.00 | 125 | 24 |
| 42670 | MAZDA | TC-II | 4 | 73.00 | 121 | 8 |
| 42671A | MAZDA | RF-II | 4 | 86.00 | 138 | 72 |
| 42672 | MAZDA | ZL-VE | 4 | 78.00 | 126 | 26 |
| 42674AG | MAZDA | R2 NEW | 4 | 86.00 | 137 | 69 |
| 42675AG | MAZDA | RF7 | 4 | 86.00 | 138 | 71 |
| 42676 | MAZDA | L8 | 4 | 83.00 | 130 | 42 |
| 42678 | MAZDA | F2T | 4 | 86.00 | 131 | 47 |
| 43102 | MAZDA | FE-III | 4 | 86.00 | 132 | 51 |
| 43104 | MAZDA | FE-IV | 4 | 86.00 | 132 | 52 |
| 43105 | MAZDA | XA | 4 | 88.90 | 139 | 75 |
| 43107 | MAZDA | S5 | 4 | 88.90 | 139 | 74 |
| 43115 | MAZDA | TC LATE | 4 | 73.00 | 121 | 7 |
| 43115N | MAZDA | HA-II | 4 | 95.00 | 142 | 87 |
| 43102 | MAZDA | RF | 4 | 86.00 | 138 | 70 |
| 43104 | MAZDA | R2 LATE | 4 | 86.00 | 137 | 68 |
| 43105 | MAZDA | VA | 4 | 82.00 | 128 | 35 |
| 43107 | MAZDA | SL-T | 4 | 100.00 | 143 | 92 |
| 43115 | MAZDA | TC | 4 | 73.00 | 121 | 6 |
| 43102 | MAZDA | E3-II | 4 | 77.00 | 122 | 11 |
| 43104 | MAZDA | B5 | 4 | 78.00 | 123 | 15 |
| 43105 | MAZDA | JE | 6 | 90.00 | 135 | 63 |
| 43107 | MAZDA | TB | 4 | 70.00 | 120 | 2 |
| 43115 | MAZDA | JS K2700 | 4 | 94.50 | 141 | 85 |
| 43102 | MAZDA | SF K2400 | 4 | 92.00 | 139 | 77 |
| 43104 | MAZDA | XA-II | 4 | 88.90 | 139 | 76 |
| 43105 | MAZDA | B3-II | 4 | 71.00 | 120 | 4 |
| 43107 | MAZDA | BP | 4 | 83.00 | 128 | 36 |
| 43115 | MAZDA | B6-T | 4 | 78.00 | 124 | 18 |
| 43102 | MAZDA | TM | 4 | 109.00 | 144 | 95 |
| 43104 | MAZDA | KL | 6 | 84.50 | 130 | 44 |
| 43105 | MAZDA | KF | 6 | 78.00 | 126 | 28 |
| 43107 | MAZDA | B6ZE | 4 | 78.00 | 124 | 19 |
| 43115 | MAZDA | VB | 4 | 78.00 | 125 | 24 |
| 43102 | MAZDA | TC-II | 4 | 73.00 | 121 | 8 |
| 43104 | MAZDA | RF-II | 4 | 86.00 | 138 | 72 |
| 43105 | MAZDA | ZL-VE | 4 | 78.00 | 126 | 26 |
| 43107 | MAZDA | R2 NEW | 4 | 86.00 | 137 | 69 |
| 43115 | MAZDA | RF7 | 4 | 86.00 | 138 | 71 |
| 43102 | MAZDA | L8 | 4 | 83.00 | 130 | 42 |
| 43104 | MAZDA | F2T | 4 | 86.00 | 131 | 47 |
| 43102 | MAZDA | FE-III | 4 | 86.00 | 132 | 51 |
| 43104 | MAZDA | FE-IV | 4 | 86.00 | 132 | 52 |
| 43105 | MAZDA | XA | 4 | 88.90 | 139 | 75 |
| 43107 | MAZDA | S5 | 4 | 88.90 | 139 | 74 |
| 43115 | MAZDA | TC LATE | 4 | 73.00 | 121 | 7 |
| 43102 | MAZDA | HA-II | 4 | 95.00 | 142 | 87 |
| 43104 | MAZDA | RF | 4 | 86.00 | 138 | 70 |
| 43105 | MAZDA | R2 LATE | 4 | 86.00 | 137 | 68 |
| 43107 | MAZDA | VA | 4 | 82.00 | 128 | 35 |
| 43115 | MAZDA | SL-T | 4 | 100.00 | 143 | 92 |
| 43102 | MAZDA | TC | 4 | 73.00 | 121 | 6 |
| 43104 | MAZDA | E3-II | 4 | 77.00 | 122 | 11 |
| 43105 | MAZDA | B5 | 4 | 78.00 | 123 | 15 |
| 43107 | MAZDA | JE | 6 | 90.00 | 135 | 63 |
| 43115 | MAZDA | TB | 4 | 70.00 | 120 | 2 |
| 43102 | MAZDA | JS K2700 | 4 | 94.50 | 141 | 85 |
| 43104 | MAZDA | SF K2400 | 4 | 92.00 | 139 | 77 |
| 43105 | MAZDA | XA-II | 4 | 88.90 | 139 | 76 |
| 43107 | MAZDA | B3-II | 4 | 71.00 | 120 | 4 |
| 43115 | MAZDA | BP | 4 | 83.00 | 128 | 36 |
| 43102 | MAZDA | B6-T | 4 | 78.00 | 124 | 18 |
| 43104 | MAZDA | TM | 4 | 109.00 | 144 | 95 |
| 43105 | MAZDA | KL | 6 | 84.50 | 130 | 44 |
| 43107 | MAZDA | KF | 6 | 78.00 | 126 | 28 |
| 43115 | MAZDA | B6ZE | 4 | 78.00 | 124 | 19 |
| 43102 | MAZDA | VB | 4 | 78.00 | 125 | 24 |
| 43104 | MAZDA | TC-II | 4 | 73.00 | 121 | 8 |
| 43105 | MAZDA | RF-II | 4 | 86.00 | 138 | 72 |
| 43107 | MAZDA | ZL-VE | 4 | 78.00 | 126 | 26 |
| 43115 | MAZDA | R2 NEW | 4 | 86.00 | 137 | 69 |
| 43102 | MAZDA | RF7 | 4 | 86.00 | 138 | 71 |
| 43104 | MAZDA | L8 | 4 | 83.00 | 130 | 42 |
| 43105 | MAZDA | F2T | 4 | 86.00 | 131 | 47 |
| 43102 | MAZDA | FE-III | 4 | 86.00 | 132 | 51 |
| 43104 | MAZDA | FE-IV | 4 | 86.00 | 132 | 52 |
| 43105 | MAZDA | XA | 4 | 88.90 | 139 | 75 |
| 43107 | MAZDA | S5 | 4 | 88.90 | 139 | 74 |
| 43115 | MAZDA | TC LATE | 4 | 73.00 | 121 | 7 |
| 43102 | MAZDA | HA-II | 4 | 95.00 | 142 | 87 |
| 43104 | MAZDA | RF | 4 | 86.00 | 138 | 70 |
| 43105 | MAZDA | R2 LATE | 4 | 86.00 | 137 | 68 |
| 43107 | MAZDA | VA | 4 | 82.00 | 128 | 35 |
| 43115 | MAZDA | SL-T | 4 | 100.00 | 143 | 92 |
| 43102 | MAZDA | TC | 4 | 73.00 | 121 | 6 |
| 43104 | MAZDA | E3-II | 4 | 77.00 | 122 | 11 |
| 43105 | MAZDA | B5 | 4 | 78.00 | 123 | 15 |
| 43107 | MAZDA | JE | 6 | 90.00 | 135 | 63 |
| 43115 | MAZDA | TB | 4 | 70.00 | 120 | 2 |
| 43102 | MAZDA | JS K2700 | 4 | 94.50 | 141 | 85 |
| 43104 | MAZDA | SF K2400 | 4 | 92.00 | 139 | 77 |
| 43105 | MAZDA | XA-II | 4 | 88.90 | 139 | 76 |
| 43107 | MAZDA | B3-II | 4 | 71.00 | 120 | 4 |
| 43115 | MAZDA | BP | 4 | 83.00 | 128 | 36 |
| 43102 | MAZDA | B6-T | 4 | 78.00 | 124 | 18 |
| 43104 | MAZDA | TM | 4 | 109.00 | 144 | 95 |
| 43105 | MAZDA | KL | 6 | 84.50 | 130 | 44 |
| 43107 | MAZDA | KF | 6 | 78.00 | 126 | 28 |
| 43115 | MAZDA | B6ZE | 4 | 78.00 | 124 | 19 |
| 43102 | MAZDA | VB | 4 | 78.00 | 125 | 24 |
| 43104 | MAZDA | TC-II | 4 | 73.00 | 121 | 8 |
| 43105 | MAZDA | RF-II | 4 | 86.00 | 138 | 72 |
| 43107 | MAZDA | ZL-VE | 4 | 78.00 | 126 | 26 |
| 43115 | MAZDA | R2 NEW | 4 | 86.00 | 137 | 69 |
| 43102 | MAZDA | RF7 | 4 | 86.00 | 138 | 71 |
| 43104 | MAZDA | L8 | 4 | 83.00 | 130 | 42 |
| 43105 | MAZDA | F2T | 4 | 86.00 | 131 | 47 |
| 43102 | MAZDA | FE-III | 4 | 86.00 | 132 | 51 |
| 43104 | MAZDA | FE-IV | 4 | 86.00 | 132 | 52 |
| 43105 | MAZDA | XA | 4 | 88.90 | 139 | 75 |
| 43107 | MAZDA | S5 | 4 | 88.90 | 139 | 74 |
| 43115 | MAZDA | TC LATE | 4 | 73.00 | 121 | 7 |
| 43102 | MAZDA | HA-II | 4 | 95.00 | 142 | 87 |
| 43104 | MAZDA | RF | 4 | 86.00 | 138 | 70 |
| 43105 | MAZDA | R2 LATE | 4 | 86.00 | 137 | 68 |
| 43107 | MAZDA | VA | 4 | 82.00 | 128 | 35 |
| 43115 | MAZDA | SL-T | 4 | 100.00 | 143 | 92 |
| 43102 | MAZDA | TC | 4 | 73.00 | 121 | 6 |
| 43104 | MAZDA | E3-II | 4 | 77.00 | 122 | 11 |
| 43105 | MAZDA | B5 | 4 | 78.00 | 123 | 15 |
| 43107 | MAZDA | JE | 6 | 90.00 | 135 | 63 |
| 43115 | MAZDA | TB | 4 | 70.00 | 120 | 2 |
| 43102 | MAZDA | JS K2700 | 4 | 94.50 | 141 | 85 |
| 43104 | MAZDA | SF K2400 | 4 | 92.00 | 139 | 77 |
| 43105 | MAZDA | XA-II | 4 | 88.90 | 139 | 76 |
| 43107 | MAZDA | B3-II | 4 | 71.00 | 120 | 4 |
| 43115 | MAZDA | BP | 4 | 83.00 | 128 | 36 |
| 43102 | MAZDA | B6-T | 4 | 78.00 | 124 | 18 |
| 43104 | MAZDA | TM | 4 | 109.00 | 144 | 95 |
| 43105 | MAZDA | KL | 6 | 84.50 | 130 | 44 |
| 43107 | MAZDA | KF | 6 | 78.00 | 126 | 28 |
| 43115 | MAZDA | B6ZE | 4 | 78.00 | 124 | 19 |
| 43102 | MAZDA | VB | 4 | 78.00 | 125 | 24 |
| 43104 | MAZDA | TC-II | 4 | 73.00 | 121 | 8 |
| 43105 | MAZDA | RF-II | 4 | 86.00 | 138 | 72 |
| 43107 | MAZDA | ZL-VE | 4 | 78.00 | 126 | 26 |
| 43115 | MAZDA | R2 NEW | 4 | 86.00 | 137 | 69 |
| 43102 | MAZDA | RF7 | 4 | 86.00 | 138 | 71 |
| 43104 | MAZDA | L8 | 4 | 83.00 | 130 | 42 |
| 43105 | MAZDA | F2T | 4 | 86.00 | 131 | 47 |
| 43102 | MAZDA | FE-III | 4 | 86.00 | 132 | 51 |
| 43104 | MAZDA | FE-IV | 4 | 86.00 | 132 | 52 |
| 43105 | MAZDA | XA | 4 | 88.90 | 139 | 75 |
| 43107 | MAZDA | S5 | 4 | 88.90 | 139 | 74 |
| 43115 | MAZDA | TC LATE | 4 | 73.00 | 121 | 7 |
| 43102 | MAZDA | HA-II | 4 | 95.00 | 142 | 87 |
| 43104 | MAZDA | RF | 4 | 86.00 | 138 | 70 |
| 43105 | MAZDA | R2 LATE | 4 | 86.00 | 137 | 68 |
| 43107 | MAZDA | VA | 4 | 82.00 | 128 | 35 |
| 43115 | MAZDA | SL-T | 4 | 100.00 | 143 | 92 |
| 43102 | MAZDA | TC | 4 | 73.00 | 121 | 6 |
| 43104 | MAZDA | E3-II | 4 | 77.00 | 122 | 11 |
| 43105 | MAZDA | B5 | 4 | 78.00 | 123 | 15 |
| 43107 | MAZDA | JE | 6 | 90.00 | 135 | 63 |
| 43115 | MAZDA | TB | 4 | 70.00 | 120 | 2 |
| 43102 | MAZDA | JS K2700 | 4 | 94.50 | 141 | 85 |
| 43104 | MAZDA | SF K2400 | 4 | 92.00 | 139 | 77 |
| 43105 | MAZDA | XA-II | 4 | 88.90 | 139 | 76 |
| 43107 | MAZDA | B3-II | 4 | 71.00 | 120 | 4 |
| 43115 | MAZDA | BP | 4 | 83.00 | 128 | 36 |
| 43102 | MAZDA | B6-T | 4 | 78.00 | 124 | 18 |
| 43104 | MAZDA | TM | 4 | 109.00 | 144 | 95 |
| 43105 | MAZDA | KL | 6 | 84.50 | 130 | 44 |
| 43107 | MAZDA | KF | 6 | 78.00 | 126 | 28 |
| 43115 | MAZDA | B6ZE | 4 | 78.00 | 124 | 19 |
| 43102 | MAZDA | VB | 4 | 78.00 | 125 | 24 |
| 43104 | MAZDA | TC-II | 4 | 73.00 | 121 | 8 |
| 43105 | MAZDA | RF-II | 4 | 86.00 | 138 | 72 |
| 43107 | MAZDA | ZL-VE | 4 | 78.00 | 126 | 26 |
| 43115 | MAZDA | R2 NEW | 4 | 86.00 | 137 | 69 |
| 43102 | MAZDA | RF7 | 4 | 86.00 | 138 | 71 |
| 43104 | MAZDA | L8 | 4 | 83.00 | 130 | 42 |
| 43105 | MAZDA | F2T | 4 | 86.00 | 131 | 47 |
| 43102 | MAZDA | FE-III | 4 | 86.00 | 132 | 51 |
| 43104 | MAZDA | FE-IV | 4 | 86.00 | 132 | 52 |
| 4 | | | | | | |



NUMERICAL INDEX

| TEIKIN NO | ENGINE MODEL | Cyl. | BORE Ø (mm) | PAGE | BOX NO. |
|-----------|-------------------------|------|-------------|------|---------|
| 43132 | mitsubishi 4G32 | 4 | 76.90 | 154 | 21 |
| 43132N | mitsubishi 4G32 NEW | 4 | 76.90 | 154 | 22 |
| 43137 | mitsubishi 4G33 | 4 | 73.00 | 151 | 9 |
| 43144 | mitsubishi 4G41R NEW | 4 | 76.50 | 153 | 20 |
| 43148 | mitsubishi 4G52 | 4 | 84.00 | 158 | 37 |
| 43151 | mitsubishi 4G53 OLD | 4 | 88.00 | 163 | 58 |
| 43153 | mitsubishi 4G54 | 4 | 91.10 | 163 | 59 |
| 43154 | mitsubishi 4G62 | 4 | 80.60 | 155 | 28 |
| 43155 | mitsubishi 4G63 OLD | 4 | 85.00 | 158 | 38 |
| 43157 | mitsubishi 4DR5 | 4 | 92.00 | 171 | 91 |
| 43164 | mitsubishi 4D30 OLD | 4 | 100.00 | 175 | 106 |
| 43166 | mitsubishi 4D30 | 4 | 100.00 | 175 | 105 |
| 43168 | mitsubishi 4D31 / 4D31T | 4 | 100.00 | 175 | 107 |
| 43168 | mitsubishi 6D31 / 6D31T | 6 | 100.00 | 176 | 108 |
| 43170 | mitsubishi 4D34 | 4 | 104.00 | 177 | 114 |
| 43171 | mitsubishi 4D55 / 4D56 | 4 | 91.10 | 169 | 83 |
| 43173 | mitsubishi 4D56T | 4 | 91.10 | 170 | 87 |
| 43176 | mitsubishi 2G23 | 2 | 70.00 | 149 | 3 |
| 43187 | mitsubishi G15B | 4 | 75.50 | 153 | 17 |
| 43195 | mitsubishi G37B | 4 | 80.60 | 156 | 29 |
| 43207 | mitsubishi G63B | 4 | 85.00 | 160 | 45 |
| 43216 | mitsubishi 4G17 | 4 | 72.20 | 150 | 8 |
| 43217 | mitsubishi 4G15 | 4 | 75.50 | 152 | 15 |
| 43218 | mitsubishi 6G72 | 6 | 91.10 | 164 | 64 |
| 43219 | mitsubishi 4G37 | 4 | 80.60 | 155 | 27 |
| 43220 | mitsubishi 6G72 NEW | 6 | 91.10 | 165 | 65 |
| 43221 | mitsubishi 4G32-M | 4 | 76.90 | 154 | 24 |
| 43222 | mitsubishi 4G63-P | 4 | 85.00 | 159 | 44 |
| 43223 | mitsubishi 6D16-T | 6 | 118.00 | 184 | 141 |
| 43224 | mitsubishi 4G32-III | 4 | 76.90 | 154 | 23 |
| 43225 | mitsubishi 4G64S | 4 | 86.50 | 161 | 52 |
| 43226 | mitsubishi 4G63DK | 4 | 85.00 | 158 | 40 |
| 43227 | mitsubishi 4D32 | 4 | 104.00 | 176 | 111 |
| 43228 | mitsubishi 4G64 | 4 | 86.50 | 161 | 49 |
| 43229 | mitsubishi 4D65T | 4 | 80.60 | 168 | 78 |
| 43230 | mitsubishi 420A | 4 | 87.50 | 162 | 55 |
| 43231 | mitsubishi 4G63D | 4 | 85.00 | 158 | 39 |
| 43232 | mitsubishi 4M40-T | 4 | 95.00 | 173 | 98 |
| 43233 | mitsubishi G54B, RWD | 4 | 91.10 | 164 | 61 |
| 43234 | mitsubishi 4G63D-T | 4 | 85.00 | 159 | 41 |



NUMERICAL INDEX

| TEIKIN NO | ENGINE MODEL | Cyl. | BORE Ø (mm) | PAGE | BOX NO. |
|-----------|------------------------|------|-------------|------|---------|
| 43235 | mitsubishi 6G72-T | 6 | 91.10 | 166 | 70 |
| 43241 | mitsubishi 4D65T OLD | 4 | 80.60 | 168 | 79 |
| 43242AG | mitsubishi 4D56-T LATE | 4 | 91.10 | 171 | 89 |
| 43244 | mitsubishi 4D33 | 4 | 108.00 | 179 | 120 |
| 43247 | mitsubishi 6G74 | 6 | 93.00 | 166 | 72 |
| 43248 | mitsubishi 4G15-II | 4 | 75.50 | 152 | 16 |
| 43249 | mitsubishi 6G72H | 6 | 91.10 | 165 | 66 |
| 43250 | mitsubishi 4G61 | 4 | 82.30 | 157 | 35 |
| 43257 | mitsubishi 4G13-II | 4 | 71.00 | 150 | 5 |
| 43258 | mitsubishi 4G64N | 4 | 86.50 | 161 | 51 |
| 43261 | mitsubishi 4G63K | 4 | 85.00 | 159 | 42 |
| 43263 | mitsubishi 6G73 | 6 | 83.50 | 157 | 36 |
| 43264 | mitsubishi 4D65 | 4 | 80.60 | 168 | 76 |
| 43265A | mitsubishi 6D16-1AT2 | 6 | 118.00 | 183 | 139 |
| 43266A | mitsubishi 6D16-2A | 6 | 118.00 | 184 | 140 |
| 43267 | mitsubishi 6D17-1A | 6 | 118.00 | 184 | 142 |
| 43268A | mitsubishi 6D16-1A | 6 | 118.00 | 183 | 138 |
| 43270 | mitsubishi 4G64-II | 4 | 86.50 | 161 | 50 |
| 43271 | mitsubishi 6G74-II | 6 | 93.00 | 167 | 73 |
| 43272 | mitsubishi G15B-II | 4 | 75.50 | 153 | 18 |
| 43273 | mitsubishi G54BT | 4 | 91.10 | 164 | 63 |
| 43274 | mitsubishi 6D22-T | 6 | 130.00 | 185 | 145 |
| 43275A | mitsubishi 8DC91-T | 8 | 135.00 | 186 | 148 |
| 43276 | mitsubishi G64FR | 4 | 86.50 | 162 | 53 |
| 43278 | mitsubishi 6G72-II | 6 | 91.10 | 165 | 67 |
| 43279 | mitsubishi 4G63N | 4 | 85.00 | 159 | 43 |
| 43280 | mitsubishi 4D36 | 4 | 104.00 | 178 | 118 |
| 43281 | mitsubishi 4G18 | 4 | 76.00 | 153 | 19 |
| 43282 | mitsubishi 4G13-IV | 4 | 71.00 | 150 | 7 |
| 43283A | mitsubishi 6D15-II | 6 | 113.00 | 182 | 132 |
| 43284 | mitsubishi 6G74-III | 6 | 93.00 | 167 | 74 |
| 43285 | mitsubishi 4D56-II | 4 | 91.10 | 170 | 86 |
| 43286 | mitsubishi 4D65-II | 4 | 80.60 | 168 | 77 |
| 43287 | mitsubishi 4G69 | 4 | 87.00 | 162 | 54 |
| 43288 | mitsubishi 4G94 | 4 | 81.50 | 157 | 34 |
| 43289 | mitsubishi 6D14.A | 6 | 110.00 | 180 | 125 |
| 43290 | mitsubishi 6G75 | 6 | 95.00 | 167 | 75 |
| 43291 | mitsubishi 4D56 LATE | 4 | 91.10 | 170 | 85 |
| 43292 | mitsubishi 4G54C | 4 | 91.10 | 163 | 60 |
| 43293AG | mitsubishi 4D34T NEW | 4 | 104.00 | 178 | 116 |

NUMERICAL INDEX

| TEIKIN NO | ENGINE MODEL | Cyl. | BORE Ø (mm) | PAGE | BOX NO. |
|-----------|----------------------------|------|-------------|------|---------|
| 43294 | mitsubishi 6G72-V | 6 | 91.10 | 166 | 71 |
| 43296 | mitsubishi 3A92 | 3 | 75.00 | 152 | 13 |
| 43297 | mitsubishi 6B31 | 6 | 87.60 | 162 | 56 |
| 43600 | mitsubishi 4G13 | 4 | 71.00 | 149 | 4 |
| 43605 | mitsubishi 4D34T | 4 | 104.00 | 177 | 115 |
| 43605-6 | mitsubishi 6D34T | 6 | 104.00 | 178 | 119 |
| 43606 | mitsubishi 4G36 | 4 | 73.00 | 151 | 10 |
| 43607 | mitsubishi 4G12 | 4 | 74.00 | 151 | 11 |
| 43608 | mitsubishi 4D35 | 4 | 110.00 | 179 | 121 |
| 43609 | mitsubishi 4DR51/4DR5 LATE | 4 | 92.00 | 172 | 92 |
| 43610 | mitsubishi 4DR7 | 4 | 95.00 | 173 | 96 |
| 43612 | mitsubishi 4D68T | 4 | 82.70 | 169 | 81 |
| 43613 | mitsubishi 4D68 | 4 | 82.70 | 169 | 80 |
| 43614 | mitsubishi 6D22 | 6 | 130.00 | 185 | 144 |
| 43615 | mitsubishi 6D14-T | 6 | 110.00 | 180 | 126 |
| 43616 | mitsubishi 4G11 | 4 | 69.50 | 149 | 2 |
| 43617 | mitsubishi 4D31 T | 4 | 100.00 | 176 | 109 |
| 43618 | mitsubishi 8DC8 | 8 | 135.00 | 185 | 146 |
| 43619 | mitsubishi 4D32 LATE | 4 | 104.00 | 177 | 112 |
| 43621 | mitsubishi G63B-II | 4 | 85.00 | 160 | 46 |
| 43652 | mitsubishi 4G13-III | 4 | 71.00 | 150 | 6 |
| 43654 | mitsubishi G54B-II | 4 | 91.10 | 164 | 62 |
| 43655 | mitsubishi S4E | 4 | 94.00 | 172 | 93 |
| 43656 | mitsubishi G32S | 4 | 76.90 | 155 | 25 |
| 43657 | mitsubishi 4G92S-H | 4 | 81.00 | 156 | 31 |
| 43658 | mitsubishi 4G93 | 4 | 81.00 | 156 | 32 |
| 43659A | mitsubishi 8DC11 | 8 | 142.00 | 186 | 149 |
| 43660A | mitsubishi 8DC9 | 8 | 135.00 | 185 | 147 |
| 43661 | mitsubishi 4D56-T LATE-II | 4 | 91.10 | 171 | 90 |
| 43663AG | mitsubishi 4M41-T | 4 | 98.50 | 175 | 104 |
| 43664A | mitsubishi 4D31-T LATE | 4 | 100.00 | 176 | 110 |
| 43665A | mitsubishi 6D14-T.2A | 6 | 110.00 | 180 | 127 |
| 43666 | mitsubishi 4D32 NEW | 4 | 104.00 | 177 | 113 |
| 43667 | mitsubishi 6G72-IV | 6 | 91.10 | 166 | 69 |
| 43668A | mitsubishi 6D14-T-II | 6 | 110.00 | 181 | 128 |
| 43669 | mitsubishi 6G72-III | 6 | 91.10 | 165 | 68 |
| 43670AG | mitsubishi 4M40-T-II | 4 | 95.00 | 173 | 99 |
| 43671 | mitsubishi 4G92S | 4 | 81.00 | 156 | 30 |
| 43672AG | mitsubishi 4D55T/4D56T-II | 4 | 91.10 | 170 | 84 |
| 43673A | mitsubishi 4M40 | 4 | 95.00 | 173 | 97 |



NUMERICAL INDEX

| TEIKIN NO | ENGINE MODEL | | Cyl. | BORE Ø (mm) | PAGE | BOX NO. |
|-----------|--------------|--------------|------|-------------|------|---------|
| 43674A | mitsubishi | 4M51 | 4 | 118.00 | 182 | 135 |
| 43675A | mitsubishi | 6D15.3AT | 6 | 113.00 | 181 | 131 |
| 43676 | mitsubishi | G63DH | 4 | 85.00 | 160 | 47 |
| 43677 | mitsubishi | 6A12 | 6 | 78.40 | 155 | 26 |
| 43678AG | mitsubishi | 4D56T CDRI | 4 | 91.10 | 171 | 88 |
| 43679 | mitsubishi | 4G93-II | 4 | 81.00 | 157 | 33 |
| 43680 | mitsubishi | 4A31 | 4 | 66.00 | 149 | 1 |
| 43681AG | mitsubishi | 4M42-0AT | 4 | 95.00 | 174 | 100 |
| 43682 | mitsubishi | S4S | 4 | 94.00 | 172 | 94 |
| 43682-6 | mitsubishi | S6S | 6 | 94.00 | 172 | 95 |
| 43683 | mitsubishi | 4M51T | 4 | 118.00 | 183 | 136 |
| 43684A | mitsubishi | 6D14.3AT | 6 | 110.00 | 180 | 124 |
| 43685AG | mitsubishi | 4M50T | 4 | 114.00 | 182 | 134 |
| 43686A | mitsubishi | 6D15-III | 6 | 113.00 | 182 | 133 |
| 43687 | mitsubishi | 4DQ5 | 4 | 84.00 | 169 | 82 |
| 43688 | mitsubishi | S4E2 | 4 | 98.00 | 174 | 101 |
| 43691AG | mitsubishi | 4D35 / 4D35T | 4 | 110.00 | 179 | 122 |
| 43692 | mitsubishi | 4B11 | 4 | 86.00 | 160 | 48 |
| 43693A | mitsubishi | 4D34T-II | 4 | 104.00 | 178 | 117 |
| 43694 | mitsubishi | 4B12 | 4 | 88.00 | 163 | 57 |
| 43695AG | mitsubishi | 6M61 | 6 | 118.00 | 184 | 143 |
| 43696-3 | mitsubishi | 3A91 | 3 | 75.00 | 151 | 12 |
| 43696 | mitsubishi | 4A91 | 4 | 75.00 | 152 | 14 |
| 44102 | NISSAN | A12 1970 | 4 | 73.00 | 188 | 8 |
| 44109 | NISSAN | A14S, A14 | 4 | 76.00 | 191 | 17 |
| 44114 | NISSAN | A15S, A15 | 4 | 76.00 | 191 | 19 |
| 44121 | NISSAN | J15, J16 | 4 | 77.95 | 195 | 36 |
| 44122 | NISSAN | E10S, E10 | 4 | 73.00 | 189 | 9 |
| 44125 | NISSAN | E15S, E15 | 4 | 76.00 | 192 | 22 |
| 44160 | NISSAN | L24/L26 | 4 | 83.00 | 198 | 48 |
| 44160 | NISSAN | L24/L26 | 6 | 83.00 | 199 | 52 |
| 44166 | NISSAN | L18 NEW 1970 | 4 | 85.00 | 201 | 60 |
| 44167 | NISSAN | L18 OLD | 4 | 85.00 | 202 | 61 |
| 44176 | NISSAN | LD20 | 4 | 85.00 | 215 | 112 |
| 44186 | NISSAN | CA16 | 4 | 78.00 | 196 | 38 |
| 44190 | NISSAN | CA18 | 4 | 83.00 | 198 | 46 |
| 44193 | NISSAN | CA20 | 4 | 84.50 | 201 | 57 |
| 44196 | NISSAN | H20, H20P | 4 | 87.20 | 206 | 79 |
| 44210 | NISSAN | SD22 | 4 | 83.00 | 213 | 105 |

NUMERICAL INDEX

| TEIKIN NO | ENGINE MODEL | Cyl. | BORE Ø (mm) | PAGE | BOX NO. |
|-----------|--------------------------|------|-------------|------|---------|
| 44210-6 | NISSAN SD23 | 6 | 83.00 | 213 | 107 |
| 44215 | NISSAN SD23 / SD25 | 4 | 89.00 | 217 | 120 |
| 44224 | NISSAN Z20 | 4 | 85.00 | 202 | 63 |
| 44227 | NISSAN Z20S | 4 | 85.00 | 202 | 64 |
| 44230 | NISSAN Z22S | 4 | 87.00 | 205 | 74 |
| 44232 | NISSAN Z24, Z24i | 4 | 89.00 | 209 | 92 |
| 44235 | NISSAN P680 | 6 | 85.73 | 203 | 65 |
| 44236 | NISSAN PD6 | 6 | 125.00 | 228 | 165 |
| 44242 | NISSAN RD8 | 8 | 135.00 | 229 | 169 |
| 44244 | NISSAN ND6 | 6 | 110.00 | 227 | 162 |
| 44246 | NISSAN NE6 | 6 | 110.00 | 227 | 163 |
| 44255 | NISSAN TD25 | 4 | 92.90 | 218 | 126 |
| 44256 | NISSAN A10 | 4 | 73.00 | 188 | 7 |
| 44258 | NISSAN GA16i, GA16DS | 4 | 76.00 | 194 | 31 |
| 44259 | NISSAN E16i | 4 | 76.00 | 193 | 25 |
| 44260 | NISSAN GA16DE | 4 | 76.00 | 193 | 27 |
| 44261 | NISSAN FE6T | 6 | 108.00 | 226 | 157 |
| 44262 | NISSAN CD17 | 4 | 80.00 | 213 | 104 |
| 44263 | NISSAN LD20-II | 4 | 85.00 | 215 | 113 |
| 44264A | NISSAN RE8 | 8 | 135.00 | 229 | 170 |
| 44264A-10 | NISSAN RE10 | 10 | 135.00 | 229 | 171 |
| 44265 | NISSAN J18 | 4 | 80.50 | 197 | 44 |
| 44266 | NISSAN TD23 | 4 | 89.00 | 217 | 122 |
| 44267 | NISSAN TD27 | 4 | 96.00 | 219 | 130 |
| 44267 | NISSAN TD27 | 6 | 96.00 | 220 | 135 |
| 44268 | NISSAN E16 | 4 | 76.00 | 192 | 24 |
| 44269 | NISSAN Z16 | 4 | 83.00 | 199 | 51 |
| 44270 | NISSAN GA16DE-II | 4 | 76.00 | 193 | 28 |
| 44271 | NISSAN KA24E | 4 | 89.00 | 208 | 85 |
| 44272 | NISSAN KA24E-II | 4 | 89.00 | 208 | 86 |
| 44273 | NISSAN VQ30DE | 6 | 93.00 | 210 | 96 |
| 44274 | NISSAN VG33E | 6 | 91.50 | 210 | 94 |
| 44275 | NISSAN VG30E | 6 | 87.00 | 205 | 76 |
| 44276 | NISSAN VG30DE | 6 | 87.00 | 205 | 75 |
| 44277 | NISSAN VG30i / VG30E OLD | 6 | 87.00 | 206 | 77 |
| 44278 | NISSAN Z22 | 4 | 87.00 | 205 | 73 |
| 44279 | NISSAN CA20-II | 4 | 84.50 | 201 | 58 |
| 44283 | NISSAN L16-III/L26-II | 4 | 83.00 | 199 | 49 |
| 44290 | NISSAN RF8 | 8 | 138.00 | 230 | 172 |
| 44290 | NISSAN RF10 | 10 | 138.00 | 230 | 173 |



NUMERICAL INDEX

| TEIKIN NO | ENGINE MODEL | Cyl. | BORE Ø (mm) | PAGE | BOX NO. |
|-----------|-------------------------|------|-------------|------|---------|
| 44291 | NISSAN SD22-II | 4 | 83.00 | 213 | 106 |
| 44295 | NISSAN LD23 | 4 | 87.00 | 216 | 119 |
| 44296 | NISSAN TD27-T - II | 4 | 96.00 | 220 | 133 |
| 44297 | NISSAN QD32 | 4 | 99.20 | 222 | 143 |
| 44305 | NISSAN L20B | 4 | 85.00 | 202 | 62 |
| 44306 | NISSAN GA16DS-II, GA16S | 4 | 76.00 | 194 | 30 |
| 44316 | NISSAN Z24-II | 4 | 89.00 | 210 | 93 |
| 44320A | NISSAN NE6T | 6 | 110.00 | 228 | 164 |
| 44321 | NISSAN KA24DE | 4 | 89.00 | 207 | 83 |
| 44322 | NISSAN A14-II | 4 | 76.00 | 190 | 16 |
| 44323A | NISSAN FD6T | 6 | 100.00 | 224 | 148 |
| 44324 | NISSAN A15-II | 4 | 76.00 | 191 | 18 |
| 44325 | NISSAN VQ30DE-II | 6 | 93.00 | 211 | 97 |
| 44326 | NISSAN CG13DE | 4 | 71.00 | 187 | 4 |
| 44327 | NISSAN CG10DE | 4 | 71.00 | 187 | 3 |
| 44328 | NISSAN QR25DE | 4 | 89.00 | 208 | 88 |
| 44329 | NISSAN E16-T | 4 | 76.00 | 193 | 26 |
| 44330A | NISSAN PE6-T | 6 | 133.00 | 229 | 168 |
| 44331 | NISSAN VQ35DE-II | 6 | 95.50 | 211 | 99 |
| 44332 | NISSAN VQ35DE | 6 | 95.50 | 211 | 98 |
| 44333 | NISSAN QG18DE-II | 4 | 80.00 | 197 | 43 |
| 44334 | NISSAN VG30i-II | 6 | 87.00 | 206 | 78 |
| 44335 | NISSAN L28S | 6 | 86.00 | 204 | 71 |
| 44336 | NISSAN L24S | 6 | 83.00 | 200 | 54 |
| 44337 | NISSAN GA15DS-II | 4 | 73.60 | 190 | 13 |
| 44338 | NISSAN KA24DE-IV | 4 | 89.00 | 207 | 84 |
| 44339 | NISSAN HR15DE | 4 | 78.00 | 196 | 39 |
| 44340 | NISSAN MR18DE | 4 | 84.00 | 200 | 55 |
| 44341 | NISSAN VQ40DE | 6 | 95.50 | 211 | 100 |
| 44342 | NISSAN QR20DE | 4 | 89.00 | 208 | 87 |
| 44343 | NISSAN QR25DE-III | 4 | 89.00 | 209 | 89 |
| 44344A | NISSAN FE6T-II | 6 | 108.00 | 227 | 161 |
| 44345 | NISSAN HR16DE | 4 | 78.00 | 196 | 40 |
| 44347 | NISSAN TB45DE/TB48DE | 6 | 99.50 | 212 | 103 |
| 44348A | NISSAN FE6-TC | 6 | 108.00 | 227 | 160 |
| 44349 | NISSAN QR25DE-IV | 4 | 89.00 | 209 | 90 |
| 44350 | NISSAN MR20DE | 4 | 84.00 | 200 | 56 |
| 44351 | NISSAN HR12DE | 3 | 78.00 | 196 | 37 |
| 44352 | NISSAN NA20-II | 4 | 86.00 | 203 | 67 |
| 44353 | NISSAN QR25DE-V | 4 | 89.00 | 209 | 91 |

NUMERICAL INDEX

| TEIKIN NO | ENGINE MODEL | Cyl. | BORE Ø (mm) | PAGE | BOX NO. |
|-----------|-------------------|------|-------------|------|---------|
| 44355 | NISSAN E15-III | 4 | 76.00 | 192 | 21 |
| 44600 | NISSAN MA10 | 4 | 68.00 | 187 | 1 |
| 44601 | NISSAN SR20DE | 4 | 86.00 | 203 | 68 |
| 44602 | NISSAN CD20 | 4 | 84.50 | 214 | 109 |
| 44603 | NISSAN SD33T | 6 | 83.00 | 214 | 108 |
| 44604 | NISSAN NA20 | 4 | 86.00 | 203 | 66 |
| 44605 | NISSAN ED33 | 4 | 100.00 | 223 | 145 |
| 44606 | NISSAN RD28 | 6 | 85.00 | 215 | 115 |
| 44608 | NISSAN H20-II | 4 | 87.20 | 206 | 80 |
| 44609 | NISSAN GA13 | 4 | 71.00 | 188 | 6 |
| 44610 | NISSAN GA15DS | 4 | 73.60 | 189 | 12 |
| 44611 | NISSAN E13 | 4 | 76.00 | 191 | 20 |
| 44614 | NISSAN GA14DS | 4 | 73.60 | 189 | 11 |
| 44615 | NISSAN NA16S | 4 | 81.50 | 198 | 45 |
| 44616 | NISSAN L28 | 6 | 86.00 | 204 | 70 |
| 44617 | NISSAN L24E | 6 | 83.00 | 200 | 53 |
| 44618 | NISSAN FD46 | 4 | 108.00 | 225 | 155 |
| 44619 | NISSAN BD30 | 4 | 96.00 | 219 | 128 |
| 44620 | NISSAN FD35 | 4 | 102.50 | 225 | 152 |
| 44621AG | NISSAN TD27-T | 4 | 96.00 | 220 | 132 |
| 44621AG-6 | NISSAN TD42-T | 6 | 96.00 | 221 | 137 |
| 44622 | NISSAN SD23/25-II | 4 | 89.00 | 217 | 121 |
| 44623AG | NISSAN RD28-T | 6 | 85.00 | 216 | 116 |
| 44624 | NISSAN LD20-T | 4 | 85.00 | 215 | 114 |
| 44625 | NISSAN LD28 | 6 | 84.50 | 214 | 111 |
| 44629A | NISSAN FD33-T | 4 | 100.00 | 223 | 147 |
| 44630 | NISSAN TD27-LATE | 4 | 96.00 | 219 | 131 |
| 44630-6 | NISSAN TD42-LATE | 6 | 96.00 | 221 | 136 |
| 44650 | NISSAN MA10-II | 4 | 68.00 | 187 | 2 |
| 44652 | NISSAN SR20DE-II | 4 | 86.00 | 204 | 69 |
| 44653 | NISSAN RB20E | 6 | 78.00 | 197 | 41 |
| 44654AG | NISSAN BD30T | 4 | 96.00 | 219 | 129 |
| 44655A | NISSAN PE6 | 6 | 133.00 | 228 | 167 |
| 44656A | NISSAN FE6TA | 6 | 108.00 | 226 | 159 |
| 44657A | NISSAN FD6T-II | 6 | 100.00 | 224 | 149 |
| 44658A | NISSAN FD6T-III | 6 | 100.00 | 224 | 150 |
| 44659 | NISSAN FD35-T | 4 | 102.50 | 225 | 153 |
| 44660 | NISSAN TB42/ E/ S | 6 | 96.00 | 212 | 101 |
| 44661 | NISSAN CA18ET | 4 | 83.00 | 198 | 47 |
| 44662 | NISSAN L16-III | 4 | 83.00 | 199 | 50 |



NUMERICAL INDEX

| TEIKIN NO | ENGINE MODEL | | Cyl. | BORE Ø (mm) | PAGE | BOX NO. |
|-----------|--------------|--------------------|------|-------------|------|---------|
| 44663 | NISSAN | CA20-III | 4 | 84.50 | 201 | 59 |
| 44664 | NISSAN | RB30E | 6 | 86.00 | 204 | 72 |
| 44665AG | NISSAN | FD42 | 4 | 108.00 | 225 | 154 |
| 44666A | NISSAN | TD25 LATE | 4 | 92.90 | 218 | 127 |
| 44667A | NISSAN | FE6 | 6 | 108.00 | 226 | 156 |
| 44668 | NISSAN | E15-T | 4 | 76.00 | 192 | 23 |
| 44669 | NISSAN | GA14 | 4 | 73.60 | 189 | 10 |
| 44670 | NISSAN | ED30 | 4 | 98.00 | 222 | 142 |
| 44671AG | NISSAN | YD25TDI | 4 | 89.00 | 218 | 124 |
| 44672AG | NISSAN | ZD30 | 4 | 96.00 | 221 | 138 |
| 44673AG | NISSAN | ZD30 LATE | 4 | 96.00 | 221 | 139 |
| 44674AG | NISSAN | TD27-T NEW | 4 | 96.00 | 220 | 134 |
| 44675 | NISSAN | K21 | 4 | 89.00 | 207 | 81 |
| 44676 | NISSAN | K25 | 4 | 89.00 | 207 | 82 |
| 44677 | NISSAN | QG15DE | 4 | 73.60 | 190 | 15 |
| 44678AG | NISSAN | ZD30DDTI | 4 | 96.00 | 222 | 141 |
| 44679A | NISSAN | PD6-T | 6 | 125.00 | 228 | 166 |
| 44680 | NISSAN | VK56DE | 8 | 98.00 | 212 | 102 |
| 44681AG | NISSAN | CD20-T | 4 | 84.50 | 214 | 110 |
| 44682 | NISSAN | QG18DE | 4 | 80.00 | 197 | 42 |
| 44683AG | NISSAN | QD32TI | 4 | 99.20 | 223 | 144 |
| 44684AG | NISSAN | YD25TDI NEW | 4 | 89.00 | 218 | 125 |
| 44685AG | NISSAN | YD22DDT/ETI | 4 | 86.00 | 216 | 118 |
| 44686AG | NISSAN | YD25DDTI | 4 | 89.00 | 217 | 123 |
| 44687 | NISSAN | CG13DE-II | 4 | 71.00 | 188 | 5 |
| 44688 | NISSAN | QG16 | 4 | 76.00 | 194 | 32 |
| 44689 | NISSAN | VQ20 | 6 | 76.00 | 195 | 34 |
| 44690 | NISSAN | QG16DE | 4 | 76.00 | 195 | 33 |
| 44691 | NISSAN | QG15 | 4 | 73.60 | 190 | 14 |
| 44692A | NISSAN | FE6T NEW | 6 | 108.00 | 226 | 158 |
| 44693 | NISSAN | VQ20-II | 6 | 76.00 | 195 | 35 |
| 44694A | NISSAN | ED35 | 4 | 102.50 | 224 | 151 |
| 44695 | NISSAN | GA16DE-III | 4 | 76.00 | 194 | 29 |
| 44697AG | NISSAN | YD22DDT/DDTI | 4 | 86.00 | 216 | 117 |
| 44698A | NISSAN | FD33 | 4 | 100.00 | 223 | 146 |
| 44699 | NISSAN | H25 | 4 | 92.00 | 210 | 95 |
| 44702AG | NISSAN | ZD30DD | 4 | 96.00 | 222 | 140 |
| 45114 | SUZUKI | F8A, ST90, LJ80 | 4 | 62.00 | 244 | 2 |
| 45117 | SUZUKI | F10A, ST100, SJ410 | 4 | 65.50 | 244 | 4 |

NUMERICAL INDEX

| TEIKIN NO | ENGINE MODEL | Cyl. | BORE Ø (mm) | PAGE | BOX NO. |
|-----------|----------------------|------|-------------|------|---------|
| 45122 | SUZUKI SS80 | 3 | 68.50 | 245 | 8 |
| 45123 | SUZUKI SL413 | 4 | 75.00 | 250 | 27 |
| 45124 | SUZUKI G16KV | 4 | 75.00 | 250 | 26 |
| 45125 | SUZUKI G10 NEW, G10A | 3 | 74.00 | 247 | 14 |
| 45125-4 | SUZUKI G13 NEW | 4 | 74.00 | 247 | 16 |
| 45126 | SUZUKI G10 | 3 | 74.00 | 247 | 13 |
| 45126-4 | SUZUKI G13 | 4 | 74.00 | 247 | 15 |
| 45127 | SUZUKI G16A, G16KC | 4 | 75.00 | 249 | 24 |
| 45128 | SUZUKI G13B | 4 | 74.00 | 248 | 17 |
| 45131-4 | SUZUKI J18 | 4 | 84.00 | 253 | 37 |
| 45131 | SUZUKI H25A | 6 | 84.00 | 253 | 38 |
| 45132 | SUZUKI VITARA | 4 | 75.00 | 251 | 29 |
| 45133 | SUZUKI J20A | 4 | 84.00 | 252 | 34 |
| 45134 | SUZUKI H20A | 6 | 78.00 | 252 | 33 |
| 45135 | SUZUKI STEAM 1.3L | 4 | 74.00 | 249 | 22 |
| 45136 | SUZUKI ALTO | 4 | 68.00 | 245 | 6 |
| 45137 | SUZUKI H27 | 6 | 88.00 | 253 | 39 |
| 45138 | SUZUKI F6A | 3 | 65.00 | 244 | 3 |
| 45139 | SUZUKI J24B | 4 | 92.00 | 254 | 42 |
| 45140 | SUZUKI AERIO | 4 | 90.00 | 254 | 41 |
| 45141 | SUZUKI K12A | 4 | 71.00 | 246 | 10 |
| 45142 | SUZUKI H27-II | 6 | 88.00 | 253 | 40 |
| 45143 | SUZUKI M15A | 4 | 78.00 | 251 | 31 |
| 45144 | SUZUKI G16B-II | 4 | 75.00 | 250 | 25 |
| 45145 | SUZUKI K10B | 3 | 73.00 | 246 | 11 |
| 45146-3 | SUZUKI ALTO LXI | 3 | 68.50 | 245 | 7 |
| 45146 | SUZUKI WAGON R | 4 | 68.50 | 246 | 9 |
| 45147 | SUZUKI SX4 | 4 | 84.00 | 252 | 36 |
| 45148 | SUZUKI K14B | 4 | 73.00 | 246 | 12 |
| 45149 | SUZUKI G15A | 4 | 75.00 | 249 | 23 |
| 45150 | SUZUKI J20A-II | 4 | 84.00 | 252 | 35 |
| 45151 | SUZUKI K6A | 3 | 68.00 | 245 | 5 |
| 45601 | SUZUKI SWIFT 1.6 | 4 | 75.00 | 250 | 28 |
| 45650 | SUZUKI G13-II | 4 | 74.00 | 248 | 20 |
| 45652 | SUZUKI F8A | 4 | 62.00 | 244 | 1 |
| 45653 | SUZUKI G13BB | 4 | 74.00 | 248 | 18 |
| 45654 | SUZUKI G13B-II | 4 | 74.00 | 248 | 19 |
| 45655 | SUZUKI G13-Y58 | 4 | 74.00 | 249 | 21 |
| 45656 | SUZUKI M13A | 4 | 78.00 | 251 | 30 |
| 45657 | SUZUKI M15A-II | 4 | 78.00 | 251 | 32 |

NUMERICAL INDEX

| TEIKIN NO | ENGINE MODEL | Cyl. | BORE Ø (mm) | PAGE | BOX NO. |
|-----------|------------------------|------|-------------|------|---------|
| 46103 | TOYOTA 3K | 4 | 75.00 | 263 | 21 |
| 46105 | TOYOTA 4K , 4KU | 4 | 75.00 | 263 | 22 |
| 46107 | TOYOTA 5K | 4 | 80.50 | 269 | 45 |
| 46112 | TOYOTA 1C | 4 | 83.00 | 294 | 145 |
| 46116 | TOYOTA 1S | 4 | 80.50 | 267 | 40 |
| 46118 | TOYOTA 1Y | 4 | 86.00 | 278 | 83 |
| 46119 | TOYOTA 2Y | 4 | 86.00 | 278 | 84 |
| 46120 | TOYOTA 3Y | 4 | 86.00 | 281 | 94 |
| 46122 | TOYOTA 4Y | 4 | 91.00 | 286 | 116 |
| 46123 | TOYOTA B, BU-15 | 4 | 95.00 | 304 | 187 |
| 46124 | TOYOTA B, BU-30 | 4 | 95.00 | 304 | 188 |
| 46127 | TOYOTA 2B | 4 | 98.00 | 307 | 198 |
| 46128 | TOYOTA 3B | 4 | 102.00 | 309 | 206 |
| 46130 | TOYOTA 13B | 4 | 102.00 | 308 | 202 |
| 46132 | TOYOTA F, FA-90 | 6 | 90.00 | 286 | 115 |
| 46136 | TOYOTA 2F | 6 | 94.00 | 288 | 122 |
| 46138 | TOYOTA 3F | 6 | 94.00 | 289 | 125 |
| 46141 | TOYOTA 2E | 4 | 73.00 | 260 | 10 |
| 46163 | TOYOTA 3A, 3AU | 4 | 77.50 | 265 | 32 |
| 46175 | TOYOTA 5R OLD | 4 | 88.00 | 284 | 108 |
| 46177 | TOYOTA 5R NEW | 4 | 88.00 | 284 | 107 |
| 46187 | TOYOTA 12R, 12RU | 4 | 80.50 | 267 | 39 |
| 46189 | TOYOTA 18R, 18RC, 18RB | 4 | 88.50 | 285 | 109 |
| 46199 | TOYOTA 21R, 21RC | 4 | 84.00 | 274 | 68 |
| 46201 | TOYOTA 22R | 4 | 92.00 | 287 | 117 |
| 46202 | TOYOTA 22R-E | 4 | 92.00 | 287 | 118 |
| 46207 | TOYOTA 2T, 2T-B | 4 | 85.00 | 276 | 73 |
| 46211 | TOYOTA 2T, 2T-U | 4 | 85.00 | 276 | 74 |
| 46218 | TOYOTA 3T, 3T-U, 13T-U | 4 | 85.00 | 277 | 77 |
| 46226 | TOYOTA 2J | 4 | 88.00 | 298 | 163 |
| 46226-6 | TOYOTA H NEW | 6 | 88.00 | 299 | 165 |
| 46231 | TOYOTA 2H | 6 | 91.00 | 300 | 171 |
| 46234 | TOYOTA L OLD, LN30 | 4 | 90.00 | 300 | 169 |
| 46236 | TOYOTA L NEW, LN50 | 4 | 90.00 | 299 | 167 |
| 46238 | TOYOTA L NEW-II | 4 | 90.00 | 299 | 168 |
| 46240 | TOYOTA 2L | 4 | 92.00 | 301 | 174 |
| 46242 | TOYOTA 2D OLD | 6 | 105.00 | 310 | 210 |
| 46244 | TOYOTA 2D NEW | 6 | 105.00 | 310 | 209 |
| 46253 | TOYOTA 4AGEC, 4AGEU | 4 | 81.00 | 272 | 57 |
| 46254 | TOYOTA 14B | 4 | 102.00 | 308 | 204 |

NUMERICAL INDEX

| TEIKIN NO | ENGINE MODEL | Cyl. | BORE Ø (mm) | PAGE | BOX NO. |
|-----------|------------------------|------|-------------|------|---------|
| 46255 | TOYOTA 3SFE | 4 | 86.00 | 279 | 85 |
| 46256 | TOYOTA 3L | 4 | 96.00 | 307 | 197 |
| 46257 | TOYOTA 1HZ, 1PZ | 6 | 94.00 | 303 | 183 |
| 46258 | TOYOTA 5E-FE | 4 | 74.00 | 261 | 14 |
| 46259 | TOYOTA 7K | 4 | 80.50 | 269 | 47 |
| 46260 | TOYOTA 2C | 4 | 86.00 | 296 | 154 |
| 46261 | TOYOTA 2L-II, 2L LATE | 4 | 92.00 | 301 | 175 |
| 46262 | TOYOTA 4AFE, 4AG | 4 | 81.00 | 270 | 52 |
| 46263 | TOYOTA 3SGTE | 4 | 86.00 | 281 | 93 |
| 46264 | TOYOTA 2C-II, 2CT LATE | 4 | 86.00 | 296 | 155 |
| 46265 | TOYOTA BU 15-II | 4 | 95.00 | 305 | 189 |
| 46266 | TOYOTA 4AFE-II, 4AG | 4 | 81.00 | 271 | 53 |
| 46267 | TOYOTA 21R-II | 4 | 84.00 | 275 | 69 |
| 46268 | TOYOTA 1HD-T LATE | 6 | 94.00 | 303 | 181 |
| 46269 | TOYOTA 4AC/ 4AELU | 4 | 81.00 | 270 | 51 |
| 46270 | TOYOTA 1FZ-FE | 6 | 100.00 | 292 | 138 |
| 46271 | TOYOTA 4AFE-III | 4 | 81.00 | 271 | 54 |
| 46272 | TOYOTA 3F NEW, 3FE | 6 | 94.00 | 289 | 126 |
| 46273 | TOYOTA 5L | 4 | 99.50 | 308 | 201 |
| 46274 | TOYOTA 3E, 3EE | 4 | 73.00 | 260 | 12 |
| 46275 | TOYOTA 7MGTE, 7MGTEU | 6 | 83.00 | 274 | 67 |
| 46276 | TOYOTA 1N | 4 | 74.00 | 293 | 142 |
| 46277 | TOYOTA 7AFE | 4 | 81.00 | 272 | 60 |
| 46278 | TOYOTA 2C-T | 4 | 86.00 | 297 | 158 |
| 46279 | TOYOTA 5SFE | 4 | 87.00 | 282 | 98 |
| 46280 | TOYOTA 7MGE, 7MG | 6 | 83.00 | 274 | 66 |
| 46281 | TOYOTA 3VZ-FE | 6 | 87.50 | 283 | 104 |
| 46282 | TOYOTA 1FZ-FE-II | 6 | 100.00 | 292 | 139 |
| 46283 | TOYOTA 1KZ-TE, 1KZ | 4 | 96.00 | 306 | 195 |
| 46286 | TOYOTA 4 A-GEU | 4 | 81.00 | 270 | 49 |
| 46287 | TOYOTA 11B | 4 | 95.00 | 303 | 184 |
| 46288 | TOYOTA 1MZFE | 6 | 87.50 | 282 | 100 |
| 46289 | TOYOTA 4SFI | 4 | 82.50 | 273 | 62 |
| 46290 | TOYOTA 5AF | 4 | 78.70 | 266 | 34 |
| 46294 | TOYOTA 20R | 4 | 88.50 | 285 | 110 |
| 46300 | TOYOTA 1RZ | 4 | 86.00 | 277 | 80 |
| 46308 | TOYOTA BU-30-II | 4 | 95.00 | 305 | 190 |
| 46309 | TOYOTA 5SFE-II | 4 | 87.00 | 282 | 99 |
| 46310 | TOYOTA 4AGE, 4AGELC | 4 | 81.00 | 271 | 56 |
| 46311 | TOYOTA 2RZ-FE | 4 | 95.00 | 290 | 130 |



NUMERICAL INDEX

| TEIKIN NO | ENGINE MODEL | Cyl. | BORE Ø (mm) | PAGE | BOX NO. | |
|-----------|--------------|----------------|-------------|--------|---------|-----|
| 46312 | TOYOTA | 3RZ-FE, 3RZ-FZ | 4 | 95.00 | 292 | 137 |
| 46313 | TOYOTA | 2TZ-FE | 4 | 95.00 | 291 | 133 |
| 46316 | TOYOTA | H-II | 6 | 88.00 | 299 | 166 |
| 46325 | TOYOTA | 1HD-T-II | 6 | 94.00 | 303 | 182 |
| 46329 | TOYOTA | 2TZFZE | 4 | 95.00 | 291 | 135 |
| 46330 | TOYOTA | 2JZGE | 6 | 86.00 | 281 | 95 |
| 46331G | TOYOTA | 2JZGTE | 6 | 86.00 | 282 | 97 |
| 46332 | TOYOTA | 1NZFE | 4 | 75.00 | 261 | 15 |
| 46334 | TOYOTA | 1ZZFE | 4 | 79.00 | 266 | 36 |
| 46335 | TOYOTA | 5K-II | 4 | 80.50 | 269 | 46 |
| 46336 | TOYOTA | 4A | 4 | 81.00 | 270 | 50 |
| 46337 | TOYOTA | 2UZFE | 8 | 94.00 | 289 | 127 |
| 46338 | TOYOTA | 2T/2TB | 4 | 85.00 | 276 | 75 |
| 46339 | TOYOTA | RINO | 4 | 104.00 | 309 | 208 |
| 46340 | TOYOTA | 2ZZFE | 4 | 82.00 | 273 | 61 |
| 46341 | TOYOTA | 1SZFE | 4 | 69.00 | 258 | 1 |
| 46342 | TOYOTA | 4ZZFE | 4 | 79.00 | 267 | 38 |
| 46343 | TOYOTA | 2AZFE | 4 | 88.50 | 285 | 112 |
| 46344 | TOYOTA | 2TZ-FE-II | 4 | 95.00 | 291 | 134 |
| 46345 | TOYOTA | 2E-II | 4 | 73.00 | 260 | 11 |
| 46346 | TOYOTA | 4E-FE-II | 4 | 74.00 | 261 | 13 |
| 46347 | TOYOTA | 5AFE NEW | 4 | 78.70 | 266 | 35 |
| 46348AG | TOYOTA | 2KD - FTV | 4 | 92.00 | 301 | 173 |
| 46349 | TOYOTA | 4A-GEU-II | 4 | 81.00 | 272 | 59 |
| 46350 | TOYOTA | 1UZFE-II | 8 | 87.50 | 284 | 106 |
| 46351A | TOYOTA | 2LT NEW-II | 4 | 92.00 | 302 | 177 |
| 46352 | TOYOTA | 2JZGE-II | 6 | 86.00 | 281 | 96 |
| 46353 | TOYOTA | 1AZFE | 4 | 86.00 | 277 | 78 |
| 46354 | TOYOTA | 2NZ-FE | 4 | 75.00 | 262 | 19 |
| 46355 | TOYOTA | 2NZ-FE-II | 4 | 75.00 | 262 | 20 |
| 46356 | TOYOTA | 3SZ-VE | 4 | 72.00 | 259 | 7 |
| 46357 | TOYOTA | 3MZFE | 6 | 92.00 | 287 | 119 |
| 46358 | TOYOTA | 7K-II | 4 | 80.50 | 269 | 48 |
| 46359 | TOYOTA | 1RZ-III | 4 | 86.00 | 278 | 81 |
| 46360 | TOYOTA | 2TR-FE | 4 | 95.00 | 290 | 132 |
| 46361 | TOYOTA | K3-VE | 4 | 72.00 | 259 | 8 |
| 46362AG | TOYOTA | 1HD-FT | 6 | 94.00 | 302 | 179 |
| 46363 | TOYOTA | 2GR-FE | 6 | 94.00 | 288 | 124 |
| 46364 | TOYOTA | 1NZFE-II | 4 | 75.00 | 261 | 16 |
| 46365 | TOYOTA | 1AZ-FSE | 4 | 86.00 | 277 | 79 |

NUMERICAL INDEX

| TEIKIN NO | ENGINE MODEL | Cyl. | BORE Ø (mm) | PAGE | BOX NO. |
|-----------|----------------------------|------|-------------|------|---------|
| 46366 | TOYOTA 1TR-FE | 4 | 86.00 | 278 | 82 |
| 46367 | TOYOTA 3ZZ-FE | 4 | 79.00 | 267 | 37 |
| 46368 | TOYOTA 1GR-FE | 6 | 94.00 | 288 | 121 |
| 46369 | TOYOTA 2J-III | 4 | 88.00 | 298 | 164 |
| 46370 | TOYOTA 1NZ-FXE | 4 | 75.00 | 262 | 18 |
| 46371 | TOYOTA 1NZFE-III | 4 | 75.00 | 262 | 17 |
| 46372 | TOYOTA 1FZ-FE-III | 6 | 100.00 | 292 | 140 |
| 46373 | TOYOTA 3SFE-VII | 4 | 86.00 | 280 | 89 |
| 46374 | TOYOTA 2C-IV | 4 | 86.00 | 297 | 157 |
| 46375 | TOYOTA 2RZ-FE-III | 4 | 95.00 | 290 | 131 |
| 46376 | TOYOTA 4SF-II | 4 | 82.50 | 273 | 63 |
| 46377 | TOYOTA 1G-FE | 6 | 75.00 | 264 | 25 |
| 46378 | TOYOTA 3S-FSE | 4 | 86.00 | 280 | 90 |
| 46379 | TOYOTA 2AZFE-II | 4 | 88.50 | 286 | 113 |
| 46381A | TOYOTA S05C-II | 4 | 114.00 | 311 | 213 |
| 46382 | TOYOTA 1ZR-FE | 4 | 80.50 | 268 | 41 |
| 46383 | TOYOTA 2ZR-FE | 4 | 80.50 | 268 | 42 |
| 46384 | TOYOTA 3ZR-FE | 4 | 80.50 | 268 | 43 |
| 46385 | TOYOTA 1SZFE-II | 4 | 69.00 | 258 | 2 |
| 46386 | TOYOTA 3GR-FE | 6 | 87.50 | 283 | 102 |
| 46387 | TOYOTA 3NR-FE | 4 | 72.50 | 260 | 9 |
| 46388 | TOYOTA 3UR-FE | 8 | 94.00 | 289 | 128 |
| 46600 | TOYOTA 2LT LATE | 4 | 92.00 | 301 | 176 |
| 46601 | TOYOTA 2C-III | 4 | 86.00 | 296 | 156 |
| 46602 | TOYOTA 2L-T, 2L-THE, 2L-TE | 4 | 92.00 | 302 | 178 |
| 46603 | TOYOTA 2K | 4 | 72.00 | 259 | 5 |
| 46604 | TOYOTA 2A | 4 | 76.00 | 264 | 26 |
| 46605 | TOYOTA 5M | 6 | 83.00 | 273 | 64 |
| 46606 | TOYOTA 3VZE | 6 | 87.50 | 283 | 103 |
| 46607 | TOYOTA 2RZ, 2RZE | 4 | 95.00 | 290 | 129 |
| 46608 | TOYOTA 11B-II | 4 | 95.00 | 304 | 185 |
| 46609 | TOYOTA 2CT-II | 4 | 86.00 | 297 | 159 |
| 46610 | TOYOTA 1GE | 6 | 75.00 | 263 | 23 |
| 46611 | TOYOTA 2H LATE | 6 | 91.00 | 300 | 172 |
| 46612 | TOYOTA 4P(High) | 4 | 76.60 | 265 | 29 |
| 46613 | TOYOTA 1Z | 4 | 96.00 | 306 | 196 |
| 46614 | TOYOTA 2R | 4 | 78.00 | 266 | 33 |
| 46615 | TOYOTA 3P | 4 | 76.60 | 264 | 28 |
| 46618 | TOYOTA 4AGE | 4 | 81.00 | 271 | 55 |
| 46619 | TOYOTA 2TC | 4 | 85.00 | 276 | 76 |

NUMERICAL INDEX

| TEIKIN NO | ENGINE MODEL | Cyl. | BORE Ø (mm) | PAGE | BOX NO. |
|-----------|---------------------|------|-------------|------|---------|
| 46620 | TOYOTA 3SFE-II | 4 | 86.00 | 279 | 86 |
| 46621 | TOYOTA 3SFE-III | 4 | 86.00 | 279 | 87 |
| 46622 | TOYOTA 3B-II | 4 | 102.00 | 309 | 207 |
| 46623 | TOYOTA 2F-II | 6 | 94.00 | 288 | 123 |
| 46624 | TOYOTA 12H-T | 6 | 91.00 | 300 | 170 |
| 46625 | TOYOTA 14B-T | 4 | 102.00 | 309 | 205 |
| 46626 | TOYOTA B LATE | 4 | 95.00 | 304 | 186 |
| 46627 | TOYOTA 2S | 4 | 84.00 | 275 | 71 |
| 46629A | TOYOTA 3C | 4 | 86.00 | 298 | 161 |
| 46630 | TOYOTA 1C-III | 4 | 83.00 | 294 | 148 |
| 46632 | TOYOTA 5MGEU | 6 | 83.00 | 274 | 65 |
| 46650 | TOYOTA 1C-II | 4 | 83.00 | 294 | 147 |
| 46651 | TOYOTA 4P(Low) | 4 | 76.60 | 265 | 30 |
| 46653 | TOYOTA 21R-III | 4 | 84.00 | 275 | 70 |
| 46654A | TOYOTA 1DZ | 4 | 86.00 | 295 | 150 |
| 46655A | TOYOTA 15BF | 4 | 108.00 | 310 | 211 |
| 46656AG | TOYOTA 15BF-T | 4 | 108.00 | 310 | 212 |
| 46658 | TOYOTA 1A | 4 | 77.50 | 265 | 31 |
| 46659 | TOYOTA 20R-II | 4 | 88.50 | 285 | 111 |
| 46660 | TOYOTA 2VZ-FE | 6 | 87.50 | 283 | 101 |
| 46661 | TOYOTA 1E, 1EL | 4 | 70.50 | 258 | 3 |
| 46662 | TOYOTA 13T | 4 | 85.00 | 275 | 72 |
| 46663 | TOYOTA 3SGE | 4 | 86.00 | 280 | 91 |
| 46664 | TOYOTA 4A-GEU - VVT | 4 | 81.00 | 272 | 58 |
| 46665 | TOYOTA 1UZFE | 8 | 87.50 | 284 | 105 |
| 46666 | TOYOTA 5VZ-FE | 6 | 93.50 | 287 | 120 |
| 46667 | TOYOTA 3SFE-IV | 4 | 86.00 | 279 | 88 |
| 46668A | TOYOTA 13B-T | 4 | 102.00 | 308 | 203 |
| 46670 | TOYOTA 1G-EU | 6 | 75.00 | 263 | 24 |
| 46671AG | TOYOTA 1KZ-TE NEW | 4 | 96.00 | 306 | 194 |
| 46674AG | TOYOTA 1HD-FTE | 6 | 94.00 | 302 | 180 |
| 46675AG | TOYOTA 1KD-FTV | 4 | 96.00 | 305 | 191 |
| 46676AG | TOYOTA 1ND-TV | 4 | 73.00 | 293 | 141 |
| 46677 | TOYOTA 1KR-FE | 3 | 71.00 | 258 | 4 |
| 46678AG | TOYOTA 1AD-FTV | 4 | 86.00 | 295 | 149 |
| 46679AG | TOYOTA 2AD-FHV | 4 | 86.00 | 295 | 152 |
| 46680AG | TOYOTA 1CD-FTV | 4 | 82.20 | 293 | 143 |
| 46682 | TOYOTA 2Z NEW | 4 | 98.00 | 307 | 199 |
| 46683 | TOYOTA 2SZ-FE | 4 | 72.00 | 259 | 6 |
| 46684 | TOYOTA 1DZ NEW | 4 | 86.00 | 295 | 151 |

NUMERICAL INDEX

| TEIKIN NO | ENGINE MODEL | | Cyl. | BORE Ø (mm) | PAGE | BOX NO. |
|-----------|--------------|-----------------------|------|-------------|------|---------|
| 46685 | TOYOTA | 13Z | 6 | 98.00 | 307 | 200 |
| 46686AG | TOYOTA | 1KD-FTV-II | 4 | 96.00 | 305 | 192 |
| 46687 | TOYOTA | 2A-II | 4 | 76.00 | 264 | 27 |
| 46688 | TOYOTA | 3ZR-FE-II | 4 | 80.50 | 268 | 44 |
| 46689 | TOYOTA | 3SGE-II | 4 | 86.00 | 280 | 92 |
| 46690AG | TOYOTA | 1CD-FTV-II | 4 | 82.20 | 293 | 144 |
| 46691AG | TOYOTA | 1VD-FTV | 8 | 86.00 | 298 | 162 |
| 46692 | TOYOTA | 1C NEW | 4 | 83.00 | 294 | 146 |
| 46694 | TOYOTA | 3RZ-F | 4 | 95.00 | 291 | 136 |
| 46695AG | TOYOTA | 2CT-III | 4 | 86.00 | 297 | 160 |
| 46696AG | TOYOTA | 2AD-FTV | 4 | 86.00 | 296 | 153 |
| 46697 | TOYOTA | 1AR-FE | 4 | 90.00 | 286 | 114 |
| 46698AG | TOYOTA | 1KD-FTV-III | 4 | 96.00 | 306 | 193 |
| | | | | | | |
| 47101 | JEEP WILLYS | 88 ANP | 4 | 79.38 | 108 | 1 |
| 47102 | JEEP WILLYS | 488 ANP | 4 | 79.38 | 108 | 2 |
| | | | | | | |
| 48101A | VOLKSWAGEN | ME, JP, JK, DW, CS | 4 | 76.50 | 321 | 31 |
| 48102 | VOLKSWAGEN | FR/JB, FP WV | 4 | 79.50 | 315 | 11 |
| 48107 | VOLKSWAGEN | ET/ZF/EP 1981 -ON | 4 | 75.00 | 314 | 7 |
| 48108 | VOLKSWAGEN | 1600-HIGH, 311 | 4 | 85.50 | 320 | 29 |
| 48109 | VOLKSWAGEN | 1600-LOW, AM | 4 | 85.50 | 320 | 30 |
| 48110 | VOLKSWAGEN | E-II, ABS KAT, DS, DX | 4 | 81.00 | 316 | 16 |
| 48111 | VOLKSWAGEN | 9A, 9A 4V KAT | 4 | 82.50 | 318 | 21 |
| 48112 | VOLKSWAGEN | DJ | 4 | 94.00 | 322 | 35 |
| 48113 | VOLKSWAGEN | ABA | 4 | 82.50 | 318 | 22 |
| 48201 | VOLKSWAGEN | JS KAT | 4 | 81.00 | 317 | 17 |
| 48203 | VOLKSWAGEN | AEG | 4 | 82.50 | 318 | 24 |
| 48204 | VOLKSWAGEN | AEB | 4 | 81.00 | 316 | 14 |
| 48205 | VOLKSWAGEN | AEB-II | 4 | 81.00 | 316 | 15 |
| 48206 | VOLKSWAGEN | 2.5 / 2.6 MICROBUS | 5 | 82.50 | 319 | 25 |
| 48207 | VOLKSWAGEN | ABA-II | 4 | 82.50 | 318 | 23 |
| 48208 | VOLKSWAGEN | BGP/BGQ | 5 | 82.50 | 319 | 28 |
| 48209 | VOLKSWAGEN | LUPO | 4 | 76.50 | 315 | 10 |
| 48210 | VOLKSWAGEN | EA111 RSH | 4 | 67.11 | 313 | 3 |
| 48211 | VOLKSWAGEN | EA111 | 4 | 67.11 | 313 | 1 |
| 48212 | VOLKSWAGEN | EA111 ALCOOL | 4 | 67.11 | 313 | 2 |
| 48213 | VOLKSWAGEN | EA111-II | 4 | 67.11 | 314 | 5 |
| 48214 | VOLKSWAGEN | EA111 RSH-II | 4 | 67.11 | 313 | 4 |
| 48215 | VOLKSWAGEN | 2.0 L LATE | 4 | 82.50 | 317 | 20 |

NUMERICAL INDEX

| TEIKIN NO | ENGINE MODEL | | Cyl. | BORE Ø (mm) | PAGE | BOX NO. |
|-----------|--------------|-----------------------|------|-------------|------|---------|
| 48600 | VOLKSWAGEN | PL 4 KAT | 4 | 81.00 | 317 | 18 |
| 48601A | VOLKSWAGEN | 1G / 1V / CY TURBO | 4 | 76.50 | 321 | 32 |
| 48602A | VOLKSWAGEN | 1X / 1Y / AAB | 4 | 79.50 | 321 | 33 |
| 48603A | VOLKSWAGEN | AAZ / ABL / ADE TURBO | 4 | 79.50 | 321 | 34 |
| 48604 | VOLKSWAGEN | 1F / ABN / DT / EW | 4 | 81.00 | 315 | 12 |
| 48605 | VOLKSWAGEN | 2G / AAV / HK | 4 | 75.00 | 314 | 6 |
| 48606 | VOLKSWAGEN | ADP / AEK / AFT | 4 | 81.01 | 316 | 13 |
| 48607 | VOLKSWAGEN | AEA / AEE / AHS / ALM | 4 | 76.50 | 314 | 8 |
| 48608 | VOLKSWAGEN | AFH / AFK / AHW | 4 | 76.50 | 315 | 9 |
| 48609 | VOLKSWAGEN | AAM/ADF/DS/EX/RP | 4 | 81.01 | 317 | 19 |
| 48610 | VOLKSWAGEN | 2E,ADY,AGG | 4 | 82.50 | 319 | 26 |
| 48611A | VOLKSWAGEN | BPY / CBFA / CCTA | 4 | 82.50 | 319 | 27 |
| | | | | | | |
| 49101 | DAEWOO | LE MANS 1.5 | 4 | 76.50 | 15 | 4 |
| 49102 | DAEWOO | NUBIRA | 4 | 79.00 | 16 | 6 |
| 49103 | DAEWOO | CIELO 1.5 | 4 | 76.50 | 15 | 3 |
| 49104 | DAEWOO | F8C | 3 | 68.50 | 15 | 1 |
| 49105 | DAEWOO | NUBIRA-II | 4 | 76.50 | 16 | 5 |
| 49106 | DAEWOO | MATIZ II | 4 | 68.50 | 15 | 2 |
| | | | | | | |
| 50101 | LEYLAND | 4.98 NV | 4 | 98.00 | 118 | 1 |
| | | | | | | |
| 51101 | HYUNDAI | J2 (BETA) | 4 | 77.40 | 71 | 16 |
| 51102 | HYUNDAI | D4BB | 4 | 91.10 | 78 | 43 |
| 51103 | HYUNDAI | D4AF | 4 | 104.00 | 79 | 46 |
| 51104 | HYUNDAI | G4EK - ALPHA - F1 | 4 | 75.50 | 70 | 10 |
| 51105 | HYUNDAI | G4DR - BETA - J2 | 4 | 82.00 | 73 | 21 |
| 51108 | HYUNDAI | D4BA | 4 | 91.10 | 78 | 42 |
| 51110 | HYUNDAI | G6BV | 4 | 86.50 | 74 | 28 |
| 51111 | HYUNDAI | G6BV DELTA | 6 | 84.00 | 74 | 25 |
| 51112 | HYUNDAI | D4AE | 4 | 100.00 | 79 | 45 |
| 51113 | HYUNDAI | G6BA | 6 | 86.70 | 75 | 30 |
| 51114 | HYUNDAI | G4DM | 4 | 81.50 | 72 | 19 |
| 51115 | HYUNDAI | 1.6L | 4 | 76.50 | 70 | 12 |
| 51116 | HYUNDAI | G4FK | 4 | 75.50 | 70 | 11 |
| 51117 | HYUNDAI | ATOZ | 4 | 66.00 | 68 | 2 |
| 51118 | HYUNDAI | ATOZ-II | 4 | 63.00 | 68 | 1 |
| 51119 | HYUNDAI | G4EB | 4 | 75.50 | 70 | 9 |
| 51120 | HYUNDAI | G4DR - BETA - J2 - II | 4 | 82.00 | 73 | 22 |
| 51121 | HYUNDAI | XD | 4 | 76.50 | 71 | 13 |

NUMERICAL INDEX

| TEIKIN NO | ENGINE MODEL | | Cyl. | BORE Ø (mm) | PAGE | BOX NO. |
|-----------|--------------|-----------------|------|-------------|------|---------|
| 51122 | HYUNDAI | MATRIX 1.8L | 4 | 82.00 | 73 | 24 |
| 51123 | HYUNDAI | XG350 | 6 | 93.00 | 76 | 35 |
| 51124 | HYUNDAI | DELTA 2.7L | 6 | 86.70 | 75 | 29 |
| 51125 | HYUNDAI | Y2 | 4 | 80.60 | 72 | 18 |
| 51127 | HYUNDAI | 2.0L | 4 | 82.00 | 72 | 20 |
| 51128 | HYUNDAI | ATTITUDE | 4 | 75.50 | 69 | 8 |
| 51129 | HYUNDAI | X3-II | 4 | 71.50 | 69 | 6 |
| 51130 | HYUNDAI | G4JP | 4 | 85.00 | 74 | 26 |
| 51131 | HYUNDAI | G4GF | 4 | 82.00 | 73 | 23 |
| 51132 | HYUNDAI | SONATA 3.8L | 6 | 96.00 | 76 | 36 |
| 51133 | HYUNDAI | SONATA 3.3L | 6 | 92.00 | 76 | 34 |
| 51134 | HYUNDAI | ACCENT 1.5L | 4 | 75.50 | 69 | 7 |
| 51135 | HYUNDAI | SONATA 2.4L | 4 | 88.00 | 75 | 32 |
| 51136 | HYUNDAI | AVANTE 1.6L | 4 | 77.00 | 71 | 14 |
| 51137 | HYUNDAI | 15D | 4 | 79.70 | 72 | 17 |
| 51138 | HYUNDAI | SANTA FE | 6 | 86.70 | 75 | 31 |
| 51139 | HYUNDAI | G6DB | 6 | 92.00 | 76 | 33 |
| 51140 | HYUNDAI | KAPPA2 | 4 | 71.00 | 68 | 4 |
| 51141 | HYUNDAI | SANTRO XING 1.1 | 4 | 66.00 | 68 | 3 |
| 51142AG | HYUNDAI | i20 MAGNA CDRI | 4 | 75.00 | 77 | 37 |
| 51144 | HYUNDAI | G4KD | 4 | 86.00 | 74 | 27 |
| 51145 | HYUNDAI | G4FC-II | 4 | 77.00 | 71 | 15 |
| 51600 | HYUNDAI | X3, G4EH | 4 | 71.50 | 69 | 5 |
| 51602AG | HYUNDAI | D4DA | 4 | 104.00 | 79 | 48 |
| 51603AG | HYUNDAI | D4CB CRDI | 4 | 91.00 | 78 | 41 |
| 51604A | HYUNDAI | D3EA | 3 | 83.00 | 77 | 38 |
| 51604A-4 | HYUNDAI | D4EA | 4 | 83.00 | 77 | 39 |
| 51605AG | HYUNDAI | D4EB-F/D4EB-G | 4 | 87.00 | 77 | 40 |
| 51606AG | HYUNDAI | D4BH | 4 | 91.10 | 78 | 44 |
| 51607A | HYUNDAI | D4AF-III | 4 | 104.00 | 79 | 47 |
| 52101 | KIA | FE | 4 | 86.00 | 111 | 11 |
| 52102 | KIA | DC | 4 | 75.50 | 109 | 4 |
| 52103 | KIA | B6D | 4 | 78.00 | 110 | 5 |
| 52105 | KIA | CARNIVAL | 6 | 80.00 | 110 | 8 |
| 52106 | KIA | PICANTO | 4 | 67.00 | 109 | 1 |
| 52107AG | KIA | CARNIVAL-II | 4 | 97.10 | 112 | 13 |
| 52108 | KIA | CREDOS | 4 | 81.00 | 111 | 9 |
| 52110 | KIA | B1 | 4 | 68.00 | 109 | 2 |
| 52111 | KIA | RIO 1.6L | 4 | 78.00 | 110 | 6 |

NUMERICAL INDEX

| TEIKIN NO | ENGINE MODEL | | Cyl. | BORE Ø (mm) | PAGE | BOX NO. |
|-----------|--------------|---------------------|------|-------------|------|---------|
| 52112 | KIA | SPECTRA | 4 | 81.00 | 111 | 10 |
| 52113 | KIA | SEPHIA-II | 4 | 78.00 | 110 | 7 |
| 52650A | KIA | RFA | 4 | 93.00 | 112 | 12 |
| 52651A | KIA | JT 3.0 | 4 | 98.00 | 112 | 14 |
| 52652A | KIA | JD K3500 | 4 | 100.00 | 112 | 15 |
| 52653G | KIA | SH K3600 | 4 | 100.00 | 113 | 16 |
| 52654 | KIA | A3E | 4 | 75.50 | 109 | 3 |
| 52656G | KIA | SH K3600 NEW-II | 4 | 100.00 | 113 | 17 |
| 53101 | ASIA | TOWNER | 3 | 70.00 | 03 | 1 |
| 54101 | BMW | M 20 B 20 L | 6 | 80.00 | 06 | 1 |
| 54102 | BMW | M 20 B 25 M1 Z7 KAT | 6 | 84.00 | 06 | 2 |
| 55101 | SUBARU | EJ22, EJ22E | 4 | 96.90 | 242 | 10 |
| 55102 | SUBARU | EJ20-T | 4 | 92.00 | 241 | 8 |
| 55103 | SUBARU | EJ25 | 4 | 99.50 | 242 | 11 |
| 55104 | SUBARU | EJ25-II | 4 | 99.50 | 243 | 14 |
| 55105 | SUBARU | EJ255-T | 4 | 99.50 | 242 | 12 |
| 55106 | SUBARU | EZ30D | 6 | 89.20 | 240 | 3 |
| 55107 | SUBARU | EZ30D-II | 6 | 89.20 | 240 | 4 |
| 55108 | SUBARU | EJ255-II | 4 | 99.50 | 243 | 15 |
| 55109 | SUBARU | EJ255-III | 4 | 99.50 | 243 | 13 |
| 55650 | SUBARU | EF10 | 3 | 78.00 | 240 | 1 |
| 55651 | SUBARU | EA71 | 4 | 92.00 | 241 | 5 |
| 55652 | SUBARU | EF12 | 3 | 78.00 | 240 | 2 |
| 55653 | SUBARU | EA82 | 4 | 92.00 | 241 | 6 |
| 55654 | SUBARU | EJ20 | 4 | 92.00 | 241 | 7 |
| 55655 | SUBARU | EJ20-T-II | 4 | 92.00 | 242 | 9 |
| 56101 | OPEL | 1300S, 13S | 4 | 75.00 | 231 | 2 |
| 56102 | OPEL | 1.6 SE | 4 | 79.00 | 232 | 6 |
| 56103 | OPEL | 1.6 SV, 16 SV KAT | 4 | 79.00 | 232 | 7 |
| 56104 | OPEL | 1800 | 4 | 84.80 | 233 | 10 |
| 56105 | OPEL | 20E CIH, 20S | 4 | 95.00 | 235 | 17 |
| 56105-6 | OPEL | 3.0 E/NE | 6 | 95.00 | 235 | 18 |
| 56106 | OPEL | 1.3 NE | 4 | 75.00 | 231 | 1 |
| 56107 | OPEL | C20XE4V KAT | 4 | 86.00 | 234 | 14 |
| 56108 | OPEL | 2.0 X | 4 | 86.00 | 233 | 11 |
| 56109 | OPEL | 1.6 LZ | 4 | 79.00 | 232 | 5 |

NUMERICAL INDEX

| TEIKIN NO | ENGINE MODEL | | Cyl. | BORE Ø (mm) | PAGE | BOX NO. |
|-----------|----------------|-------------------|------|-------------|------|---------|
| 56110 | OPEL | Z 1.4 XE | 4 | 77.60 | 231 | 4 |
| 56111 | OPEL | Z 22 SE | 4 | 86.00 | 234 | 16 |
| 56112 | OPEL | C20NE KAT | 4 | 86.00 | 234 | 13 |
| 56113 | OPEL | X18XE | 4 | 80.50 | 233 | 9 |
| 56600 | OPEL | 14 NV, 14 NVH | 4 | 77.60 | 231 | 3 |
| 56601 | OPEL | 20 SE, X20 SE KAT | 4 | 86.00 | 233 | 12 |
| 56603 | OPEL | X 1.6 XE / XEL | 4 | 79.00 | 232 | 8 |
| 56604 | OPEL | C 2.0 XEV | 4 | 86.00 | 234 | 15 |
| 56605A | OPEL | Y 13 DT/Z 13 DT | 4 | 69.60 | 236 | 19 |
| 56606A | OPEL | Y 17 DT/DTL | 4 | 79.00 | 236 | 20 |
| 57101 | ACURA | C35A1 | 6 | 90.00 | 01 | 1 |
| 58101 | GENERAL MOTORS | MOT.146 | 4 | 90.00 | 38 | 9 |
| 58102 | GENERAL MOTORS | L61 | 4 | 86.00 | 37 | 6 |
| 58103 | GENERAL MOTORS | ASTRA | 4 | 87.50 | 37 | 7 |
| 58104 | GENERAL MOTORS | CORSA MPFI | 4 | 71.10 | 36 | 2 |
| 58105 | GENERAL MOTORS | CORSA EFI | 4 | 71.10 | 36 | 1 |
| 58106 | GENERAL MOTORS | HCV | 4 | 71.10 | 36 | 3 |
| 58107 | GENERAL MOTORS | HCV FLEX | 4 | 71.10 | 36 | 4 |
| 58108 | GENERAL MOTORS | 191 | 6 | 89.00 | 37 | 8 |
| 58109 | GENERAL MOTORS | 213/LX9 | 6 | 94.00 | 38 | 10 |
| 58110 | GENERAL MOTORS | B207R | 4 | 86.00 | 37 | 5 |
| 58111 | GENERAL MOTORS | LLV | 4 | 95.50 | 38 | 11 |
| 58111-5 | GENERAL MOTORS | LLR | 5 | 95.50 | 38 | 12 |
| 59101 | LADA | 2101 | 4 | 76.00 | 115 | 1 |
| 59103 | LADA | 21011 | 4 | 79.00 | 115 | 2 |
| 59105 | LADA | 21083 | 4 | 82.00 | 116 | 5 |
| 59106 | LADA | 2110 | 4 | 82.00 | 115 | 4 |
| 59107 | LADA | VAZ 2112 | 4 | 82.00 | 116 | 7 |
| 59108 | LADA | 21213 | 4 | 82.00 | 116 | 6 |
| 59109 | LADA | VAZ 2105 | 4 | 79.00 | 115 | 3 |
| 60102 | VOLGA | GAZ 4062.10 | 4 | 92.00 | 312 | 1 |
| 60103 | VOLGA | 405 | 4 | 95.55 | 312 | 2 |
| 61601 | AUDI | AAR / NF / NG | 5 | 82.50 | 04 | 1 |
| 62101A-2 | TATA | ACE | 2 | 75.00 | 255 | 1 |



NUMERICAL INDEX

| TEIKIN NO | ENGINE MODEL | | Cyl. | BORE Ø (mm) | PAGE | BOX NO. |
|-----------|---------------|-------------|------|-------------|------|---------|
| 62101A | TATA | INDICA | 4 | 75.00 | 255 | 3 |
| 62102A | TATA | 407 TURBO | 4 | 97.00 | 256 | 5 |
| 62103A | TATA | 207 | 4 | 83.00 | 255 | 4 |
| 62104A-2 | TATA | ACE-II | 2 | 75.00 | 255 | 2 |
| 63101A | ASHOK LEYLAND | 6ETI | 6 | 104.00 | 02 | 2 |
| 63102A | ASHOK LEYLAND | 6DTI | 6 | 104.00 | 02 | 1 |
| 64601 | KOMATSU | 4D95 | 4 | 95.00 | 114 | 1 |
| 64602A | KOMATSU | 4D105 | 4 | 105.00 | 114 | 2 |
| 65001A | EICHER CANTER | 4D31 | 4 | 100.00 | 23 | 1 |
| 65002A | EICHER CANTER | 483 TC | 4 | 100.00 | 23 | 2 |
| 66101A | MAHINDRA | SCORPIO CRD | 4 | 94.00 | 119 | 1 |
| 67101 | PEUGEOT | 2031 70 | 4 | 75.00 | 238 | 1 |
| 67102 | PEUGEOT | 2297 50 | 4 | 83.00 | 238 | 2 |
| 67103 | PEUGEOT | 2300 90 | 4 | 88.00 | 238 | 3 |
| 68101A | TEMPO | TRAVELLER | 4 | 90.90 | 257 | 1 |
| G0101 | KUBOTA | KND3B | 1 | 68.00 | 326 | 1 |
| G0102 | KUBOTA | KND 5B | 1 | 80.00 | 327 | 7 |
| G0103 | KUBOTA | KND 70A | 1 | 78.00 | 327 | 6 |
| G0104 | KUBOTA | KND 80 | 1 | 84.00 | 328 | 11 |
| G0105 | KUBOTA | KND 90/120 | 1 | 95.00 | 330 | 20 |
| G0106 | KUBOTA | KND 85 | 1 | 84.00 | 328 | 12 |
| G0107 | KUBOTA | KND 105 | 1 | 92.00 | 330 | 17 |
| G0108 | KUBOTA | KND 110 | 1 | 92.00 | 330 | 18 |
| G0109 | KUBOTA | KND 180 | 1 | 110.00 | 331 | 21 |
| G0110 | KUBOTA | KND 190 | 1 | 110.00 | 331 | 22 |
| G0111 | KUBOTA | RD 65 | 1 | 80.00 | 327 | 8 |
| G0112 | KUBOTA | JD75 | 1 | 78.00 | 327 | 5 |
| G0113 | KUBOTA | GA80 | 1 | 82.00 | 328 | 9 |
| G0114 | KUBOTA | GA 90 | 1 | 90.00 | 329 | 16 |
| G0115 | KUBOTA | KND 220 | 1 | 116.00 | 331 | 23 |
| G0116 | KUBOTA | KND40 | 1 | 75.00 | 326 | 3 |
| G0117 | KUBOTA | KND 250 | 1 | 118.00 | 331 | 24 |
| G0118 | KUBOTA | RD 85 | 1 | 86.00 | 329 | 14 |



NUMERICAL INDEX

| TEIKIN NO | ENGINE MODEL | | Cyl. | BORE Ø (mm) | PAGE | BOX NO. |
|-----------|--------------|-----------|------|-------------|------|---------|
| G0119 | KUBOTA | KND 95Di | 1 | 86.00 | 329 | 13 |
| G0120 | KUBOTA | GA70 | 1 | 75.00 | 326 | 2 |
| G0121 | KUBOTA | RD 75 | 1 | 82.00 | 328 | 10 |
| G0122 | KUBOTA | RD 105 | 1 | 92.00 | 330 | 19 |
| G0123 | KUBOTA | RD 55 | 1 | 76.00 | 326 | 4 |
| G0124 | KUBOTA | RD 85S | 1 | 88.00 | 329 | 15 |
| G1101 | YANMAR | TS 50 | 1 | 70.00 | 334 | 1 |
| G1102 | YANMAR | TS 60 | 1 | 75.00 | 334 | 4 |
| G1103 | YANMAR | TS 70 | 1 | 80.00 | 336 | 10 |
| G1104 | YANMAR | TS 105 | 1 | 85.00 | 337 | 13 |
| G1105 | YANMAR | TS 130 | 1 | 92.00 | 337 | 16 |
| G1106 | YANMAR | TS 155 | 1 | 95.00 | 338 | 19 |
| G1107 | YANMAR | TS 180 | 1 | 102.00 | 339 | 21 |
| G1108 | YANMAR | TS 190 | 1 | 109.90 | 339 | 23 |
| G1109 | YANMAR | TS 230 | 1 | 112.00 | 339 | 24 |
| G1110 | YANMAR | 2T | 1 | 95.00 | 338 | 17 |
| G1111 | YANMAR | TF 65 | 1 | 78.00 | 335 | 6 |
| G1112 | YANMAR | TF 75 | 1 | 80.00 | 336 | 9 |
| G1113 | YANMAR | TF 85 | 1 | 85.00 | 336 | 11 |
| G1114 | YANMAR | TF 105 | 1 | 88.00 | 337 | 15 |
| G1115 | YANMAR | TF 85-II | 1 | 85.00 | 336 | 12 |
| G1116 | YANMAR | TF 155 | 1 | 102.00 | 338 | 20 |
| G1117 | YANMAR | TF 300 | 1 | 125.00 | 340 | 25 |
| G1118 | YANMAR | TF 55 | 1 | 75.00 | 334 | 3 |
| G1119A | YANMAR | 3T | 1 | 95.00 | 338 | 18 |
| G1120 | YANMAR | TF 65-II | 1 | 78.00 | 335 | 7 |
| G1601 | YANMAR | TS 105-II | 1 | 85.00 | 337 | 14 |
| G1602 | YANMAR | TS 180-II | 1 | 102.00 | 339 | 22 |
| G1603 | YANMAR | TS 50-II | 1 | 70.00 | 334 | 2 |
| G1604 | YANMAR | TS 60-II | 1 | 75.00 | 335 | 5 |
| G1605 | YANMAR | TS 70-II | 1 | 79.90 | 335 | 8 |
| G2101 | MITSUBISHI | MN55 | 1 | 68.00 | 332 | 2 |
| G2102 | MITSUBISHI | MN 240 | 1 | 113.00 | 333 | 6 |
| G2103 | MITSUBISHI | MN 110 | 1 | 88.00 | 333 | 5 |
| G2104 | MITSUBISHI | NM75 | 1 | 78.00 | 332 | 3 |
| G2105 | MITSUBISHI | NM45 | 1 | 65.00 | 332 | 1 |
| G2106 | MITSUBISHI | NM90 | 1 | 80.00 | 332 | 4 |



NUMERICAL INDEX

| TEIKIN NO | ENGINE MODEL | | Cyl. | BORE Ø (mm) | PAGE | BOX NO. |
|-----------|--------------|---------------------|------|-------------|------|---------|
| G3101 | DONG FENG | 95MM 5R | 1 | 95.00 | 353 | 1 |
| G3104 | DONG FENG | 1100 MM | 1 | 100.00 | 353 | 3 |
| G3105 | DONG FENG | 95MM 4R | 1 | 95.00 | 353 | 2 |
| G3106 | DONG FENG | 1110 MM | 1 | 109.80 | 353 | 4 |
| G4101 | HONDA | G-200 | 1 | 67.00 | 354 | 5 |
| G5101 | ROBIN | EY-15 | 1 | 63.00 | 354 | 6 |
| G5102 | ROBIN | EY-20 | 1 | 67.00 | 354 | 7 |
| G6101 | STIHL | 58 MM 2R | 1 | 58.00 | 354 | 8 |
| G8101 | PERKINS | 6.354 | 6 | 98.43 | 237 | 2 |
| G8102 | PERKINS | 68322 (NEW) | 4 | 91.48 | 237 | 1 |
| G8103 | PERKINS | 4.248 | 4 | 101.05 | 237 | 4 |
| G8104 | PERKINS | 4.236, A 4.236 | 4 | 98.48 | 237 | 3 |
| G9102 | CUM | MC1 | 1 | 92.08 | 324 | 8 |
| G9106 | BEN | MC2 | 2 | 66.68 | 323 | 2 |
| G9107 | MID | MC3 | 2 | 69.85 | 323 | 3 |
| G9108 | | MC4 | 1 | 98.35 | 325 | 9 |
| G9109 | BENDIX | MC5 | 2 | 70.50 | 323 | 4 |
| G9110 | BENDIX | MC6 | 2 | 70.50 | 324 | 5 |
| G9111 | CLAYTON | DEWANDRE | 1 | 66.68 | 323 | 1 |
| G9112 | mitsubishi | 6D16 | 1 | 80.00 | 324 | 6 |
| G9113 | mitsubishi | 6D16T | 1 | 80.00 | 324 | 7 |
| M1101 | YAMAHA | MARINE ENGINE | 1 | 78.00 | 350 | 2 |
| M1102P-6 | YAMAHA | 115/225 HP | 6 | 90.00 | 351 | 6 |
| M1102P | YAMAHA | 115/225 HP | 4 | 90.00 | 350 | 3 |
| M1103P-6 | YAMAHA | 115/225 HP-II | 6 | 90.00 | 351 | 7 |
| M1103P | YAMAHA | 115/225 HP-II | 4 | 90.00 | 350 | 4 |
| M1104P-6 | YAMAHA | SPECIAL J | 6 | 90.00 | 352 | 9 |
| M1104P | YAMAHA | SPECIAL J | 4 | 90.00 | 351 | 5 |
| M1105P | YAMAHA | 225/250 HP | 6 | 90.00 | 351 | 8 |
| M1106 | YAMAHA | WAVE RUNNER VX 110 | | 76.00 | 350 | 1 |
| M2101 | MERCURY | LOW DOME 2.8750" | 3 | 73.03 | 346 | 5 |
| M2101-6 | MERCURY | LOW DOME 2.8750" | 6 | 73.03 | 347 | 11 |
| M2102 | MERCURY | LOW DOME 2.8750"-II | 3 | 73.03 | 346 | 6 |



NUMERICAL INDEX

| TEIKIN NO | ENGINE MODEL | | Cyl. | BORE Ø (mm) | PAGE | BOX NO. |
|-----------|--------------|-----------------------|------|-------------|------|---------|
| M2102-6 | MERCURY | LOW DOME 2.8750"-II | 6 | 73.03 | 347 | 12 |
| M2103 | MERCURY | HIGH DOME 2.8750" | 2 | 73.03 | 345 | 1 |
| M2103-3 | MERCURY | HIGH DOME 2.8750" | 3 | 73.03 | 345 | 3 |
| M2103-4 | MERCURY | HIGH DOME 2.8750" | 4 | 73.03 | 346 | 7 |
| M2103-6 | MERCURY | HIGH DOME 2.8750" | 6 | 73.03 | 347 | 9 |
| M2104 | MERCURY | HIGH DOME 2.8750" -II | 2 | 73.03 | 345 | 2 |
| M2104-3 | MERCURY | HIGH DOME 2.8750" -II | 3 | 73.03 | 345 | 4 |
| M2104-4 | MERCURY | HIGH DOME 2.8750" -II | 4 | 73.03 | 346 | 8 |
| M2104-6 | MERCURY | HIGH DOME 2.8750" -II | 6 | 73.03 | 347 | 10 |
| M2105P | MERCURY | LOOPER 3.1250" | 6 | 79.38 | 348 | 13 |
| M2106P | MERCURY | LOOPER 3.3750" | 6 | 85.73 | 348 | 14 |
| M2107P | MERCURY | OPTIMAX 2.5L | 6 | 88.90 | 349 | 18 |
| M2108P | MERCURY | 2.5L | 6 | 88.90 | 349 | 17 |
| M2109 | MERCURY | 3.5" | 3 | 88.90 | 348 | 15 |
| M2109-4 | MERCURY | 3.5" | 4 | 88.90 | 348 | 16 |
| M3101 | JOHNSON | CROSS FLOW 2.1880" | 2 | 55.58 | 341 | 1 |
| M3102 | JOHNSON | LOOPER 3.0000" | 3 | 76.20 | 341 | 3 |
| M3103 | JOHNSON | CROSS FLOW 3.0000" | 2 | 76.20 | 341 | 2 |
| M3104 | JOHNSON | LOOPER | 3 | 80.96 | 342 | 5 |
| M3105 | JOHNSON | LOOPER 3.1875" | 2 | 80.96 | 341 | 4 |
| M3106P | JOHNSON | LOOPER 3.5000" | 4 | 88.90 | 342 | 7 |
| M3106P-6 | JOHNSON | LOOPER 3.5000" | 6 | 88.90 | 343 | 9 |
| M3106P-8 | JOHNSON | LOOPER 3.5000" | 8 | 88.90 | 343 | 10 |
| M3107 | JOHNSON | CROSS FLOW 3.5000" | 4 | 88.90 | 342 | 6 |
| M3107-6 | JOHNSON | CROSS FLOW 3.5000" | 6 | 88.90 | 342 | 8 |
| M3108P | JOHNSON | 3.600" | 4 | 91.44 | 343 | 11 |
| M3108P-6 | JOHNSON | 3.600" | 6 | 91.44 | 343 | 12 |
| M3109 | JOHNSON | CROSS FLOW 3.6250" | 6 | 92.07 | 344 | 13 |
| M3110P | JOHNSON | 3.685" | 4 | 93.60 | 344 | 14 |
| M3110P-6 | JOHNSON | 3.685" | 6 | 93.60 | 344 | 15 |
| M3110P-8 | JOHNSON | 3.685" | 8 | 93.60 | 344 | 16 |



PISTON PIN LIST

PISTON PIN LIST

| SIZE (DIA X LENGTH) | TEIKIN PIN NUMBER | TEIKIN PISTON NUMBER | ENGINE MODEL | | SIZE (DIA X LENGTH) | TEIKIN PIN NUMBER | TEIKIN PISTON NUMBER | ENGINE MODEL | |
|------------------------|----------------------|----------------------------|-------------------|-----------------------|------------------------|----------------------|----------------------------|--------------|---------------|
| 11.11 x 56.98 | PG9111 | G9111 | CLA | DEWANDRE | 17.00 x 62.00 | P38109 | 38650 | HON | EM1 |
| 13.50 x 59.48 | PG9106 | G9106 | BEN | MC2 | 17.00 x 65.00 | P45125 | 45125 | SUZ | G10 NEW |
| 13.50 x 62.99 | PG9109 | G9109 | BEN | MC5 | | | 45126 | SUZ | G10 |
| | | G9110 | BEN | MC6 | | | 45128 | SUZ | G13B |
| 14.00 x 52.00 | PG5101 | G5101 | ROB | EY-15 | | | 45650 | SUZ | G13-II |
| | | G5102 | ROB | EY-20 | 45125-4 | SUZ | G13 NEW | | |
| 14.26 x 46.00 | PM3101 | M3101 | JOH | CROSS FLOW 2.1880" | 17.45 x 62.00 | P44122 | 44122 | NIS | E10S |
| 14.28 x 60.73 | PG9107 | G9107 | MID | MC3 | 17.45 x 65.50 | P44256 | 44102 | NIS | A12 |
| 15.00 x 42.00 | PG6101 | G6101 | | STIHL | | | 44256 | NIS | A10 |
| 15.00 x 53.50 | PG4101 | G4101 | HON | G-200 | 17.47 x 69.85 | PG9102 | G9102 G9108 | CUM | MC1 MC4 |
| 16.00 x 46.00 | P43680 | 43680 | MIT | 4A31 | 17.97 x 49.00 | P34125 | 34125 | FIA | FIRE 1.3L 8V |
| 16.00 x 49.00 | P45114 | 45114 | SUZ | F8A, LJ80 | | | 34126 | FIA | FIRE 1.3L 16V |
| | | 45138 | SUZ | F6A | 34127 | FIA | FIRE FLEX 1.3L 8V | | |
| | | 45146 | SUZ | WAGON R | 34128 | FIA | FIRE FLEX 1.4L 8V | | |
| | | 45652 | SUZ | F8A | 17.97 x 53.00 | P34122 | 34122 | FIA | FIRE 16V |
| 45146-3 | SUZ | ALTO LXI | 34123 | FIA | | | FIRE 8V | | |
| 16.00 x 52.50 | P45113 | 45117 | SUZ | F10A, SJ410 | 17.98 x 52.40 | P34119 | 34119 | FIA | 160 A3 |
| | | 49104 | DAE | F8C | | | 34121 | FIA | UNO 1100 |
| 16.00 x 53.50 | P45122 | 45122 | SUZ | SS80 | 17.98 x 55.00 | P67101 | 67101 | PEU | 2031 70 |
| 16.00 x 71.00 | PG9112 | G9112 | MIT | 6D16 | 18.00 x 46.50 | P45148 | 45148 | SUZ | K14B |
| | | G9113 | MIT | 6D16T | | | | | |
| 17.00 x 45.00 | P48210 | 48210 | VW | EA111 RSH | 18.00 x 47.50 | P30110 | 30110 | CHE | SAIL 1.4 L |
| | | 48211 | VW | EA111 | | | 30114 | CHE | SPIN 1.5 |
| | | 48212 | VW | EA111 ALCOOL | | | 46341 | TOY | 1SZFE |
| | | 48213 | VW | EA111-II | | | 46385 | TOY | 1SZFE-II |
| | | 48214 | VW | EA111 RSH-II | | | 46677 | TOY | 1KR-FE |
| | | 51141 | HYU | SANTRO XING 1.1 | | | 51115 | HYU | 1.6L |
| 17.00 x 46.50 | P51117 | 51117 | HYU | ATOZ | | | 51116 | HYU | G4FK |
| | | 51118 | HYU | ATOZ-II | | | 51119 | HYU | G4EB |
| | | 52106 | KIA | PICANTO | | | 51128 | HYU | ATTITUDE |
| 17.00 x 50.00 | P45141 | 45141 | SUZ | K12A | | | 51134 | HYU | ACCENT 1.5L |
| | | | | | 51140 | HYU | KAPPA2 | | |
| 17.00 x 51.50 | PM1106 | M1106 | YAM | WAVE RUNNER VX 110 | 56106 | OPE | 1.3 NE | | |
| 17.00 x 52.00 | P48209 | 48209 | VW | LUPO | 18.00 x 48.00 | P46683 | 46683 | TOY | 2SZ-FE |
| | | 48607 | VW | AEA / AEE / AHS / ALM | | | | | |
| 17.00 x 53.00 | P49106 | 30109 | CHE | SPARK GT 1.2 | 18.00 x 50.00 | P45136 | 32150 | DAI | EF |
| | | 32106 | DAI | S-38P (NEW) | | | 41601 | PRO | GEN 2 |
| | | 49106 | DAE | MATIZ II | | | 41602 | PRO | SAGA |
| 17.00 x 54.00 | P48608 | 48608 | VW | AFH / AFK / AHW | | | 43296 | MIT | 3A92 |
| | | | | | | | 45136 | SUZ | ALTO |
| 17.00 x 58.00 | P44600 | 44600 | NIS | MA10 | | | 45145 | SUZ | K10B |
| | | 44650 | NIS | MA10-II | | | 45151 | SUZ | K6A |
| 17.00 x 62.00 | P38109 | 38109 | HON | EN | | | 58104 | GM | CORSA MPFI |
| | | 38112 | HON | ED1 | | | 58105 | GM | CORSA EFI |
| | | 38147 | HON | EJ | | | 58106 | GM | HCV |
| | | 38166 | HON | EF1 | 18.00 x 52.00 | P32605 | 32605 | DAI | EJ-DE / EJ-VE |
| 18.00 x 53.00 | P46332 | 32144 | DAI | K3-DE | | | | | |
| 32146 | | DAI | KANCIL 850 CC NEW | | | | | | |
| 32147 | | DAI | KELISA 1000 CC | | | | | | |
| 32151 | | DAI | EJ-VE-II | | | | | | |

PISTON PIN LIST

| SIZE (DIA X LENGTH) | TEIKIN PIN NUMBER | TEIKIN PISTON NUMBER | ENGINE MODEL | SIZE (DIA X LENGTH) | TEIKIN PIN NUMBER | TEIKIN PISTON NUMBER | ENGINE MODEL | | |
|------------------------|----------------------|----------------------------|--------------------|------------------------|----------------------|----------------------------|---------------|---------------|-----------------------|
| 18.00 x 53.00 | P46332 | 38182 | HON L15A | 18.00 x 61.00 | P43187 | 43176 | MIT 2G23 | | |
| | | 38183 | HON JAZZ RS | | | 43187 | MIT G15B | | |
| | | 44326 | NIS CG13DE | | | 43272 | MIT G15B-II | | |
| | | 44327 | NIS CG10DE | | | 46103 | TOY 3K | | |
| | | 46332 | TOY 1NZFE | | | 46105 | TOY 4K | | |
| | | 46354 | TOY 2NZ-FE | | | 46107 | TOY 5K | | |
| | | 46355 | TOY 2NZ-FE-II | | | 46163 | TOY 3AU | | |
| | | 46356 | TOY 3SZ-VE | | | 46253 | TOY 4AGEC | | |
| | | 46361 | TOY K3-VE | | | 46269 | TOY 4AC | | |
| | | 46364 | TOY 1NZFE-II | | | 46271 | TOY 4AFE-III | | |
| | | 46370 | TOY 1NZ-FXE | | | 46290 | TOY 5AF | | |
| | | 46371 | TOY 1NZFE-III | | | 46335 | TOY 5K-II | | |
| | | 46387 | TOY 3NR-FE | | | 46336 | TOY 4A | | |
| | | 46661 | TOY 1E | | | 46349 | TOY 4A-GEU-II | | |
| | | 51136 | HYU AVANTE 1.6L | | | 46604 | TOY 2A | | |
| | | 51145 | HYU G4FC-II | | | 46610 | TOY 1GE | | |
| 52105 | KIA CARNIVAL | 46618 | TOY 4AGE | | | | | | |
| 56600 | OPE 14 NV | 46658 | TOY 1A | | | | | | |
| | | | | 46670 | TOY 1G-EU | | | | |
| | | | | 46687 | TOY 2A-II | | | | |
| | | | | 55650 | SUB EF10 | | | | |
| 18.00 x 54.00 | P38657 | 38657 | HON L13A4 | 18.00 x 61.00 | P55652 | 55652 | SUB EF12 | | |
| 18.00 x 54.00 | P58107 | 32606 | DAI K3-VE-II | 18.00 x 62.00 | P38652 | 38652 | HON EP | | |
| | | 58107 | GM HCV FLEX | | | | | | |
| 18.00 x 55.00 | P56600 | 56603 | OPE X 1.6 XE / XEL | 18.00 x 62.70 | P39650 | 39650 | ISU 4XC1-II | | |
| 18.00 x 56.00 | P30104 | 30104 | CHE AVEO | 18.00 x 63.00 | P39210 | 39210 | ISU 4XE1V | | |
| | | 30105 | CHE AVEO-II | | | 39603 | ISU 4XC1 | | |
| | | 30107 | CHE AVEO-III | 18.00 x 65.00 | P39652 | 39652 | ISU 4XC1-III | | |
| | | 43216 | MIT 4G17 | | | 18.00 x 66.00 | P39209 | 39209 | ISU 4XE1W |
| | | 43217 | MIT 4G15 | | | | | 18.00 x 70.00 | P38114 |
| | | 43248 | MIT 4G15-II | | | 38179 | HON EK-1-III | | |
| | | 43281 | MIT 4G18 | | | 18.01 x 47.50 | P51600 | 51104 | HYU G4EK - ALPHA - F1 |
| | | 43282 | MIT 4G13-IV | | | | | 51121 | HYU XD |
| | | 43600 | MIT 4G13 | | | 18.01 x 50.00 | P43696 | 51129 | HYU X3-II |
| | | 49101 | DAE LE MANS 1.5 | | | | | 51600 | HYU G4EH |
| | | 49102 | DAE NUBIRA | | | 18.03 x 64.00 | P35600 | 35600 | FOR JLB |
| | | 49103 | DAE CIELO 1.5 | | | | | 18.98 x 58.00 | P42202 |
| | | 49105 | DAE NUBIRA-II | | | 42211 | MAZ Z6 | | |
| | | 56102 | OPE 1.6 SE | | | 42219 | MAZ MZR 1.5L | | |
| | | 56103 | OPE 1.6 SV | | | 18.98 x 59.00 | P42665 | 42665 | MAZ KF |
| | | 56109 | OPE 1.6 LZ | | | | | 18.99 x 52.00 | P44333 |
| 56110 | OPE Z 1.4 XE | 18.99 x 62.00 | P44653 | | | 44653 | NIS RB20E | | |
| 56113 | OPE X18XE | | | | | 19.00 x 42.00 | P48215 | 48215 | VW 2.0 L LATE |
| 18.00 x 58.00 | P46603 | 44687 | NIS CG13DE-II | 19.00 x 44.00 | P48208 | | | 48208 | VW BGP/BGQ |
| | | 46603 | TOY 2K | | | 19.00 x 47.00 | P44609 | 44609 | NIS GA13 |
| | | 18.00 x 59.00 | P46141 | 43257 | MIT 4G13-II | | | 19.00 x 49.00 | P44677 |
| 43652 | MIT 4G13-III | | | 44691 | NIS QG15 | | | | |
| 46141 | TOY 2E | | | | | | | | |
| 46258 | TOY 5E-FE | | | | | | | | |
| 46274 | TOY 3E | | | | | | | | |
| 46345 | TOY 2E-II | | | | | | | | |
| 46346 | TOY 4E-FE-II | | | | | | | | |
| 53101 | ASI TOWNER | | | | | | | | |
| 18.00 x 60.00 | P32601 | 32601 | DAI CD | | | | | | |
| | | 43607 | MIT 4G12 | | | | | | |
| | | 43616 | MIT 4G11 | | | | | | |
| 18.00 x 61.00 | P43187 | 32110 | DAI S-10P | | | | | | |
| | | 32117 | DAI G11 | | | | | | |
| | | 32124 | DAI S75 | | | | | | |
| | | 39659 | ISU 4XC1-IV | | | | | | |



PISTON PIN LIST

| SIZE (DIA X LENGTH) | TEIKIN PIN NUMBER | TEIKIN PISTON NUMBER | ENGINE MODEL | | SIZE (DIA X LENGTH) | TEIKIN PIN NUMBER | TEIKIN PISTON NUMBER | ENGINE MODEL | | | | | |
|---------------------|-------------------|----------------------|---------------|------------|---------------------|-------------------|----------------------|--------------|---------------------|---------|---------------------|--------|----------------|
| 19.00 x 50.00 | P48205 | 30112 | CHE | CRUZE 1.8L | 19.00 x 62.00 | P44259 | 44259 | NIS | E16i | | | | |
| | | 44337 | NIS | GA15DS-II | | | 44268 | NIS | E16 | | | | |
| | | 44610 | NIS | GA15DS | | | 44324 | NIS | A15-II | | | | |
| | | 44614 | NIS | GA14DS | | | 44329 | NIS | E16-T | | | | |
| | | 44669 | NIS | GA14 | | | 44355 | NIS | E15-III | | | | |
| | | 48205 | VW | AEB-II | | | 44611 | NIS | E13 | | | | |
| 19.00 x 51.50 | P44682 | 44682 | NIS | QG18DE | 19.00 x 63.00 | P44322 | 44322 | NIS | A14-II | | | | |
| | | | | | | | | | | | | | |
| 19.00 x 52.00 | P44258 | 44258 | NIS | GA16i | | | 19.00 x 64.00 | P43132 | 43132 | MIT | 4G32 | | |
| | | 44260 | NIS | GA16DE | | | | | 43137 | MIT | 4G33 | | |
| | | 44270 | NIS | GA16DE-II | | | | | 43144 | MIT | 4G41R NEW | | |
| | | 44306 | NIS | GA16DS-II | | | | | 43195 | MIT | G37B | | |
| | | 44688 | NIS | QG16 | 43219 | MIT | | | 4G37 | | | | |
| | | 44690 | NIS | QG16DE | 43221 | MIT | | | 4G32-M | | | | |
| 19.00 x 53.50 | P44339 | 44339 | NIS | HR15DE | 19.05 x 67.20 | PM3102 | M3102 | JOH | LOOPER 3.0000" | | | | |
| | | 44345 | NIS | HR16DE | | | M3103 | JOH | CROSS FLOW 3.0000" | | | | |
| | | 44351 | NIS | HR12DE | | | 19.05 x 71.20 | PM3104 | M3104 | JOH | LOOPER | | |
| | | | M3105 | JOH | | | | | LOOPER 3.1875" | | | | |
| | | | M3108P | JOH | | | | | 3.600" V4 | | | | |
| | | | M3108P-6 | JOH | | | | | 3.600" V6 | | | | |
| | | | | | | | | | | | | | |
| | | | | | | | | | | | | | |
| 19.99 x 53.00 | P44340 | 44340 | NIS | MR18DE | 19.05 x 79.20 | PM3107 | M3107 | JOH | CROSS FLOW 3.5000" | | | | |
| | | 44350 | NIS | MR20DE | | | M3107-6 | JOH | CROSS FLOW 3.5000" | | | | |
| | | 48203 | VW | AEG | | | M3109 | JOH | CROSS FLOW 3.6250" | | | | |
| 19.00 x 55.00 | P44695 | 38666 | HON | D13 | | | 19.55 x 61.00 | PM2101 | M2101 | MER | LOW DOME 2.8750" | | |
| | | 44695 | NIS | GA16DE-III | | | | | M2101-6 | MER | LOW DOME 2.8750" | | |
| 19.00 x 56.00 | P38145 | 38145 | HON | D15B2 | | | | | M2102 | MER | LOW DOME 2.8750"-II | | |
| | | 38146 | HON | D16A6 | M2102-6 | MER | | | LOW DOME 2.8750"-II | | | | |
| | | 38149 | HON | D16Z6 | M2103 | MER | | | HIGH DOME 2.8750" | | | | |
| | | 38153 | HON | D16Y8 | M2103-3 | MER | | | HIGH DOME 2.8750" | | | | |
| | | 38159 | HON | D15Z1 | M2103-4 | MER | HIGH DOME 2.8750" | | | | | | |
| | | 38169 | HON | D17A2 | M2103-6 | MER | HIGH DOME 2.8750" | | | | | | |
| | | 38170 | HON | D17A1 | M2104 | MER | HIGH DOME 2.8750"-II | | | | | | |
| | | 38173 | HON | D16A6-II | M2104-3 | MER | HIGH DOME 2.8750"-II | | | | | | |
| | | 38181 | HON | D16Y7 | M2104-4 | MER | HIGH DOME 2.8750"-II | | | | | | |
| | | 38187 | HON | D15B-II | M2104-6 | MER | HIGH DOME 2.8750"-II | | | | | | |
| | | 38600 | HON | EV | 19.55 x 66.80 | PM2105P | M2105P | MER | LOOPER 3.1250" | | | | |
| | | 38603 | HON | EW | | | 19.55 x 68.60 | PM2109 | M2109 | MER | 3.5" | | |
| | | 38605 | HON | EW-II | | | | | M2109-4 | MER | 3.5" | | |
| | | 38606 | HON | D16A | | | | | 19.55 x 73.80 | PM2106P | M2106P | MER | LOOPER 3.3750" |
| | | 38656 | HON | D15 | | | | | | | M2108P | MER | 2.5L |
| | | 38663 | HON | D15A3 EW4 | | | | | | | 19.90 x 64.00 | PM1101 | M1101 |
| 38665 | HON | D16A-II | 19.96 x 46.00 | P38186 | 38186 | HON | | | | | | | R20A |
| 38667 | HON | D15-II | | | 38659 | HON | R18A1/A2 | | | | | | |
| 19.00 x 58.00 | P32125 | 32125 | | | DAI | S89 | | | | | | | |
| | | 32142 | | | DAI | HD | | | | | | | |
| | | 32145 | | | DAI | S89-II | | | | | | | |
| | | 42166 | | | MAZ | FS | | | | | | | |
| | | 43288 | MIT | 4G94 | | | | | | | | | |
| | | 43657 | MIT | 4G92S-H | | | | | | | | | |
| | | 43658 | MIT | 4G93 | | | | | | | | | |
| | | 43677 | MIT | 6A12 | | | | | | | | | |
| | | 43679 | MIT | 4G93-II | | | | | | | | | |
| 19.00 x 61.00 | P45127 | 43671 | MIT | 4G92S | | | | | | | | | |
| | | 45127 | SUZ | SL413-II | | | | | | | | | |
| | | 45132 | SUZ | VITARA | | | | | | | | | |
| | | 45135 | SUZ | STEAM 1.3L | | | | | | | | | |
| | | 45653 | SUZ | G13BB | | | | | | | | | |
| | | 45654 | SUZ | G13B-II | | | | | | | | | |
| 45655 | SUZ | G13-Y58 | | | | | | | | | | | |
| 19.00 x 62.00 | P44259 | 44125 | NIS | E15 | | | | | | | | | |

PISTON PIN LIST

| SIZE (DIA X LENGTH) | TEIKIN PIN NUMBER | TEIKIN PISTON NUMBER | ENGINE MODEL | SIZE (DIA X LENGTH) | TEIKIN PIN NUMBER | TEIKIN PISTON NUMBER | ENGINE MODEL | | |
|------------------------|--------------------------|----------------------------|---------------------------|------------------------|----------------------|----------------------------|-----------------------|-------|-------------|
| 19.98 x 52.00 | P52110 | 42217 | MAZ B3-III | 20.00 x 56.58 | P42165 | 48206 | VW 2.5 / 2.6 MICROBUS | | |
| | | 52102 | KIA DC | | | 48600 | VW PL 4 KAT | | |
| | | 52110 | KIA B1 | | | | | | |
| | | 52111 | KIA RIO 1.6L | | | | | | |
| 19.98 x 56.00 | P42656 | 42656 | MAZ TB | 20.00 x 57.00 | P44675 | 44675 | NIS K21 | | |
| | | | | | | 44676 | NIS K25 | | |
| | | | | | | 48604 | VW 1F / ABN / DT / EW | | |
| | | | | | | 61601 | AUD AAR / NF / NG | | |
| 19.98 x 61.00 | P42173 | 42173 | MAZ Z5 | 20.00 x 57.00 | P48609 | 48606 | VW ADP / AEK / AFT | | |
| | | 42214 | MAZ ZM | | | 48609 | VW AAM/ADF/DS/EX/RP | | |
| | | 42653 | MAZ B5 | | | | | | |
| | | 52113 | KIA SEPHIA-II | | | | | | |
| 19.98 x 65.00 | P42146 | 42131 | MAZ E3 | 20.00 x 57.50 | P45657 | 45657 | SUZ M15A-II | | |
| | | 42140 | MAZ NA NEW | | | 20.00 x 58.00 | P52112 | 45656 | SUZ M13A |
| | | 42142 | MAZ NA NEW - II | | | | | 52112 | KIA SPECTRA |
| | | 42146 | MAZ MA | | | | | 58102 | GM L61 |
| | | 42171 | MAZ B6 | 20.00 x 59.00 | P51101 | | | 35180 | FOR 2.0 L |
| | | 42172 | MAZ B6 - II | | | 45134 | SUZ H20A | | |
| | | 42196 | MAZ E5-II | | | 45143 | SUZ M15A | | |
| | | 42203 | MAZ MA-IV | | | 48204 | VW AEB | | |
| 52103 | KIA B6D | 51101 | HYU J2 (BETA) | | | | | | |
| | | 51105 | HYU G4DR - BETA - J2 | | | | | | |
| | | 51120 | HYU G4DR - BETA - J2 - II | | | | | | |
| | | 51122 | HYU MATRIX 1.8L | | | | | | |
| | | 51127 | HYU 2.0L | | | | | | |
| | | 51131 | HYU G4GF | | | | | | |
| | | 48611A | VW BPY/CBFA/CCTA ALFIN | | | | | | |
| 19.99 x 61.00 | P42661 | 42661 | MAZ BP | 20.00 x 61.00 | P46310 | 42672 | MAZ ZL-VE | | |
| 19.99 x 57.00 | P44328 | 42668 | MAZ B6ZE | | | 44617 | NIS L24E | | |
| | | 44328 | NIS QR25DE | | | 44661 | NIS CA18ET | | |
| | | 44343 | NIS QR25DE-III | | | 44663 | NIS CA20-III | | |
| | | 44349 | NIS QR25DE-IV | | | 46310 | TOY 4AGELC | | |
| | | 44353 | NIS QR25DE-V | | | | | | |
| 19.99 x 59.00 | P44342 | 44342 | NIS QR20DE | 20.00 x 62.00 | P38129 | 38129 | HON BS | | |
| | | 52108 | KIA CREDOS | | | 38602 | HON ES | | |
| 19.99 x 61.50 | P42662 | 42662 | MAZ B6-T | | | 38604 | HON ES-II | | |
| | | 42664 | MAZ KL | | | 38654 | HON A20A BS-II | | |
| 19.99 x 65.00 | P42600 | 42600 | MAZ UC | | | 38655 | HON ES1 | | |
| | | 42652 | MAZ E3-II | | | 38664 | HON B20A3 | | |
| 20.00 x 50.00 | P46688 | 46688 | TOY 3ZR-FE-II | 44186 | NIS CA16 | | | | |
| 20.00 x 52.00 | PG2101 | 42127 | MAZ B3 | 44190 | NIS CA18 | | | | |
| | | 42660 | MAZ B3-II | 44193 | NIS CA20 | | | | |
| | | G2101 | MIT MN55 | 44279 | NIS CA20-II | | | | |
| | | G2105 | MIT NM45 | 44608 | NIS H20-II | | | | |
| 20.00 x 53.00 | P52654 | 52654 | KIA A3E | 46286 | TOY 4 A-GEU | | | | |
| 20.00 x 54.00 | P48605 | 48605 | VW 2G / AAV / HK | 56111 | OPE Z 22 SE | | | | |
| 20.00 x 55.00 | P42108 | 42108 | MAZ PB | 20.00 x 65.00 | P56101 | 42607 | MAZ TC LATE | | |
| | | 42651 | MAZ TC | | | 46612 | TOY 4P(High) | | |
| | | 42670 | MAZ TC-II | | | 46615 | TOY 3P | | |
| 20.00 x 56.58 | P42165 | 42165 | MAZ BP05 | | | 46651 | TOY 4P(Low) | | |
| | | 42200 | MAZ BP-II | | | 56101 | OPE 1300S | | |
| | | 42208 | MAZ BP-III | | | 20.00 x 66.00 | P46187 | 42132 | MAZ E5 NEW |
| | | 46262 | TOY 4AFE | 42170 | MAZ VC NEW | | | | |
| 46266 | TOY 4AFE-II | 46116 | TOY 1S | | | | | | |
| 46277 | TOY 7AFE | 46187 | TOY 12R | | | | | | |
| 46664 | TOY 4A-GEU - VVT | 46255 | TOY 3SFE | | | | | | |
| 48107 | VW ET/ZF/EP 1981 -ON | 46289 | TOY 4SFI | | | | | | |
| 48110 | VW E-II, ABS KAT, DS, DX | 46614 | TOY 2R | | | | | | |
| 48111 | VW 9A | 46627 | TOY 2S | | | | | | |
| 48201 | VW JS KAT | | | 20.01 x 50.00 | P46334 | 46334 | TOY 1ZZFE | | |



PISTON PIN LIST

| SIZE (DIA X LENGTH) | TEIKIN PIN NUMBER | TEIKIN PISTON NUMBER | ENGINE MODEL | SIZE (DIA X LENGTH) | TEIKIN PIN NUMBER | TEIKIN PISTON NUMBER | ENGINE MODEL | | | | | | | | | | | | | | | | | | | | | | | | | | | | | | | | | |
|---------------------|-------------------|----------------------|---------------------|---------------------|-------------------|----------------------|----------------|--------------|-------|----------------|---------------|-----------|------------------|--------|-------|-------------------------|----------|--------|--------|-----------|------------|-------|----------------|-------|---------------|--------|-------|---------|-------------|--------|----------------|-----------|--------|-----------|-----------|-------|--------|--------|-------|-----------|
| 20.01 x 50.00 | P46334 | 46342 | TOY 4ZZFE | 21.00 x 59.00 | P45131 | 45147 | SUZ SX4 | | | | | | | | | | | | | | | | | | | | | | | | | | | | | | | | | |
| | | 46367 | TOY 3ZZ-FE | | | 45150 | SUZ J20A-II | | | | | | | | | | | | | | | | | | | | | | | | | | | | | | | | | |
| | | 46382 | TOY 1ZR-FE | | | 48610 | VW 2E,ADY,AGG | | | | | | | | | | | | | | | | | | | | | | | | | | | | | | | | | |
| | | 46383 | TOY 2ZR-FE | | | 51111 | HYU G6BV DELTA | | | | | | | | | | | | | | | | | | | | | | | | | | | | | | | | | |
| | | 46384 | TOY 3ZR-FE | | | 51113 | HYU G6BA | | | | | | | | | | | | | | | | | | | | | | | | | | | | | | | | | |
| 20.01 x 56.58 | P46340 | 46340 | TOY 2ZZFE | 21.00 x 60.00 | P42676 | 42676 | MAZ L8 | | | | | | | | | | | | | | | | | | | | | | | | | | | | | | | | | |
| | | 46347 | TOY 5AFE NEW | | | | | | | | | | | | | | | | | | | | | | | | | | | | | | | | | | | | | |
| | | 46358 | TOY 7K-II | | | | | | | | | | | | | | | | | | | | | | | | | | | | | | | | | | | | | |
| | | 46377 | TOY 1G-FE | | | | | | | | | | | | | | | | | | | | | | | | | | | | | | | | | | | | | |
| 20.01 x 56.58 | P46259 | 46259 | TOY 7K | | | | 21.00 x 61.50 | P56104 | 30106 | CHE OPTRA 1.8L | | | | | | | | | | | | | | | | | | | | | | | | | | | | | | |
| 20.63 x 70.60 | P47101 | 47101 | JEE 88 ANP | | | | | | | 30111 | P56104 | 30111 | CHE CAPTIVA 2.4L | | | | | | | | | | | | | | | | | | | | | | | | | | | |
| | | 47102 | JEE 488 ANP | | | | | | | | | | 35181 | P56104 | 35181 | FOR AODA/B,C,JBA/B,N4JB | | | | | | | | | | | | | | | | | | | | | | | | |
| | 20.63 x 63.00 | P35177 | 35177 | | | | | | | | | | | | | FOR ZETEC | 39211 | P56104 | 39211 | ISU X22SE | | | | | | | | | | | | | | | | | | | | |
| | | | 35179 | | | | | | | | | | | | | FOR VIN 3 ZETEC | | | | 39229 | P56104 | 39229 | ISU X20SE | | | | | | | | | | | | | | | | | |
| 35191 | | | FOR CVH 2.0 | | | | | | | | | | | | | 39230 | | | | | | | P56104 | 39230 | ISU X22SE-II | | | | | | | | | | | | | | | |
| 20.63 x 67.00 | P35170 | 35170 | FOR CVH-LUC | | | | | | | | | | | | | | | | | | | | | | 39233 | P56104 | 39233 | ISU LUV | | | | | | | | | | | | |
| | | 35171 | FOR CVH-FUA | | | | | | | | | | | | | | | | | | | | | | | | | 39235 | P56104 | 39235 | ISU DIMAX 2.4L | | | | | | | | | |
| | | 35173 | FOR CVH | | | | | | | | | | | | | | | | | | | | | | | | | | | | 42205 | P56104 | 42205 | MAZ L3 | | | | | | |
| | | 35178 | FOR MOT. 1.9 Lt | 42209 | P56104 | 42209 | | | | | | | | | | | | | | | | | | | | | | | | | | | | MAZ L3-II | | | | | | |
| 20.64 x 71.30 | P35165 | 35165 | FOR 40065 | | | | | | | | | | | | | | | | | | | | | | | | | | | | | | | 42210 | P56104 | 42210 | MAZ LF | | | |
| 20.65 x 74.00 | P44235 | 44235 | NIS P680 | | | | | | | | | | | | | | | | | | | | | | | | | | | | | | | | | | 42216 | P56104 | 42216 | MAZ LF-II |
| 20.98 x 60.00 | P44274 | 44274 | NIS VG33E | | | | | | | | | | | | | | | | | | | | | | | | | | | | | | | | | | | | | 44272 |
| | | 44321 | NIS KA24DE | | | | 56104 | P56104 | 56104 | | | | | | | | | | | | | | | | | | | | | | | | | | | | | | | |
| 20.98 x 64.00 | P44277 | 44275 | NIS VG30E | | | | | | | 56107 | P56104 | 56107 | | | | | | | | | | | | | | | | | | | | | | | | | | | | |
| | | 44277 | NIS VG30i | | | | | | | | | | 56108 | P56104 | 56108 | | | | | | | | | | | | | | | | | | | | | | | | | |
| | | 44334 | NIS VG30i-II | | | | | | | | | | | | | | 56112 | P56104 | 56112 | | | | | | | | | | | | | | | | | | | | | |
| 20.99 x 56.00 | P44338 | 44338 | NIS KA24DE-IV | | | | | | | | | | | | | | | | | 56601 | P56104 | 56601 | | | | | | | | | | | | | | | | | | |
| | | 20.99 x 64.00 | P44664 | | | | | | | | | | | | | 44664 | | | | | | | NIS RB30E | 56604 | | | | | | | | | | | | | | | | |
| 21.00 x 45.00 | P42220 | | | | | | | | | | | | | | | 42220 | | | | | | | MAZ SKYACTIV-G | | 21.00 x 63.50 | P32120 | 32120 | | | | | | | | | | | | | |
| 21.00 x 49.50 | P42223 | 42223 | MAZ SKYACTIV-G 2.5L | | | | | | | | | | | | | 44352 | | | | | | | P32120 | | | | | 44352 | NIS NA20-II | | | | | | | | | | | |
| 21.00 x 54.00 | P33101 | 33101 | CRY TIGGO | | | | | | | | | | | | | | | | | | | | | | | | | | 44604 | P32120 | 44604 | NIS NA20 | | | | | | | | |
| 21.00 x 56.00 | P38151 | 38151 | HON B18C1 | 44615 | P32120 | 44615 | | | | | | | | | | | | | | | | | | | | | | | | | | NIS NA16S | | | | | | | | |
| | | 38152 | HON B18B1 | | | | | | | | | | | | | | | | | | | | | | | | | | | | | 44606 | P32120 | 44606 | TOY 3VZE | | | | | |
| | | 38154 | HON B20B4 | | | | | | | | | | | | | | | | | | | | | | 58103 | P32120 | 58103 | | | | | | | | GM ASTRA | | | | | |
| | | 38155 | HON B16A2 | | | | | | | | | | | | | 21.00 x 66.00 | | | | | | | P44121 | | | | | 43231 | | | | | | | MIT 4G63D | | | | | |
| | | 38171 | HON B20Z2 | | | | 43234 | P44121 | 43234 | | | | | | | | | | | | | | | | | | | | MIT 4G63D-T | | | | | | | | | | | |
| | | 48113 | VW ABA | 43250 | P44121 | 43250 | | | | MIT 4G61 | | | | | | | | | | | | | | | | | | | | | | | | | | | | | | |
| 48207 | VW ABA-II | 43676 | P44121 | | | | | | | 43676 | MIT G63DH | | | | | | | | | | | | | | | | | | | | | | | | | | | | | |
| 21.00 x 56.50 | P38668 | | | | | | | | | | 38668 | HON B18A1 | 44121 | P44121 | 44121 | | NIS J15 | | | | | | | | | | | | | | | | | | | | | | | |
| | | | | | | | | | | | 21.00 x 58.00 | P43692 | | | | 43692 | MIT 4B11 | 44232 | P44121 | 44232 | NIS Z24 | | | | | | | | | | | | | | | | | | | |
| 43694 | MIT 4B12 | | | | | | 44265 | P44121 | 44265 | | | | | | | NIS J18 | | | | | | | | | | | | | | | | | | | | | | | | |
| 21.00 x 59.00 | P45131 | | | 45131 | SUZ H25A | 44269 | | | | | | | | | | P44121 | 44269 | | | | NIS Z16 | | | | | | | | | | | | | | | | | | | |
| | | 45133 | SUZ J20A | 44271 | P44121 | | | | | 44271 | | | | | | | | | | | NIS KA24E | | | | | | | | | | | | | | | | | | | |
| | | 45137 | SUZ H27 | | | | | | | | | | 44278 | P44121 | 44278 | | | | | | NIS Z22 | | | | | | | | | | | | | | | | | | | |
| | | 45139 | SUZ J24B | | | | | | | | | | | | | | | 44316 | P44121 | 44316 | NIS Z24-II | | | | | | | | | | | | | | | | | | | |
| | | 45140 | SUZ AERIO | | | | 51114 | P44121 | 51114 | | HYU G4DM | | | | | | | | | | | | | | | | | | | | | | | | | | | | | |
| | | 45142 | SUZ H27-II | | | 51137 | | | | | P44121 | 51137 | | | | HYU 15D | | | | | | | | | | | | | | | | | | | | | | | | |
| 21.00 x 70.00 | P55653 | 55653 | SUB EA82 | 21.00 x 72.00 | P44662 | | | | | 44662 | | | | | | NIS L16-III | | | | | | | | | | | | | | | | | | | | | | | | |
| | | 55653 | SUB EA82 | | | | | | | 44699 | | | NIS H25 | | | | | | | | | | | | | | | | | | | | | | | | | | | |
| 21.00 x 72.50 | P43155 | 43154 | MIT 4G62 | 21.00 x 72.50 | P43155 | | | | | 43154 | | | MIT 4G62 | | | | | | | | | | | | | | | | | | | | | | | | | | | |
| | | 43155 | MIT 4G63 OLD | | | | 43155 | MIT 4G63 OLD | | | | | | | | | | | | | | | | | | | | | | | | | | | | | | | | |
| | | 43207 | MIT G63B NEW | | | 43207 | MIT G63B NEW | | | | | | | | | | | | | | | | | | | | | | | | | | | | | | | | | |
| | | 43230 | MIT 420A | | | 43230 | MIT 420A | | | | | | | | | | | | | | | | | | | | | | | | | | | | | | | | | |
| | | | | | | | | | | | | | | | | | | | | | | | | | | | | | | | | | | | | | | | | |

PISTON PIN LIST

| SIZE (DIA X LENGTH) | TEIKIN PIN NUMBER | TEIKIN PISTON NUMBER | ENGINE MODEL | SIZE (DIA X LENGTH) | TEIKIN PIN NUMBER | TEIKIN PISTON NUMBER | ENGINE MODEL | | |
|---------------------|-------------------|----------------------|--------------|---------------------|-------------------------|----------------------|------------------|-------|------------|
| 21.00 x 72.50 | P43155 | 43258 | MIT 4G64N | 21.98 x 67.00 | P42164 | 42603 | MAZ FE-IV | | |
| | | 43621 | MIT G63B-II | | | 21.98 x 67.00 | P59101 | 59101 | LAD 2101 |
| | | 44160 | NIS L24 | 59103 | LAD 21011 | | | | |
| | | 44166 | NIS L18 NEW | 59105 | LAD 21083 | | | | |
| | | 44167 | NIS L18 OLD | 59108 | LAD 21213 | | | | |
| | | 44224 | NIS Z20 | 59109 | LAD VAZ 2105 | | | | |
| | | 44227 | NIS Z20S | 21.98 x 71.00 | P34113 | | | 34113 | FIA 124S |
| | | 44230 | NIS Z22S | | | 21.99 x 58.00 | P44273 | 34120 | FIA 160 A1 |
| | | 44283 | NIS L16-II | | | | | 34130 | FIA SHAHEN |
| | | 44305 | NIS L20B | 44273 | NIS VQ30DE | | | | |
| | | 44335 | NIS L28S | 44325 | NIS VQ30DE-II | | | | |
| | | 44336 | NIS L24S | 44331 | NIS VQ35DE-II | | | | |
| | | 44616 | NIS L28 | 44332 | NIS VQ35DE | | | | |
| | | 51125 | HYU Y2 | 44341 | NIS VQ40DE | | | | |
| 44160-4 | NIS L16 | 21.00 x 82.00 | P55651 | 55651 | SUB EA71 | | | | |
| 21.00 x 62.50 | P46660 | | | 46660 | TOY 2VZ-FE | | | | |
| | | 21.01 x 60.50 | P42207 | 42207 | MAZ AJ | | | | |
| 21.02 x 55.50 | P42199 | | | 42199 | MAZ GY | | | | |
| | | 21.50 x 76.00 | PM1104P | M1104P | YAM SPECIAL J | | | | |
| M1104P-6 | YAM SPECIAL J | | | | | | | | |
| 21.95 x 60.50 | P39237 | 39237 | ISU 6VE1-III | 22.00 x 52.00 | P55106 | 55106 | SUB EZ30D | | |
| | | 55107 | SUB EZ30D-II | | | | | | |
| 21.97 x 52.00 | P38174 | 38174 | HON K24A1 | 22.00 x 55.00 | P48102 | 46288 | TOY 1MZFE | | |
| | | 38175 | HON K24A4 | | | 48102 | VW FR/JB, FP WV | | |
| | | 38184 | HON K24A4-II | 54102 | BMW M 20 B 25 M1 Z7 KAT | | | | |
| | | 38185 | HON K20A3 | 22.00 x 56.00 | P34101 | 29119 | MER M102.945 | | |
| | | 38188 | HON K24Z3 | | | 29601 | MER M102 E20/V20 | | |
| | | 38189 | HON K24A2 | | | 34101 | FIA 103 | | |
| | | 38190 | HON K20A2 | | | 38148 | HON B21A1 | | |
| | | 38191 | HON K24Z2 | | | 38150 | HON F18A | | |
| | | 38197 | HON ACCORD | | | 38156 | HON H22A1 | | |
| | | 38198 | HON K24A | | | 38158 | HON H23A1 | | |
| | | 38199 | HON K20A5 | | | 38168 | HON C27A4 | | |
| 21.97 x 54.00 | P38172 | 38172 | HON F23A5 | | | 38651 | HON F22A | | |
| | | 38176 | HON J35A1 | | | 46343 | TOY 2AZFE | | |
| | | 38177 | HON J35A3 | | | 46353 | TOY 1AZFE | | |
| | | 38178 | HON J30A4 | 46357 | TOY 3MZFE | | | | |
| | | 38180 | HON F23A1 | 46363 | TOY 2GR-FE | | | | |
| | | 38192 | HON J35A7 | 46365 | TOY 1AZ-FSE | | | | |
| | | 38193 | HON J32A3 | 46366 | TOY 1TR-FE | | | | |
| | | 38194 | HON J35A8 | 46373 | TOY 3SFE-VII | | | | |
| | | 38195 | HON J30A | 46378 | TOY 3S-FSE | | | | |
| | | 38196 | HON J35Z3 | 46379 | TOY 2AZFE-II | | | | |
| | | 21.97 x 57.00 | P38157 | 38157 | HON H22A4 | 22.00 x 57.00 | P38660 | 38660 | HON B20A5 |
| 57101 | ACU C35A1 | | | 38662 | HON C32A | | | | |
| 21.98 x 60.00 | P59106 | 59106 | LAD 2110 | 22.00 x 58.00 | P43290 | 43290 | MIT 6G75 | | |
| | | 59107 | LAD VAZ 2112 | | | 43297 | MIT 6B31 | | |
| 21.98 x 67.00 | P42164 | 42157 | MAZ FE | 22.00 x 59.60 | P44680 | 44680 | NIS VK56DE | | |
| | | 42159 | MAZ F6 | | | 22.00 x 60.00 | P34102 | 31117 | CHR 2.7 L |
| | | 42164 | MAZ F2 | 34102 | FIA 1100D | | | | |
| | | 42168 | MAZ F8 | 34109 | FIA 1300 | | | | |
| | | 42192 | MAZ F2-II | 39170 | ISU 4EC1 OLD | | | | |
| | | 42193 | MAZ FE-II | | | | | | |
| | | 42218 | MAZ FE-VIII | | | | | | |

PISTON PIN LIST

| SIZE (DIA X LENGTH) | TEIKIN PIN NUMBER | TEIKIN PISTON NUMBER | ENGINE MODEL | | SIZE (DIA X LENGTH) | TEIKIN PIN NUMBER | TEIKIN PISTON NUMBER | ENGINE MODEL | | | |
|------------------------|----------------------|----------------------------|--------------|-----------------|------------------------|----------------------|----------------------------|--------------|----------------|--|--|
| 22.00 x 60.00 | P34102 | 44601 | NIS | SR20DE | 22.00 x 66.00 | P39104 | 46207 | TOY | 2T | | |
| | | 44652 | NIS | SR20DE-II | | | 46211 | TOY | 2T-U | | |
| | | 58101 | GM | MOT.146 | | | 46218 | TOY | 3T | | |
| 22.00 x 62.00 | P43222 | 35174 | FOR | 281 | | | 46263 | TOY | 3SGTE | | |
| | | 43222 | MIT | 4G63-P | | | 46267 | TOY | 21R-II | | |
| | | 43225 | MIT | 4G64S | | | 46275 | TOY | 7MGTE | | |
| | | 43226 | MIT | 4G63DK | | | 46279 | TOY | 5SFE | | |
| | | 43228 | MIT | 4G64 | | | 46280 | TOY | 7MGE | | |
| | | 43261 | MIT | 4G63K | | | 46309 | TOY | 5SFE-II | | |
| | | 43270 | MIT | 4G64-II | | | 46330 | TOY | 2JZGE | | |
| | | 43276 | MIT | G64FR | | | 46338 | TOY | 2T/2TB | | |
| | | 43279 | MIT | 4G63N | | | 46352 | TOY | 2JZGE-II | | |
| | | 43287 | MIT | 4G69 | | | 46376 | TOY | 4SFI-II | | |
| | | 46281 | TOY | 3VZ-FE | | | 46605 | TOY | 5M | | |
| | | 46337 | TOY | 2UZFE | | | 46619 | TOY | 2TC | | |
| | | 46350 | TOY | 1UZFE-II | 46620 | TOY | 3SFE-II | | | | |
| | | 46360 | TOY | 2TR-FE | 46621 | TOY | 3SFE-III | | | | |
| | | 46368 | TOY | 1GR-FE | 46663 | TOY | 3SGE | | | | |
| | | 46665 | TOY | 1UZFE | 46667 | TOY | 3SFE-IV | | | | |
| | | 46666 | TOY | 5VZ-FE | 46689 | TOY | 3SGE-II | | | | |
| 51110 | HYU | G6BV | 46331G | TOY | 2JZGTE GALLERY | | | | | | |
| 51130 | HYU | G4JP | | | | | | | | | |
| 54101 | BMW | M 20 B 20 L | | | | | | | | | |
| 67102 | PEU | 2297 50 | | | | | | | | | |
| | | | | | | | | | | | |
| | | | | | 22.00 x 66.00 | P46632 | 46632 | TOY | 5MGEU | | |
| | | | | | 22.00 x 67.00 | P44703 | 42678 | MAZ | F2T | | |
| 22.00 x 64.00 | P43220 | 34131 | FIA | TEMPRA 1600 TWO | 22.00 x 69.50 | P46202 | 35166 | FOR | 40090 | | |
| | | 43220 | MIT | 6G72 NEW | | | 35167 | FOR | 40091 | | |
| | | 43235 | MIT | 6G72-T | | | 39175 | ISU | 4ZC1 | | |
| | | 43247 | MIT | 6G74 | | | 39628 | ISU | G161Z-II | | |
| | | 43249 | MIT | 6G72H | | | 46202 | TOY | 22R-E | | |
| | | 43263 | MIT | 6G73 | | | | | | | |
| | | 43271 | MIT | 6G74-II | | | | | | | |
| | | 43278 | MIT | 6G72-II | | | | | | | |
| | | 43284 | MIT | 6G74-III | | | | | | | |
| | | 43294 | MIT | 6G72-V | | | | | | | |
| | | 43667 | MIT | 6G72-IV | | | | | | | |
| | | 51123 | HYU | XG350 | | | | | | | |
| | | 60102 | VOL | GAZ 4062.10 | | | | | | | |
| 60103 | VOL | 405 | | | | | | | | | |
| | | | | | | | | | | | |
| | | | | | 22.00 x 71.00 | P42612 | 42612 | MAZ | VA | | |
| 22.00 x 64.00 | P43669 | 43669 | MIT | 6G72-III | 22.00 x 72.00 | P46199 | 34103 | FIA | 125 | | |
| | | | | | | | 42206 | MAZ | FE-VII | | |
| | | | | | | | 42602 | MAZ | FE-III | | |
| | | | | | | | 46199 | TOY | 21R | | |
| | | | | | | | 46653 | TOY | 21R-III | | |
| | | | | | | | 48108 | VW | 1600-HIGH, 311 | | |
| | | | | | | | 48109 | VW | 1600-LOW, AM | | |
| | | | | | | | 52101 | KIA | FE | | |
| | | | | | | | | | | | |
| | | | | | | | | | | | |
| 22.00 x 65.00 | P42141 | 42141 | MAZ | NA OLD | 22.00 x 72.60 | P31116 | 31116 | CHR | 2.4 L | | |
| | | 42152 | MAZ | VC OLD | | | 31118 | CHR | EDZ | | |
| | | | | | | | 44196 | NIS | H20 | | |
| 22.00 x 65.00 | P46662 | 46662 | TOY | 13T | | | | | | | |
| 22.00 x 65.50 | P42669 | 42669 | MAZ | VB | | | | | | | |
| 22.00 x 66.00 | P39104 | 37116 | HOL | 202 | 22.00 x 75.00 | P46189 | 43148 | MIT | 4G52 | | |
| | | 39104 | ISU | G161Z | | | 43151 | MIT | 4G53 | | |
| | | 39110 | ISU | G180Z | | | 46138 | TOY | 3F | | |
| | | 39186 | ISU | 6VD1 | | | 46175 | TOY | 5R OLD | | |
| | | 39208 | ISU | G180SR | | | 46177 | TOY | 5R NEW | | |
| | | 39234 | ISU | 6VE1 | | | 46189 | TOY | 18R | | |
| | | 39236 | ISU | G161ZB-II | | | 46201 | TOY | 22R | | |
| | | 39605 | ISU | 4ZA1 | | | 46272 | TOY | 3F NEW | | |
| | | 39654 | ISU | G180Z-II | | | 46294 | TOY | 20R | | |
| | | 39673 | ISU | 6VE1-II | | | 46659 | TOY | 20R-II | | |
| | | 43218 | MIT | 6G72 | | | | | | | |
| | | 46118 | TOY | 1Y | | | | | | | |
| | | 46119 | TOY | 2Y | | | | | | | |
| | | 46120 | TOY | 3Y | | | | | | | |
| | | 46122 | TOY | 4Y | | | | | | | |
| | | | | | | | | | | | |
| | | | | | 22.00 x 79.00 | P43153 | 39119 | ISU | G200Z | | |
| | | | | | | | 39226 | ISU | G200Z-II | | |
| | | | | | | | 43153 | MIT | 4G54 | | |
| | | | | | | | 43233 | MIT | G54B | | |
| | | | | | | | 43273 | MIT | G54BT | | |
| | | | | | | | 43292 | MIT | 4G54C | | |
| | | | | | | | 43654 | MIT | G54B-II | | |



PISTON PIN LIST

| SIZE (DIA X LENGTH) | TEIKIN PIN NUMBER | TEIKIN PISTON NUMBER | ENGINE MODEL | SIZE (DIA X LENGTH) | TEIKIN PIN NUMBER | TEIKIN PISTON NUMBER | ENGINE MODEL |
|------------------------|----------------------|----------------------------|---------------------------|------------------------|----------------------|----------------------------|----------------------------|
| 22.50 x 65.00 | P42221 | 42221 | MAZ MZR 2.3L | 23.01 x 56.50 | P62101 | 62101A-2 | TAT ACE ALFIN |
| | | 42222 | MAZ L3-III | | | 62104A | TAT ACE-II ALFIN |
| 22.89 x 67.50 | P31120 | 31120 | CHR MOT. 201 | 23.07 x 65.40 | PM1102P | M1102P | YAM 115/225 HP |
| 22.89 x 69.00 | P31115 | 31115 | CHR 2.5 L | | | M1102P-6 | YAM 115/225 HP |
| | | | | | | M1103P | YAM 115/225 HP-II |
| 22.89 x 71.50 | P31119 | 31119 31121 | CHR MOT. 232 CHR EGH | | | M1103P-6 | YAM 115/225 HP-II |
| 22.98 x 63.00 | P42163 | 42163 | MAZ G6 | 23.17 x 69.50 | P35183 | 35183 | FOR 140 |
| | | 42169 | MAZ JE-48 | | | | 23.17 x 76.20 |
| 22.99 x 65.00 | P44347 | 44347 | NIS TB45DE/TB48DE | 23.31 x 69.00 | PM2107P | M2107P | MER OPTIMAX 2.5L |
| 23.00 x 56.00 | P34129 | 34129A | FIA PALIO 1.3L JTD ALFIN | 23.50 x 58.00 | P46276 | 46276 | TOY 1N |
| 23.00 x 56.50 | P56605 | 56605A | OPE Y 13 DT/Z 13 DT ALFIN | 23.50 x 65.50 | P58111 | 58111 | GM LLV |
| 23.00 x 58.00 | P55101 | 55101 | SUB EJ22 | | | 58111-5 | GM LLR |
| | | 55654 | SUB EJ20 | 23.64 x 68.50 | P31124 | 31124 | CHR 153 |
| 23.00 x 60.00 | PG1111 | G1111 | YAN TF 65 | | | | 23.81 x 75.00 |
| 23.00 x 60.00 | PG1118 | G1118 | YAN TF 55 | 35168-4 | FOR 40073 | | |
| | | G1120 | YAN TF 65-II | 24.00 x 60.00 | P30113 | 30113 | CHE CAPTIVA 3.2 |
| 23.00 x 62.00 | P55103 | 55103 | SUB EJ25 | | | | 24.00 x 61.00 |
| | | 55104 | SUB EJ25-II | 31122 | CHR EGJ | | |
| | | 55109 | SUB EJ255-III | 46300 | TOY 1RZ | | |
| | | 55655 | SUB EJ20-T-II | 46359 | TOY 1RZ-III | | |
| | | 58108 | GM 191 | 58109 | GM 213/LX9 | | |
| | | 58110 | GM B207R | 24.00 x 63.00 | P44262 | 44262 | |
| 23.00 x 63.00 | P51132 | 51132 | HYU SONATA 3.8L | | | | 24.00 x 64.00 |
| | | 51133 | HYU SONATA 3.3L | 48101A | VW ME ALFIN | | |
| 23.00 x 63.00 | PG1102 | G1102 | YAN TS 60 | 24.00 x 64.00 | P48601 | 48601A | VW 1G / 1V / CYTURBO ALFIN |
| | | G1604 | YAN TS 60-II | | | 48602A | VW 1X / 1Y / AAB ALFIN |
| 23.00 x 64.00 | P55102 | 51139 | HYU G6DB | 24.00 x 65.00 | PG0111 | G0111 | KUB RD 65 |
| | | 55102 | SUB EJ20-T | 24.00 x 65.00 | PG0123 | G0123 | KUB RD 55 |
| | | 55105 | SUB EJ255-T | | | | 24.00 x 68.50 |
| | | 55108 | SUB EJ255-II | 24.00 x 70.00 | P46694 | 46694 | |
| 23.00 x 64.50 | P32602 | 32602 | DAI CL-T | | | | 24.00 x 71.00 |
| | | | | 23.00 x 65.00 | PG2104 | G2104 | |
| 23.00 x 70.00 | P35182 | 35182 | FOR 238 | | | | M3106P-6 |
| | | | | M3106P-8 | JOH LOOPER 3.5000" | | |
| | | | | M3110P | JOH 3.685" | | |
| 23.00 x 74.00 | P67103 | 67103 | PEU 2300 90 | M3110P-6 | JOH 3.685" | | |
| | | | | M3110P-8 | JOH 3.685" | | |
| | | | | M3110P-8 | JOH 3.685" | | |
| 23.00 x 76.00 | P56105 | 44660 | NIS TB42/ E/ S | 24.01 x 70.00 | P46312 | 46311 | TOY 2RZ-FE |
| | | 56105 | OPE 20E CIH | | | 46312 | TOY 3RZ-FE |
| | | 56105-6 | OPE 3.0 E/NE | | | 46313 | TOY 2TZ-FE |
| 23.00 x 77.00 | P42655 | 42655 | MAZ JE | 24.01 x 70.00 | P46312 | 46329 | TOY 2TZ-FE |
| | | | | | | 46344 | TOY 2TZ-FE-II |
| | | | | | | 46375 | TOY 2RZ-FE-III |
| | | | | | | 46607 | TOY 2RZ |
| | | | | | | 23.00 x 80.00 | P39176 |
| 39185 | ISU 4ZE1 | | | | | | |
| 39228 | ISU 4ZD1-II | | | | | | |
| 39604 | ISU 4ZE1-II | | | | | | |
| | | | | | | | |

PISTON PIN LIST

| SIZE (DIA X LENGTH) | TEIKIN PIN NUMBER | TEIKIN PISTON NUMBER | ENGINE MODEL | | SIZE (DIA X LENGTH) | TEIKIN PIN NUMBER | TEIKIN PISTON NUMBER | ENGINE MODEL | | | | |
|------------------------|----------------------|----------------------------|---------------|----------------------|------------------------|----------------------|----------------------------|---------------|-----------------------|---------|----------------------|-----------------------------|
| 24.02 x 59.00 | P31130 | 31130 | CHR | POWER TECH 4.7 | 26.00 x 65.50 | PG1112 | G1112 | YAN | TF 75 | | | |
| | | 31130-6 | CHR | POWER TECH 3.7 | | | | 26.00 x 66.00 | P48603 | 48603A | VW | AAZ / ABL / ADE TURBO ALFIN |
| 25.00 x 58.00 | PG0101 | G0101 | KUB | KND3B | 26.00 x 66.00 | PG1113 | 44624 | | | | NIS | LD20-T |
| 25.00 x 60.00 | P39179 | 39179 | ISU | 4EC1 TURBO | | | G1103 | YAN | TS 70 | | | |
| 25.00 x 60.00 | P39668 | 39668A | ISU | 4EE1 ALFIN | | | G1113 | YAN | TF 85 | | | |
| 25.00 x 64.00 | P42601 | 42601 G0121 | MAZ | PN KUB RD 75 | | | G1115 | YAN | TF 85-II | | | |
| 25.00 x 64.00 | P42674 | 42674AG | MAZ | R2 NEW ALFIN GALLERY | 26.00 x 67.80 | PM1105P | M1105P | YAM | 225/250 HP | | | |
| | | | 25.00 x 65.00 | PG0120 | | | | 31129 | CHR | 370 CID | 26.00 x 68.00 | P44603 |
| | | G0103 | KUB | KND 70A | G0102 | KUB | KND 5B | 26.00 x 70.00 | P32139 | 32102 | | |
| | | G0112 | KUB | JD75 | 32103 | DAI | DG OLD-4R | | | 32126 | DAI | DL |
| | | G0116 | KUB | KND40 | 32128 | DAI | DL NEW-26 | | | 32139 | DAI | DG OLD-5R |
| | | G0120 | KUB | GA70 | 26.00 x 71.00 | P44210 | 29120 | | | MER | M115.923 | |
| 25.00 x 66.00 | P43612 | 43612 | MIT | 4D68T | | | 44210 | | | NIS | SD22 | |
| 25.00 x 67.00 | P39157 | 39157 | ISU | 4FC1 | 44291 | NIS | SD22-II | 26.00 x 73.00 | P29116 | 29116 | MER | M115.952 |
| | | 39183 | ISU | 4FB1 | 44210-6 | NIS | SD33 | | | 29117 | MER | M115.951 |
| | | 43613 | MIT | 4D68 | 26.00 x 74.00 | P44215 | 29118 | MER | 240D | | | |
| | | 44176 | NIS | LD20 | | | 44215 | NIS | SD23 / SD25 | | | |
| | | 44263 | NIS | LD20-II | | | 44266 | NIS | TD23 | | | |
| | | 44602 | NIS | CD20 | | | 44622 | NIS | SD23/25-II | | | |
| | | 44606 | NIS | RD28 | 27.00 x 58.00 | P46260 | 46260 | TOY | 2C | | | |
| | | 44625 | NIS | LD28 | | | 46264 | TOY | 2C-II | | | |
| | | 462103 | MIT | MN 110 | 46278 | TOY | 2C-T | | | | | |
| | | G2106 | MIT | NM90 | 46374 | TOY | 2C-IV | | | | | |
| 25.00 x 68.00 | P42167 | 42167 | MAZ | R2 | 46630 | TOY | 1C-III | | | | | |
| | | 42611 | MAZ | R2 LATE | 46650 | TOY | 1C-II | | | | | |
| | | 43229 | MIT | 4D65T | 46692 | TOY | 1C NEW | | | | | |
| | | 43241 | MIT | 4D65T OLD | 46676AG | TOY | 1ND-TV ALFIN GALLERY | | | | | |
| | | 43264 | MIT | 4D65 | 27.00 x 61.00 | P46609 | 46609 | TOY | 2CT-II | | | |
| | | 43286 | MIT | 4D65-II | | | 27.00 x 61.00 | P46629 | 46629A | TOY | 3C ALFIN | |
| 25.00 x 70.00 | PG0118 | 43687 | MIT | 4DQ5 | 27.00 x 64.00 | P39189 | | | 39189 | ISU | 4EE1-T | |
| | | 62103A | TAT | 207 ALFIN | | | 56606A | OPE | Y 17 DT/DTL ALFIN | | | |
| | | G0104 | KUB | KND 80 | 27.00 x 66.00 | P46695 | 46695AG | TOY | 2CT-III ALFIN GALLERY | | | |
| | | G0106 | KUB | KND 85 | | | 27.00 x 67.00 | P44623 | 44623AG | NIS | RD28-T ALFIN GALLERY | |
| | | G0113 | KUB | GA80 | | | | | 27.00 x 68.00 | P39130 | 39128 | ISU |
| | | G0118 | KUB | RD 85 | | | 39130 | ISU | | | C-223 | |
| G0124 | KUB | RD 85S | 39159 | ISU | 4FD1 | | | | | | | |
| 25.00 x 72.50 | P39620 | 39620 | ISU | C-221-II | 39218 | ISU | C-223-II | | | | | |
| | | 25.15 x 71.80 | P46136 | 46136 46623 | TOY | 2F TOY 2F-II | 39601 | ISU | C-223 OLD | | | |
| 25.15 x 80.00 | P46132 | 46132 | TOY | F | 39602 | ISU | 4FG1 | | | | | |
| 25.40 x 75.90 | P40103 | 40103 | LAN | 3.562 | 39621 | ISU | C-240 | | | | | |
| 26.00 x 55.00 | P29603 | 29603A | MER | OM 601 ALFIN | 46112 | TOY | 1C | | | | | |
| 26.00 x 62.00 | P29602 | 29602A | MER | OM 661 ALFIN | 46601 | TOY | 2C-III | | | | | |
| 26.00 x 62.70 | P46270 | 44295 | NIS | LD23 | 46684 | TOY | 1DZ NEW | | | | | |
| | | 46270 | TOY | 1FZ-FE | 46654A | TOY | 1DZ ALFIN | | | | | |
| | | 46282 | TOY | 1FZ-FE-II | | | | | | | | |
| | | 46372 | TOY | 1FZ-FE-III | | | | | | | | |

PISTON PIN LIST

| SIZE (DIA X LENGTH) | TEIKIN PIN NUMBER | TEIKIN PISTON NUMBER | ENGINE MODEL | | SIZE (DIA X LENGTH) | TEIKIN PIN NUMBER | TEIKIN PISTON NUMBER | ENGINE MODEL | | | | |
|---------------------|-------------------|----------------------|---------------|----------------------------|---------------------|-------------------|-------------------------|----------------|-------------------------------|---------------|---------------------------|----------|
| 27.00 x 70.00 | P46261 | 46261 | TOY | 2L-II | 29.00 x 69.00 | P46678 | 46678AG | TOY | 1AD-FTV ALFIN GALLERY | | | |
| | | 46351A | TOY | 2LT NEW-II ALFIN | | | 46679AG | TOY | 2AD-FHV ALFIN GALLERY | | | |
| 27.00 x 72.00 | P39125 | 39125 | ISU | C-240 OLD | 29.00 x 74.00 | P46256 | 46256 | TOY | 3L | | | |
| | | 39127 | ISU | C-190 | | | 46273 | TOY | 5L | | | |
| | | G0107 | KUB | KND 105 | | | 46600 | TOY | 2LT LATE | | | |
| | | G0108 | KUB | KND 110 | | | 46602 | TOY | 2L-T | | | |
| | | G0119 | KUB | KND 95Di | | | 46611 | TOY | 2H LATE | | | |
| 27.00 x 74.00 | P46240 | 46226 | TOY | 2J | 29.00 x 75.00 | P43171 | 35102 | FOR | 2402 E | | | |
| 46234 | | TOY | L OLD | 43171 | | | MIT | 4D55/4D56 | | | | |
| 46236 | | TOY | L NEW | 43173 | | | MIT | 4D56T | | | | |
| 46238 | | TOY | L NEW-II | 43285 | | | MIT | 4D56-II | | | | |
| 46240 | | TOY | 2L | 43291 | | | MIT | 4D56 LATE | | | | |
| 46316 | | TOY | H-II | 43661 | | | MIT | 4D56-T LATE-II | | | | |
| 46369 | | TOY | 2J-III | 46231 | | | TOY | 2H | | | | |
| 46226-6 | TOY | H NEW | 51102 | HYU | D4BB | | | | | | | |
| 28.00 x 61.00 | P44671 | 44671AG | NIS | YD25TDI ALFIN GALLERY | 29.00 x 77.00 | P36101 | 36101 | HIN | DM-100 | | | |
| | | 51142AG | HYU | i20 MAGNA CDRALFIN GALLERY | | | 35601A | FOR | 4A B/ BA / BB / CA / FA ALFIN | | | |
| 28.00 x 61.50 | P44685 | 44685AG | NIS | YD22DDT/ETI ALFIN GALLERY | | | 29.00 x 79.00 | P46123 | 46123 | TOY | B OLD | |
| | | 51604A | HYU | D3EA ALFIN | | | | | 46124 | TOY | B NEW | |
| 28.00 x 65.50 | P51604 | 51604A-4 | HYU | D4EA ALFIN | | | 46127 | TOY | 2B | 46265 | TOY | BU 15-II |
| | | 44681AG | NIS | CD20-T ALFIN GALLERY | | | 46308 | TOY | B NEW-II | 30.00 x 68.00 | P42610 | 42610AG |
| 28.00 x 69.00 | P44697 | 44697AG | NIS | YD22DDT/DDTIALFIN GALLERY | | | 30.00 x 68.00 | P42671 | 42671A | | | MAZ |
| 28.00 x 70.00 | PG1114 | 29604AG | MER | OM 602 TURBOALFIN GALLERY | | | 30.00 x 68.00 | P42675 | 42675AG | MAZ | RF7 ALFIN GALLERY | |
| | | G1114 | YAN | TF 105 | | | 30.00 x 69.00 | P38661 | 38661AG | HON | N22A1/N22A2 ALFIN GALLERY | |
| 28.00 x 71.00 | P44684 | 44684AG | NIS | YD25TDI NEWALFIN GALLERY | | | 30.00 x 70.00 | P38658 | 38658A | HON | 20T2N/20T2 TURBO ALFIN | |
| | | 44686AG | NIS | YD25DDTI ALFIN GALLERY | | | 30.00 x 73.00 | PG1105 | G1105 | YAN | TS 130 | |
| | | G1601 | YAN | TS 105-II | | | 30.00 x 74.00 | P44630 | 44630 | NIS | TD27-LATE | |
| 28.00 x 71.00 | PG1104 | G1104 | YAN | TS 105 | | | 44630-6 | NIS | TD42-LATE | | | |
| 28.00 x 72.00 | P51605 | 51605AG | HYU | D4EB-F/D4EB-GALFIN GALLERY | | | 30.00 x 74.00 | P44666 | 64601 | KOM | 4D95 ALFIN | |
| 28.00 x 73.50 | P42174 | 42174 | MAZ | S2 | 44666A | NIS | TD25 LATE ALFIN | | | | | |
| | | 42606 | MAZ | S5 | 30.00 x 75.00 | P52650 | 42657 | MAZ | JS K2700 | | | |
| | | 42659 | MAZ | XA-II | | | 52650A | KIA | RFA ALFIN | | | |
| 28.00 x 74.00 | PG0114 | G0114 | KUB | GA 90 | 30.00 x 76.50 | P43682 | 43682 | MIT | S4S | | | |
| | | 32127 | DAI | DL NEW-28 | | | 43682-6 | MIT | S6S | | | |
| 28.00 x 74.80 | P32127 | 42658 | MAZ | SF K2400 | 30.00 x 78.00 | P43232 | 43232 | MIT | 4M40-T | | | |
| 28.00 x 76.80 | P43157 | 43157 | MIT | 4DR5 | | | 43610 | MIT | 4DR7 | | | |
| | | 68101A | TEM | TRAVELLER ALFIN | 43670AG | MIT | 4M40-T-II ALFIN GALLERY | | | | | |
| | | 43609 | MIT | S4E | 43673A | MIT | 4M40 ALFIN | | | | | |
| 28.00 x 77.00 | P43609 | 43655 | MIT | S4E2 | 52651A | KIA | JT 3.0 ALFIN | | | | | |
| | | 43688 | MIT | S4E2 | 29.00 x 65.00 | P46257 | 46257 | TOY | 1HZ | | | |
| | | 44255 | NIS | TD25 | | | 29.00 x 68.00 | P39609 | 39609 | ISU | C-223-T | |
| 44267 | NIS | TD27 | 29.00 x 65.00 | P46257 | 46257 | TOY | | | 1HZ | | | |
| 44267-6 | NIS | TD42 | | | 29.00 x 68.00 | P39609 | 39609 | ISU | C-223-T | | | |

PISTON PIN LIST

| SIZE (DIA X LENGTH) | TEIKIN PIN NUMBER | TEIKIN PISTON NUMBER | ENGINE MODEL | | SIZE (DIA X LENGTH) | TEIKIN PIN NUMBER | TEIKIN PISTON NUMBER | ENGINE MODEL | |
|---------------------|-------------------|----------------------|--------------|------------------------------|---------------------|------------------------|-------------------------|--------------------|----------------------------|
| 30.00 x 79.80 | P44296 | 44296 | NIS | TD27-T - II | 32.00 x 85.00 | P44670 | 44670 | NIS | ED30 |
| | | 44619 | NIS | BD30 | | | | | |
| | | 44621AG | NIS | TD27-T ALFIN GALLERY | 33.00 x 73.00 | P46674 | 46674AG | TOY | 1HD-FTE ALFIN GALLERY |
| | | 44621 AG-6 | NIS | TD42-T ALFIN GALLERY | | | | | |
| | | 44654AG | NIS | BD30T ALFIN GALLERY | | | | | |
| | | 44674AG | NIS | TD27-T NEW ALFIN GALLERY | | | | | |
| 30.00 x 80.00 | P44654 | G0105 | KUB | KND 90/120 | 33.00 x 78.00 | P44297 | 44297 | NIS | QD32 |
| | | | | | | | 44672AG | NIS | ZD30 ALFIN GALLERY |
| 31.00 x 68.00 | P46680 | 46680AG | TOY | 1CD-FTV ALFIN GALLERY | | | 44673AG | NIS | ZD30 LATE ALFIN GALLERY |
| | | 46690AG | TOY | 1CD-FTV-II ALFIN GALLERY | | | 44678AG | NIS | ZD30DDT ALFIN GALLERY |
| 31.00 x 76.00 | P39232 | 39231 | ISU | 4JA1T NEW | | | 44702AG | NIS | ZD30DD ALFIN GALLERY |
| | | 39232AG | ISU | 4JH1-TC ALFIN GALLERY | | | 33.00 x 79.00 | P44683 | 44683AG |
| | | 39658A | ISU | 4JA1 LATE ALFIN | | | | | |
| | | 39661AG | ISU | 4JX1 ALFIN GALLERY | 33.00 x 83.00 | P39165 | 39165 | ISU | 4BC1 |
| 31.00 x 77.00 | P39162 | 39162 | ISU | 4JA1 | | | | 33.00 x 85.00 | P39160 |
| | | 39163 | ISU | 4JB1 | | | | | |
| | | 39656A | ISU | 4JB1 LATE ALFIN | | | | | |
| 31.50 x 81.50 | P36603 | 36603 | HIN | EC100 | 33.01 x 73.00 | P46268 | 46268 | TOY | 1HD-T LATE |
| 31.75 x 75.00 | P42149 | 42149 | MAZ | HA | | | 46325 | TOY | 1HD-T-II |
| | | 42150 | MAZ | XB | 46362AG | TOY | 1HD-FT ALFIN GALLERY | | |
| | | 42179 | MAZ | ZB | | | | | |
| | | 42198 | MAZ | SS K2700 | | | | | |
| | | 42605 | MAZ | XA | 34.00 x 65.00 | P46348 | 46348AG | TOY | 2KD - FTV ALFIN GALLERY |
| | | 42150-6 | MAZ | ZB OLD | | | | | |
| | | G8102 | PER | 68322 (NEW) | | | | | |
| | | | | | | | | | |
| 32.00 x 70.00 | P42185 | 42185 | MAZ | WL-T | 34.00 x 70.00 | P42212 | 42212AG | MAZ | MZ-DE ALFIN GALLERY |
| | | 42186 | MAZ | WL | | | 42213AG | MAZ | MZR-CD ALFIN GALLERY |
| | | 42215AG | MAZ | W9 ALFIN GALLERY | 34.00 x 73.00 | P46283 | 46283 | TOY | 1KZ-TE |
| 32.00 x 72.00 | P46254 | 46254 | TOY | 14B | | | 46655A | TOY | 15BF ALFIN |
| | | 46608 | TOY | 11B-II | | | 46656AG | TOY | 15BF-T ALFIN GALLERY |
| | | 46622 | TOY | 3B-II | | | 46671AG | TOY | 1KZ-TE NEW ALFIN GALLERY |
| 32.00 x 75.00 | P43672 | 43672AG | MIT | 4D55T/4D56T-II ALFIN GALLERY | | | 46675AG | TOY | 1KD-FTV ALFIN GALLERY |
| | | 43678AG | MIT | 4D56T CDRI ALFIN GALLERY | | | 46686AG | TOY | 1KD-FTV-II ALFIN GALLERY |
| 32.00 x 76.00 | P46613 | 46613 | TOY | 1Z | | | 46698AG | TOY | 1KD-FTV-III ALFIN GALLERY |
| | | 46624 | TOY | 12H-T | 65001A | EIC | 4D31 ALFIN | | |
| | | 66101A | MAH | SCORPIO CRD ALFIN | 34.00 x 76.00 | P46287 | 46287 | TOY | 11B |
| 32.00 x 77.00 | P46682 | 46682 | TOY | 2Z NEW | | | | 34.00 x 78.00 | P39188 |
| | | 46685 | TOY | 13Z | 39190 | ISU | 4JB1-T LATE | | |
| 32.00 x 78.00 | P52107 | 43663AG | MIT | 4M41-T ALFIN GALLERY | 39600 | ISU | 4JG2 EARLY | | |
| | | 52107AG | KIA | CARNIVAL-II ALFIN GALLERY | 39608AG | ISU | 4JG2-T ALFIN GALLERY | | |
| 32.00 x 79.80 | PG1116 | G1116 | YAN | TF 155 | 39669AG | ISU | 4JG2-T-II ALFIN GALLERY | | |
| | | 32.00 x 80.00 | PG1106 | 43681AG | MIT | 4M42-0AT ALFIN GALLERY | 39674AG | ISU | 4JJ1-TC CRDI ALFIN GALLERY |
| G1106 | YAN | | | TS 155 | 39675AG | ISU | 4JK1-TC ALFIN GALLERY | | |
| G1107 | YAN | | | TS 180 | 34.00 x 78.00 | P39660 | 39660AG | ISU | 4JG2-T NEW ALFIN GALLERY |
| 32.00 x 80.80 | PG1602 | G1602 | YAN | TS 180-II | | | | 34.00 x 79.00 | P46625 |
| | | 32.00 x 82.00 | P43115 | 43115 | MIT | 6DS7 | 34.00 x 79.00 | | |
| 43115N | MIT | | | 6DS7 NEW | 34.00 x 81.00 | P65002 | | 65002A | EIC |
| 32.00 x 83.40 | P46128 | 34118 | FIA | TRACTOR 300, 350, 355 | | | 34.00 x 82.00 | | P42107 |
| | | 46128 | TOY | 3B | 42201 | MAZ | | SL-III | |
| | | | | | 42613AG | MAZ | | SL-T ALFIN GALLERY | |
| 32.00 x 82.00 | P52652 | 52652A | KIA | JD K3500 ALFIN | 34.00 x 82.00 | P42107 | 52653G | KIA | SH K3600 GALLERY |
| | | | | | | | 52656G | KIA | SH K3600 NEW-II GALLERY |
| | | 32.00 x 83.50 | P39138 | 39137 | ISU | DA-120-4R | 34.00 x 82.00 | P52652 | 52652A |
| 39138 | ISU | | | DA-120-5R | | | | | |
| 43164 | MIT | | | 4D30 OLD | | | | | |

PISTON PIN LIST

| SIZE (DIA X LENGTH) | TEIKIN PIN NUMBER | TEIKIN PISTON NUMBER | ENGINE MODEL | | SIZE (DIA X LENGTH) | TEIKIN PIN NUMBER | TEIKIN PISTON NUMBER | ENGINE MODEL | | | | | | | | |
|------------------------|----------------------|----------------------------|------------------|---------------------------|------------------------|----------------------|---|---------------|----------------------------|---------------|-------------------------|---------------|--------|---------------|--------|--------|
| 34.00 x 83.50 | P39138 | 43166 | MIT | 4D30 | 35.00 x 85.00 | P39166 | 39180 | ISU | 4BE1 | | | | | | | |
| | | 43168 | MIT | 4D31/4D31T | | | 39612 | ISU | 4BE1-II | | | | | | | |
| | | 43170 | MIT | 4D34 | | | 36651A | HIN | W06D ALFIN | | | | | | | |
| | | 43227 | MIT | 4D32 | | | 36656A | HIN | W06E ALFIN | | | | | | | |
| | | 43244 | MIT | 4D33 | | | 63101A | ALY | 6ET1ALFIN | | | | | | | |
| | | 43280 | MIT | 4D36 | | | 35.00 x 87.00 P39667 39667A ISU 6BD1-T ALFIN | | | | | | | | | |
| | | 43619 | MIT | 4D32 LATE | | | 35.00 x 87.40 P39611 39611AG ISU 4BD2-T ALFIN GALLERY | | | | | | | | | |
| | | 43666 | MIT | 4D32 NEW | | | 35.00 x 87.50 P39149 39148 ISU 6BB1 | | | | | | | | | |
| | | 44620 | NIS | FD35 | | | 39149 ISU 6BD1 | | | | | | | | | |
| | | 46130 | TOY | 13B | | | 39151 ISU 6BD1-II | | | | | | | | | |
| | | 51103 | HYU | D4AF | | | 39182 ISU 6BG1 | | | | | | | | | |
| | | 51112 | HYU | D4AE | | | 39184 ISU 4BD1-III | | | | | | | | | |
| | | 39137-4 | ISU | DA220 | | | 39614 ISU 6BG1-T | | | | | | | | | |
| | | 43168-6 | MIT | 6D31 / 6D31T | | | 39616 ISU 6BF1 | | | | | | | | | |
| | | 44323A | NIS | FD6T ALFIN | | | 39618 ISU 4BD1-T | | | | | | | | | |
| | | 44657A | NIS | FD6T-II ALFIN | | | 42183 MAZ TF | | | | | | | | | |
| 44658A | NIS | FD6T-III ALFIN | 39148-4 ISU 4BB1 | | | | | | | | | | | | | |
| 34.00 x 84.00 | P43617 | 43617 | MIT | 4D31 T | 35.00 x 95.00 | PG0109 | G0109 | KUB | KND 180 | | | | | | | |
| | | 44605 | NIS | ED33 | | | G0110 | KUB | KND 190 | | | | | | | |
| 34.00 x 84.00 | P43664 | 43664A | MIT | 4D31-T LATE ALFIN | G0115 | KUB | KND 220 | 36.00 x 79.00 | P39181 | 39181 | ISU | 4HF1 | | | | |
| 34.00 x 84.00 | P43674 | 43674A | MIT | 4M51 ALFIN | G0117 | KUB | KND 250 | | | 39187 | ISU | 4HF1-II | | | | |
| 34.00 x 84.00 | P43683 | 43683 | MIT | 4M51T | 36.00 x 79.00 | P39670 | 39670AG | ISU | 4HL1 ALFIN GALLERY | | | | | | | |
| 34.00 x 85.00 | P44629 | 44659 | NIS | FD35-T | | | 39676AG | ISU | 4HG1-T ALFIN GALLERY | | | | | | | |
| | | 44629A | NIS | FD33-T ALFIN | | | 36.00 x 82.50 P29110 29110 MER OM - 352 | | | | | | | | | |
| | | 44694A | NIS | ED35 ALFIN | | | 36.00 x 86.50 P39142 39142 ISU DA-640 | | | | | | | | | |
| 34.00 x 85.00 | P44698 | 44698A | NIS | FD33 ALFIN | | | 36.00 x 88.00 | P43608 | 43605 | MIT | 4D34T | | | | | |
| 34.00 x 88.50 | P46242 | 36111 | HIN | EH-100 | | | | | 43608 | MIT | 4D35 | | | | | |
| | | 46242 | TOY | 2D OLD | | | | | 43293AG | MIT | 4D34T NEW ALFIN GALLERY | | | | | |
| | | 46244 | TOY | 2D NEW | | | 43605-6 | MIT | 6D34T | | | | | | | |
| 34.93 x 82.50 | P50101 | 50101 | LEY | 4.98 NV | | | 43691AG | MIT | 4D35 / 4D35T ALFIN GALLERY | 36.00 x 89.30 | PG1109 | G1109 | YAN | TS 230 | | |
| 34.93 x 84.00 | PG8101 | G8101 | PER | 6.354 | | | 43693A | MIT | 4D34T-II ALFIN | | | 36.00 x 89.50 | PG1108 | G1108 | YAN | TS 190 |
| 34.93 x 84.00 | PG8101 | G8103 | PER | 4.248 | | | 51602AG | HYU | D4DA ALFIN GALLERY | | | | | 36.00 x 90.00 | P44692 | 44692A |
| 34.93 x 84.00 | PG8104 | G8104 | PER | 4.236, A 4.236 | | | 36.00 x 92.00 P44667 44667A NIS FE6 ALFIN | | | 36.00 x 92.50 | P44261 | | | 44261 | NIS | FE6T |
| 34.93 x 85.80 | P35101 | 35101 | FOR | THAMES | | | 36.00 x 92.50 P44261 44261 NIS FE6T | | | | | | | | | |
| 34.93 x 88.00 | P28108p | 28101 | BED | 103 | | | 36.00 x 92.50 P44261 44261 NIS FE6T | | | | | | | | | |
| | | 28109 | BED | 103-II NATURAL GAS ENGINE | | | | | | | | | | | | |
| 34.93 x 90.00 | P28108 | 28108 | BED | 104 | | | | | | | | | | | | |
| 35.00 x 79.00 | P42663 | 42663AG | MAZ | TM ALFIN GALLERY | | | | | | | | | | | | |
| 35.00 x 80.00 | PG1110 | G1110 | YAN | 2T | | | | | | | | | | | | |
| | | G1119A | YAN | 3T ALFIN | | | | | | | | | | | | |
| | | 35.00 x 80.00 | PG1110 | G3101 | DON | 95MM 5R | | | | | | | | | | |
| | | | | G3104 | DON | 1100 MM | | | | | | | | | | |
| | | | | G3105 | DON | 95MM 4R | | | | | | | | | | |
| G7101 | DEU | | | F1-912 | | | | | | | | | | | | |
| 35.00 x 85.00 | P39166 | 36653 | HIN | W04D | | | | | | | | | | | | |
| | | 36658 | HIN | W04D LATE | | | | | | | | | | | | |
| | | 39166 | ISU | 4BC2 | | | | | | | | | | | | |

PISTON PIN LIST

| SIZE (DIA X LENGTH) | TEIKIN PIN NUMBER | TEIKIN PISTON NUMBER | ENGINE MODEL | | SIZE (DIA X LENGTH) | TEIKIN PIN NUMBER | TEIKIN PISTON NUMBER | ENGINE MODEL | | |
|------------------------|----------------------|----------------------------|--------------|----------------------|------------------------|----------------------|----------------------------|--------------|------------------------------|-----|
| 36.00 x 92.50 | P44261 | 44618 | NIS | FD46 | 39.00 x 90.00 | P36113 | 36124 | HIN | H07C NEW | |
| | | 44344A | NIS | FE6T-II ALFIN | | | 36125 | HIN | H07C OLD | |
| | | 44348A | NIS | FE6-TC ALFIN | | | 36129AG | HIN | H07C-T ALFIN GALLERY | |
| | | 44656A | NIS | FE6TA ALFIN | | | 36133A | HIN | H06CT/CTL-II ALFIN | |
| 36.00 x 93.00 | P44665 | 44665AG | NIS | FD42 ALFIN GALLERY | | | 36135A | HIN | H06CTE ALFIN | |
| 36.00 x 94.50 | P44244 | 44244 | NIS | ND6 | | | 36136A | HIN | H06CTB ALFIN | |
| | | 44246 | NIS | NE6 | | | 36137AG | HIN | H06CTI/CTL-III ALFIN GALLERY | |
| | | G3106 | DON | 1110 MM | | | 36655AG | HIN | H07C-T-II ALFIN GALLERY | |
| 36.51 x 90.00 | P28107 | 28107 | BED | 107 | 40.00 x 84.00 | P64602 | 64602A | KOM | 4D105 ALFIN | |
| 37.00 x 84.50 | P36657 | 36657-6 | HIN | J08C | 40.00 x 87.00 | P39663 | 39663AG | ISU | 6HE1-T ALFIN GALLERY | |
| | | 36657A | HIN | J05C ALFIN | | | 39671AG | ISU | 4HK1-TC-II ALFIN GALLERY | |
| 37.00 x 84.50 | P46339 | 46339 | TOY | RINO | 40.00 x 87.00 | P39664 | 39664AG | ISU | 4HE1-TC ALFIN GALLERY | |
| 37.00 x 85.00 | P36127 | 36127 | HIN | H07D | 40.00 x 87.00 | P39665 | 39665AG | ISU | 6HK1-TC ALFIN GALLERY | |
| | | 36660A | HIN | W04CT ALFIN | | | 39677AG | ISU | 6HL1-TC ALFIN GALLERY | |
| | | 36661A | HIN | W06DT ALFIN | | | | | | |
| | | 46381A | TOY | S05C-II ALFIN | | | | | | |
| | | 63102A | ALY | 6DTI ALFIN | | | | | | |
| 37.00 x 85.00 | P36659 | 36659AG | HIN | J08C-T ALFIN GALLERY | 40.00 x 87.00 | P39666 | 39666AG | ISU | 4HE1-T ALFIN GALLERY | |
| | | 36659AG-4 | HIN | J05C-T ALFIN GALLERY | 40.00 x 95.00 | P43107 | 43107 | MIT | 6DB NEW | |
| | | 36659AG-5 | HIN | J07C-T ALFIN GALLERY | 42.00 x 98.00 | P36128 | 36128 | HIN | EM 100 | |
| 38.00 x 80.00 | P39606 | 39606 | ISU | 6SA1 | 43.00 x 80.00 | P39626 | 39626 | ISU | 10PD1 | |
| | | 39662A | ISU | PA1 ALFIN | 43.00 x 89.50 | P39623 | 39623 | ISU | 6SD1 | |
| 38.00 x 80.00 | P39615 | 39615AG | ISU | 6SA1-T ALFIN GALLERY | 45.00 x 97.50 | P39617 | 39617 | ISU | DH100 | |
| 38.00 x 80.00 | P39625 | 39625 | ISU | 10PC1 | 45.00 x 100.00 | P36601 | 36601 | HIN | EB300 | |
| 38.00 x 90.00 | P43102 | 43102 | MIT | 6D14 | 45.00 x 108.00 | P43618 | 43618 | MIT | 8DC8 | |
| | | 43104 | MIT | 6D15 | 46.00 x 106.00 | P39657 | 39657A | ISU | 6QA1 ALFIN | |
| | | 43289 | MIT | 6D14.A | 46.00 x 107.00 | P44236 | 44236 | NIS | PD6 | |
| | | 43615 | MIT | 6D14-T | 46.00 x 108.00 | P44679 | 44679A | NIS | PD6-T ALFIN | |
| | | 43283A | MIT | 6D15-II ALFIN | 46.00 x 116.00 | P44242 | 44242 | NIS | RD8 | |
| | | 43665A | MIT | 6D14-T.2A ALFIN | | | 44290 | NIS | RF8 | |
| | | 43668A | MIT | 6D14-T-II ALFIN | | | 44264A | NIS | RE8 ALFIN | |
| | | G2102 | MIT | MN 240 | | | 44264A-10 | NIS | RE10 ALFIN | |
| 38.00 x 90.00 | P43684 | 43684A | MIT | 6D14.3AT ALFIN | 44290-10 | NIS | RF10 | | | |
| | | 43686A | MIT | 6D15-III ALFIN | 44330A | NIS | PE6-T ALFIN | | | |
| 38.00 x 92.00 | P43675 | 43675A | MIT | 6D15.3AT ALFIN | 44655A | NIS | PE6 ALFIN | | | |
| 38.00 x 92.50 | P43105 | 43105 | MIT | 6D16 | 48.00 x 106.00 | P36112 | 36112 | HIN | ED-100 | |
| | | 43223 | MIT | 6D16-T | 48.00 x 108.00 | P29106 | 29106 | MER | OM - 355 | |
| | | 43267 | MIT | 6D17-1A | 50.00 x 105.00 | P39624 | 39624 | ISU | 6RB1 | |
| | | 43265A | MIT | 6D16-1AT2 ALFIN | 50.00 x 105.00 | P43274 | 43274 | MIT | 6D22-T | |
| | | 43266A | MIT | 6D16-2A ALFIN | | | 43614 | MIT | 6D22 | |
| | | 43268A | MIT | 6D16-1A ALFIN | | | 50.00 x 110.00 | P36650 | 36650A | HIN |
| | | 44320A | NIS | NE6T ALFIN | | | 36654A | HIN | EF750 ALFIN | |
| 38.00 x 93.00 | P43685 | 43685AG | MIT | 4M50T ALFIN GALLERY | 50.00 x 111.50 | P43275 | 43275A | MIT | 8DC91-T ALFIN | |
| 38.00 x 93.00 | P43695 | 43695AG | MIT | 6M61 ALFIN GALLERY | 50.00 x 112.00 | P43659 | 43659A | MIT | 8DC11 ALFIN | |
| 38.00 x 98.00 | PG1117 | G1117 | YAN | TF 300 | 50.00 x 112.00 | P43660 | 43660A | MIT | 8DC9 ALFIN | |
| 39.00 x 87.50 | P36652 | 36652A | HIN | H06BT ALFIN | | | | | | |
| 39.00 x 90.00 | P36113 | 36113 | HIN | EH-700 | | | | | | |



PISTON RING LIST



PISTON RING LIST

| TEIKIN RING NUMBER | SIZE | | | | | TEIKIN PISTON NUMBER | ENGINE MODEL | |
|--------------------|-------------|-----|-----|-----|-----|-------------------------|-------------------|--------------------------------|
| | RING GROOVE | | | OIL | | | | |
| | 1 | 2 | 3 | 1 | 2 | | | |
| R29110 | 3.0 FK | 3.0 | 3.0 | 5.5 | 5.5 | 29110 | MER | 911, OM - 352 |
| R29118 | 3.0 | 2.0 | | 4.0 | | 29118 | MER | 240D |
| R29602 | 2.5 | 2.0 | | 3.0 | | 29602A | MER | OM 661 |
| R29603 | 2.5 | 2.0 | | 3.0 | | 29603A | MER | OM 601 |
| R29604 | 2.5 | 2.0 | | 3.0 | | 29604AG | MER | OM 602 TURBO |
| R32102 | 2.5 | 2.0 | | 4.0 | | 32102 | DAI | DG |
| R32103 | 2.0 | 2.0 | 2.0 | 4.0 | | 32103 | DAI | DG OLD-4R |
| R32120 | 2.0 HK | 1.5 | | 3.0 | | 32120 32602 | DAI DAI | CL CL-T |
| R32126 | 2.5 | 2.0 | | 4.0 | | 32126 32127 32128 | DAI DAI DAI | DL DL NEW-28 DL NEW-26 |
| R32139 | 2.0 | 2.0 | 2.0 | 4.0 | 4.0 | 32139 | DAI | DV26 5R |
| R34129 | 2.0 | 1.5 | | 2.0 | | 34129A | FIA | PALIO 1.3L JTD |
| R35601 | 2.5 FK | 2.0 | | 4.0 | | 35601A | FOR | 4A B/ BA / BB / CA / FA |
| R36101 | 2.5 | 2.5 | 2.5 | 4.0 | 4.0 | 36101 | HIN | DM-100 |
| R36111 | 2.5 | 2.5 | 2.5 | 4.0 | 4.0 | 36111 | HIN | EH-100 |
| R36113 | 3.0 | 2.5 | 2.5 | 5.0 | | 36113 36124 36125 | HIN HIN HIN | EH-700 H07C NEW H07C OLD |
| R36127 | 3.0 | 2.0 | | 4.0 | | 36127 | HIN | H07D |
| R36128 | 2.8 FK | 2.5 | 3.0 | 5.0 | | 36128 | HIN | EM 100 |
| R36129 | 2.8 FK | 2.0 | 2.0 | 4.0 | | 36129AG | HIN | H07C-T |
| R36135 | 3.0 FK | 2.5 | 2.5 | 5.0 | | 36135A 36136A | HIN HIN | H06CTE H06CTB |
| R36601 | 3.5 | 3.5 | 3.5 | 6.0 | | 36601 | HIN | EB300 |
| R36603 | 2.5 | 2.5 | 2.5 | 4.0 | 4.0 | 36603 | HIN | EC100 |
| R36650 | 3.3 FK | 3.5 | 3.5 | 6.0 | | 36650A | HIN | EK100 |



PISTON RING LIST

| TEIKIN RING NUMBER | SIZE | | | | | TEIKIN PISTON NUMBER | ENGINE MODEL | |
|--------------------|-------------|-----|-----|-----|---|----------------------|--------------|------------------|
| | RING GROOVE | | | OIL | | | | |
| | 1 | 2 | 3 | 1 | 2 | | | |
| R36651 | 2.5 | 2.0 | | 5.0 | | 36651A | HIN | W06D |
| | | | | | | 36656A | HIN | W06E |
| R36652 | 2.8 HK | 2.5 | 2.5 | 5.0 | | 36652A | HIN | H06BT |
| R36653 | 2.5 | 2.0 | | 5.0 | | 36653 | HIN | W04D |
| | | | | | | 36658 | HIN | W04D LATE |
| R36654 | 3.5 FK | 3.5 | 3.5 | 6.0 | | 36654A | HIN | EF750 |
| R36655 | 2.8 FK | 2.0 | 2.5 | 4.0 | | 36655AG | HIN | H07C-T-II |
| R36657 | 3.0 | 2.0 | | 4.0 | | 36657A | HIN | J05C |
| R36657-6 | 3.0 | 2.0 | | 4.0 | | 36657-6 | HIN | J08C |
| R36659 | 2.5 | 2.0 | | 4.0 | | 36659AG | HIN | J08C-T |
| R36659-4 | 2.5 | 2.0 | | 4.0 | | 36659AG-4 | HIN | J05C-T |
| R36659-5 | 2.5 | 2.0 | | 4.0 | | 36659AG-5 | HIN | J07C-T |
| R36660 | 3.0 FK | 2.5 | | 5.0 | | 36660A | HIN | W04CT |
| R36661 | 2.8 FK | 2.5 | | 5.0 | | 36661A | HIN | W06DT |
| R38658 | 3.0 FK | 2.0 | | 3.0 | | 38658A | HON | 20T2N/20T2 TURBO |
| R39125 | 2.0 | 2.0 | 2.0 | 5.0 | | 39125 | ISU | C-240 OLD |
| | | | | | | 39127 | ISU | C-190 |
| R39128 | 2.5 | 2.0 | | 5.0 | | 39128 | ISU | C-190-3R |
| | | | | | | 39621 | ISU | C-240 |
| R39130 | 2.0 | 2.0 | | 4.0 | | 39130 | ISU | C-223 |
| R39137 | 2.5 | 2.5 | 2.5 | 5.0 | | 39137 | ISU | DA-120-4R |
| R39137-4 | 2.5 | 2.5 | 2.5 | 5.0 | | 39137-4 | ISU | DA220 |
| R39142 | 2.5 | 2.5 | 2.5 | 5.0 | | 39142 | ISU | DA-640 |
| R39148 | 3.0 | 2.5 | | 5.0 | | 39148 | ISU | 6BB1 |
| | | | | | | 39149 | ISU | 6BD1 |
| | | | | | | 39151 | ISU | 6BD1-II |
| | | | | | | 39667A | ISU | 6BD1-T |
| R39157 | 2.5 | 2.0 | | 4.0 | | 39157 | ISU | 4FC1 |
| | | | | | | 39183 | ISU | 4FB1 |



PISTON RING LIST

| TEIKIN RING NUMBER | SIZE | | | | | TEIKIN PISTON NUMBER | ENGINE MODEL | |
|--------------------|-------------|-----|---|-----|---|----------------------|--------------|-------------|
| | RING GROOVE | | | OIL | | | | |
| | 1 | 2 | 3 | 1 | 2 | | | |
| R39159 | 2.0 | 2.0 | | 4.0 | | 39159 | ISU | 4FD1 |
| R39160 | 3.0 | 2.5 | | 5.0 | | 39160 | ISU | 4BA1 |
| R39162 | 2.0 | 2.0 | | 4.0 | | 39162 | ISU | 4JA1 |
| | | | | | | 39163 | ISU | 4JB1 |
| | | | | | | 39188 | ISU | 4JB1-T |
| | | | | | | 39190 | ISU | 4JB1-T LATE |
| | | | | | | 39231 | ISU | 4JA1T NEW |
| | | | | | | 39656A | ISU | 4JB1 LATE |
| | | | | | | 39658A | ISU | 4JA1 LATE |
| R39165 | 3.0 | 2.5 | | 5.0 | | 39165 | ISU | 4BC1 |
| | | | | | | 39166 | ISU | 4BC2 |
| | | | | | | 39618 | ISU | 4BD1-T |
| | | | | | | 39148-4 | ISU | 4BB1 |
| | | | | | | 39149-4 | ISU | 4BD1 |
| | | | | | | 39151A-4 | ISU | 4BD1-II |
| | | | | | | 39227A | ISU | 4BD1 LATE |
| | | | | | | 39611AG | ISU | 4BD2-T |
| R39170 | 2.0 | 1.5 | | 3.0 | | 39170 | ISU | 4EC1 OLD |
| | | | | | | 39179 | ISU | 4EC1 TURBO |
| R39180 | 3.0 | 2.5 | | 5.0 | | 39180 | ISU | 4BE1 |
| | | | | | | 39612 | ISU | 4BE1-II |
| R39181 | 3.0 | 2.5 | | 4.0 | | 39181 | ISU | 4HF1 |
| | | | | | | 39187 | ISU | 4HF1-II |
| R39182 | 3.0 | 2.5 | | 4.0 | | 39182 | ISU | 6BG1 |
| R39189 | 2.0 | 1.5 | | 3.0 | | 39189 | ISU | 4EE1-T |
| | | | | | | 39668A | ISU | 4EE1 |
| R39232 | 2.5 | 2.0 | | 3.0 | | 39232AG | ISU | 4JH1-TC |
| R39600 | 2.5 | 2.0 | | 4.0 | | 39600 | ISU | 4JG2 EARLY |
| | | | | | | 39608AG | ISU | 4JG2-T |
| | | | | | | 39660AG | ISU | 4JG2-T NEW |
| R39601 | 2.5 | 2.0 | | 4.5 | | 39601 | ISU | C-223 OLD |
| R39602 | 2.0 | 2.0 | | 4.0 | | 39602 | ISU | 4FG1 |
| R39606 | 3.0 | 2.5 | | 4.0 | | 39606 | ISU | 6SA1 |
| | | | | | | 39615AG | ISU | 6SA1-T |
| R39607 | 3.0 | 2.5 | | 4.0 | | 39607 | ISU | 6HE1 |



PISTON RING LIST

| TEIKIN RING NUMBER | SIZE | | | | | TEIKIN PISTON NUMBER | ENGINE MODEL | |
|--------------------|-------------|-----|-----|-----|-----|-----------------------------|-------------------|------------------------------|
| | RING GROOVE | | | OIL | | | | |
| | 1 | 2 | 3 | 1 | 2 | | | |
| R39609 | 2.5 | 2.0 | | 4.0 | | 39609 | ISU | C-223-T |
| R39614 | 3.5 | 2.5 | | 4.0 | | 39614 | ISU | 6BG1-T |
| R39616 | 3.0 | 2.5 | | 5.0 | | 39616 | ISU | 6BF1 |
| R39617 | 3.0 | 3.0 | 3.0 | 6.0 | | 39617 | ISU | DH100 |
| R39620 | 2.0 | 2.0 | 2.0 | 5.0 | 5.0 | 39620 | ISU | C-221-II |
| R39623 | 3.5 | 2.5 | | 5.0 | | 39623 | ISU | 6SD1 |
| R39624 | 4.0 | 2.5 | | 5.0 | | 39624 | ISU | 6RB1 |
| R39625 | 3.0 | 2.5 | | 4.0 | | 39625 | ISU | 10PC1 |
| R39626 | 4.0 | 2.5 | | 4.0 | | 39626 | ISU | 10PD1 |
| R39651 | 3.5 | 2.5 | | 4.0 | | 39651A | ISU | 6HH1 |
| R39653 | 3.0 HK | 2.5 | | 4.0 | | 39653 39671AG 39676AG | ISU ISU ISU | 4HG1 4HK1-TC-II 4HG1-T |
| R39655 | 3.0 | 2.0 | | 4.0 | | 39655AG | ISU | 4BD2-T LATE |
| R39657 | 3.0 | 2.5 | | 6.0 | | 39657A | ISU | 6QA1 |
| R39661 | 2.5 FK | 2.0 | | 4.0 | | 39661AG | ISU | 4JX1 |
| R39662 | 3.0 | 2.5 | | 6.0 | | 39662A | ISU | PA1 |
| R39663 | 3.9 FK | 3.0 | 2.5 | 3.0 | | 39663AG | ISU | 6HE1-T |
| R39664 | 3.0 HK | 2.0 | 1.2 | 3.0 | | 39664AG | ISU | 4HE1-TC |
| R39665 | 2.95 HK | 2.0 | 2.5 | 3.0 | | 39665AG | ISU | 6HK1-TC |
| R39666 | 3.0 HK | 2.5 | | 4.0 | | 39666AG | ISU | 4HE1-T |
| R39669 | 2.5 FK | 2.0 | | 4.0 | | 39669AG | ISU | 4JG2-T-II |
| R39670 | 3.0 | 2.0 | | 3.0 | | 39670AG | ISU | 4HL1 |
| R39672 | 3.0 HK | 2.5 | | 4.0 | | 39672A | ISU | 4HF1 NEW |
| R39674 | 2.0 HK | 1.5 | | 3.0 | | 39674AG 39675AG | ISU ISU | 4JJ1-TC CRDI 4JK1-TC |
| R39677 | 3.0 FK | 2.5 | | 3.0 | | 39677AG | ISU | 6HL1-TC |



PISTON RING LIST

| TEIKIN RING NUMBER | SIZE | | | | | TEIKIN PISTON NUMBER | ENGINE MODEL | |
|--------------------|-------------|-----|-----|------|-----|----------------------|--------------|----------|
| | RING GROOVE | | | OIL | | | | |
| | 1 | 2 | 3 | 1 | 2 | | | |
| R42107 | 2.5 | 2.0 | | 4.5 | | 42107 | MAZ | SL |
| R42149 | 2.4 | 2.4 | | 4.8 | | 42149 | MAZ | HA |
| | | | | | | 42609 | MAZ | HA-II |
| R42150 | 2.4 | 2.4 | 2.4 | 4.8 | 4.8 | 42150 | MAZ | XB |
| R42150-6 | 2.4 | 2.4 | 2.4 | 4.8 | 4.8 | 42150-6 | MAZ | ZB OLD |
| R42167 | 2.0 | 2.0 | | 4.0 | | 42167 | MAZ | R2 |
| | | | | | | 42671A | MAZ | RF-II |
| R42174 | 2.4 | 2.4 | | 4.75 | | 42174 | MAZ | S2 |
| | | | | | | 42606 | MAZ | S5 |
| | | | | | | 42659 | MAZ | XA-II |
| R42179 | 2.4 | 2.4 | | 4.8 | | 42179 | MAZ | ZB |
| R42184 | 2.5 HK | 2.0 | | 4.5 | | 42183 | MAZ | TF |
| | | | | | | 42184AG | MAZ | TF-II |
| R42185 | 2.5 | 2.0 | | 3.0 | | 42185 | MAZ | WL-T |
| | | | | | | 42186 | MAZ | WL |
| R42198 | 2.85 FK | 2.4 | | 4.0 | | 42198 | MAZ | SS K2700 |
| R42212 | 2.0 | 1.5 | | 2.0 | | 42212AG | MAZ | MZ-DE |
| R42213 | 2.0 | 1.5 | | 2.0 | | 42213AG | MAZ | MZR-CD |
| R42215 | 2.5 | 2.0 | | 3.0 | | 42215AG | MAZ | W9 |
| R42601 | 2.0 | 1.5 | | 3.0 | | 42601 | MAZ | PN |
| R42605 | 2.4 | 2.4 | 2.4 | 4.8 | 4.8 | 42605 | MAZ | XA |
| R42610 | 2.0 HK | 2.0 | | 3.0 | | 42610AG | MAZ | RF |
| R42611 | 2.0 | 2.0 | | 3.0 | | 42611 | MAZ | R2 LATE |
| | | | | | | 42674AG | MAZ | R2 NEW |
| | | | | | | 42675AG | MAZ | RF7 |
| R42613 | 2.5 | 2.0 | | 4.5 | | 42613AG | MAZ | SL-T |
| R42657 | 2.0 | 2.0 | | 3.0 | | 42657 | MAZ | JS K2700 |
| R42658 | 2.4 | 2.4 | | 4.0 | | 42658 | MAZ | SF K2400 |
| R42663 | 3.0 HK | 2.0 | | 3.0 | | 42663AG | MAZ | TM |



PISTON RING LIST

| TEIKIN RING NUMBER | SIZE | | | | | TEIKIN PISTON NUMBER | ENGINE MODEL | |
|--------------------|-------------|----------|-----|-----|---|----------------------|--------------|-----------------|
| | RING GROOVE | | | OIL | | | | |
| | 1 | 2 | 3 | 1 | 2 | | | |
| R43102 | 3.0 HK | 2.5 | | 5.0 | | 43102 | MIT | 6D14 |
| | | | | | | 43289 | MIT | 6D14.A |
| | | | | | | 43615 | MIT | 6D14-T |
| | | | | | | 43668A | MIT | 6D14-T-II |
| R43104 | 3.0 HK | 2.5 | | 5.0 | | 43104 | MIT | 6D15 |
| | | | | | | 43283A | MIT | 6D15-II |
| | | | | | | 43686A | MIT | 6D15-III |
| R43105 | 3.0 | 2.5 | | 4.0 | | 43105 | MIT | 6D16 |
| | | | | | | 43267 | MIT | 6D17-1A |
| R43107 | 3.5 | 2.5 | 2.5 | 5.0 | | 43107 | MIT | 6DB NEW |
| R43115 | 3.0 HK | 2.0 | | 5.0 | | 43115 | MIT | 6DS7 |
| | | | | | | 43115N | MIT | 6DS7 NEW |
| R43157 | 2.5 HK | 2.0 | 2.0 | 4.5 | | 43157 | MIT | 4DR5 |
| | | | | | | 43609 | MIT | 4DR51/4DR5 LATE |
| R43166 | 3.0 HK | 2.0 | | 5.0 | | 43164 | MIT | 4D30 OLD |
| | | | | | | 43166 | MIT | 4D30 |
| | | | | | | 43168 | MIT | 4D31 / 4D31T |
| | | | | | | 43617 | MIT | 4D31 T |
| R43168-6 | 3.0 HK | 2.0 | | 5.0 | | 43168-6 | MIT | 6D31 / 6D31T |
| R43170 | 2.8 FK | 2.0 | | 4.0 | | 43170 | MIT | 4D34 |
| | | | | | | 43280 | MIT | 4D36 |
| | | | | | | 43605 | MIT | 4D34T |
| | | | | | | 43619 | MIT | 4D32 LATE |
| | | | | | | 43666 | MIT | 4D32 NEW |
| | | | | | | 43293AG | MIT | 4D34T NEW |
| 43693A | MIT | 4D34T-II | | | | | | |
| R43171 | 2.5 | 2.0 | | 4.0 | | 43171 | MIT | 4D55 / 4D56 |
| | | | | | | 43285 | MIT | 4D56-II |
| | | | | | | 43291 | MIT | 4D56 LATE |
| R43173 | 2.5 HK | 2.0 HK | | 4.0 | | 43173 | MIT | 4D56T |
| | | | | | | 43661 | MIT | 4D56-T LATE-II |
| | | | | | | 43242AG | MIT | 4D56-T LATE |
| | | | | | | 43672AG | MIT | 4D55T/4D56T-II |
| | | | | | | 43678AG | MIT | 4D56T CDRI |
| R43223 | 2.8 FK | 2.5 | | 4.0 | | 43223 | MIT | 6D16-T |
| R43227 | 3.0 HK | 2.0 | | 4.0 | | 43227 | MIT | 4D32 |
| R43229 | 2.0 HK | 2.0 HK | | 4.0 | | 43229 | MIT | 4D65T |



PISTON RING LIST

| TEIKIN RING NUMBER | SIZE | | | | | TEIKIN PISTON NUMBER | ENGINE MODEL | |
|--------------------|-------------|--------|-----|-----|---|---------------------------|--------------|------------------------------|
| | RING GROOVE | | | OIL | | | | |
| | 1 | 2 | 3 | 1 | 2 | | | |
| R43229 | 2.0 HK | 2.0 HK | | 4.0 | | 43241 43264 43286 | MIT | 4D65T OLD 4D65 4D65-II |
| R43232 | 2.3 FK | 2.0 | | 4.0 | | 43232 43610 43673A | MIT | 4M40-T 4DR7 4M40 |
| R43244 | 3.0 | 2.0 | | 4.0 | | 43244 | MIT | 4D33 |
| R43275 | 3.5 FK | 3.0 | 3.0 | 4.0 | | 43275A | MIT | 8DC91-T |
| R43605-6 | 2.8 FK | 2.0 | | 4.0 | | 43605-6 | MIT | 6D34T |
| R43608 | 3.0 | 2.5 | | 4.0 | | 43608 | MIT | 4D35 |
| R43612 | 2.0 HK | 2.0 HK | | 3.0 | | 43612 | MIT | 4D68T |
| R43613 | 2.0 HK | 2.0 | | 3.0 | | 43613 | MIT | 4D68 |
| R43614 | 3.5 FK | 3.0 | | 6.0 | | 43614 | MIT | 6D22 |
| R43618 | 4.0 HK | 3.0 | | 6.0 | | 43618 | MIT | 8DC8 |
| R43655 | 2.5 HK | 2.0 | | 4.5 | | 43655 43682 43682-6 | MIT | S4E S4S S6S |
| R43659 | 3.3 HK | 3.0 | 3.0 | 4.0 | | 43659A | MIT | 8DC11 |
| R43660 | 3.3 FK | 3.0 | 3.0 | 6.0 | | 43660A | MIT | 8DC9 |
| R43663 | 2.5 FK | 1.5 | | 3.0 | | 43663AG | MIT | 4M41-T |
| R43664 | 3.0 HK | 2.0 | | 4.0 | | 43664A | MIT | 4D31-T LATE |
| R43665 | 3.0 | 2.5 | | 4.0 | | 43665A | MIT | 6D14-T.2A |
| R43670 | 2.3 FK | 2.0 | | 3.0 | | 43670AG 43681AG | MIT | 4M40-T-II 4M42-0AT |
| R43674 | 3.0 | 2.0 | | 3.0 | | 43674A | MIT | 4M51 |
| R43675 | 2.8 FK | 2.5 | | 4.0 | | 43675A | MIT | 6D15.3AT |
| R43683 | 3.0 | 2.0 | | 4.0 | | 43683 | MIT | 4M51T |
| R43684 | 2.8 FK | 2.5 | | 4.0 | | 43684A | MIT | 6D14.3AT |
| R43685 | 3.0 FK | 2.0 | | 4.0 | | 43685AG | MIT | 4M50T |



PISTON RING LIST

| TEIKIN RING NUMBER | SIZE | | | | | TEIKIN PISTON NUMBER | ENGINE MODEL | |
|--------------------|-------------|-----|-----|-----|-----|----------------------|--------------|---------------------------|
| | RING GROOVE | | | OIL | | | | |
| | 1 | 2 | 3 | 1 | 2 | | | |
| R43687 | 2.5 | 2.0 | | 4.0 | | 43687 | MIT | 4DQ5 |
| R43688 | 3.0 HK | 2.0 | | 5.0 | | 43688 | MIT | S4E2 |
| R43691 | 3.0 | 2.0 | | 4.0 | | 43691AG | MIT | 4D35 / 4D35T |
| R43695 | 3.0 | 2.0 | | 4.0 | | 43695AG | MIT | 6M61 |
| R44176 | 2.0 | 2.0 | | 4.0 | | 44176 44263 | NIS NIS | LD20 LD20-II |
| R44210 | 2.5 | 2.0 | 2.0 | 4.5 | 4.5 | 44210 | NIS | SD22 |
| R44210-6 | 2.5 | 2.0 | 2.0 | 4.5 | 4.5 | 44210-6 | NIS | SD33 |
| R44215 | 2.5 | 2.0 | | 4.5 | | 44215 44622 | NIS NIS | SD23 / SD25 SD23/25-II |
| R44236 | 5.0 | 3.5 | | 5.0 | | 44236 | NIS | PD6 |
| R44242 | 4.0 | 3.0 | | 6.0 | | 44242 | NIS | RD8 |
| R44244 | 4.0 | 3.0 | | 5.0 | | 44244 | NIS | ND6 |
| R44246 | 3.0 HK | 2.5 | | 4.0 | | 44246 | NIS | NE6 |
| R44255 | 2.5 | 2.0 | | 4.0 | | 44255 44666A | NIS NIS | TD25 TD25 LATE |
| R44261 | 3.0 HK | 2.0 | | 4.0 | | 44261 | NIS | FE6T |
| R44262 | 1.75 | 2.0 | | 3.0 | | 44262 | NIS | CD17 |
| R44264 | 3.0 | 3.0 | | 5.0 | | 44264A 44264A-10 | NIS NIS | RE8 RE10 |
| R44266 | 2.5 | 2.0 | | 4.0 | | 44266 44291 | NIS NIS | TD23 SD22-II |
| R44267 | 2.5 | 2.0 | | 4.0 | | 44267 44619 | NIS NIS | TD27 BD30 |
| R44267-6 | 2.5 | 2.0 | | 4.0 | | 44267-6 | NIS | TD42 |
| R44276 | 1.5 HK | 1.5 | | 3.0 | | 46276 | TOY | 1N |
| R44290 | 2.5 | 2.5 | | 4.0 | | 44290 | NIS | RF8 |
| R44295 | 2.0 | 2.0 | | 3.0 | | 44295 | NIS | LD23 |



PISTON RING LIST

| TEIKIN RING NUMBER | SIZE | | | | | TEIKIN PISTON NUMBER | ENGINE MODEL | |
|--------------------|-------------|-----|-----|-----|---|-----------------------------|-------------------|------------------------------|
| | RING GROOVE | | | OIL | | | | |
| | 1 | 2 | 3 | 1 | 2 | | | |
| R44296 | 2.5 HK | 2.0 | | 3.0 | | 44296 44654AG 44672AG | NIS NIS NIS | TD27-T - II BD30T ZD30 |
| R44297 | 2.5 | 2.0 | | 3.0 | | 44297 | NIS | QD32 |
| R44323 | 3.0 HK | 2.0 | | 4.5 | | 44323A 44657A | NIS NIS | FD6T FD6T-II |
| R44330 | 4.0 HK | 3.5 | | 6.0 | | 44330A | NIS | PE6-T |
| R44602 | 2.0 | 2.0 | | 3.0 | | 44602 | NIS | CD20 |
| R44603 | 2.5 HK | 2.0 | | 4.0 | | 44603 | NIS | SD33T |
| R44605 | 3.0 | 2.0 | | 4.5 | | 44605 44698A | NIS NIS | ED33 FD33 |
| R44606 | 2.0 | 2.0 | | 4.0 | | 44606 44623AG | NIS NIS | RD28 RD28-T |
| R44618 | 3.0 | 2.0 | | 4.0 | | 44618 44665AG | NIS NIS | FD46 FD42 |
| R44620 | 2.0 | 2.0 | | 4.0 | | 44620 | NIS | FD35 |
| R44621 | 2.5 HK | 2.0 | | 4.0 | | 44621AG 44674AG | NIS NIS | TD27-T TD27-T NEW |
| R44621-6 | 2.5 HK | 2.0 | | 4.0 | | 44621AG-6 | NIS | TD42-T |
| R44624 | 2.0 | 2.0 | | 4.0 | | 44624 | NIS | LD20-T |
| R44625 | 2.0 | 2.0 | | 4.0 | | 44625 | NIS | LD28 |
| R44629 | 3.1 HK | 2.0 | | 4.5 | | 44629A | NIS | FD33-T |
| R44630 | 2.5 | 2.0 | | 3.0 | | 44630 | NIS | TD27-LATE |
| R44630-6 | 2.5 | 2.0 | | 3.0 | | 44630-6 | NIS | TD42-LATE |
| R44655 | 4.0 FK | 3.5 | | 6.0 | | 44655A | NIS | PE6 |
| R44656 | 2.6 HK | 2.0 | | 4.0 | | 44344A 44656A 44692A | NIS NIS NIS | FE6T-II FE6TA FE6T NEW |
| R44658 | 3.0 HK | 2.0 | 2.0 | 4.5 | | 44658A | NIS | FD6T-III |
| R44659 | 3.0 HK | 2.0 | | 4.0 | | 44659 | NIS | FD35-T |



PISTON RING LIST

| TEIKIN RING NUMBER | SIZE | | | | | TEIKIN PISTON NUMBER | ENGINE MODEL | |
|--------------------|-------------|-----|-----|-----|---|-------------------------|-------------------|----------------------------------|
| | RING GROOVE | | | OIL | | | | |
| | 1 | 2 | 3 | 1 | 2 | | | |
| R44667 | 3.0 | 2.0 | | 4.0 | | 44667A | NIS | FE6 |
| R44670 | 3.0 | 2.0 | 2.0 | 4.5 | | 44670 | NIS | ED30 |
| R44671 | 2.0 HK | 2.0 | | 3.0 | | 44671AG 44686AG | NIS NIS | YD25TDI YD25DDTI |
| R44673 | 2.5 HK | 2.0 | | 2.0 | | 44673AG 44678AG | NIS NIS | ZD30 LATE ZD30DDTI |
| R44679 | 4.0 FK | 3.5 | | 5.0 | | 44679A | NIS | PD6-T |
| R44681 | 2.0 HK | 2.0 | | 3.0 | | 44681AG | NIS | CD20-T |
| R44683 | 2.6 HK | 2.0 | | 3.0 | | 44683AG | NIS | QD32TI |
| R44684 | 2.0 HK | 2.0 | | 3.0 | | 44684AG | NIS | YD25TDI NEW |
| R44685 | 2.0 HK | 2.0 | | 3.0 | | 44685AG 44697AG | NIS NIS | YD22DDT/ETI YD22DDT/DDTI |
| R44694 | 3.0 | 2.0 | | 4.0 | | 44694A | NIS | ED35 |
| R44702 | 2.0 | 1.2 | | 2.0 | | 44702AG | NIS | ZD30DD |
| R46112 | 2.0 HK | 2.0 | | 4.0 | | 46112 | TOY | 1C |
| R46124 | 2.5 HK | 2.5 | | 4.5 | | 46124 46287 | TOY TOY | B, BU-30 11B |
| R46127 | 2.5 HK | 2.5 | | 4.5 | | 46127 | TOY | 2B |
| R46128 | 2.5 HK | 2.5 | | 4.5 | | 46128 | TOY | 3B |
| R46130 | 2.5 | 2.5 | | 4.5 | | 46130 | TOY | 13B |
| R46226 | 2.5 HK | 2.5 | | 4.0 | | 46226 46226-6 | TOY TOY | 2J H NEW |
| R46231 | 2.5 HK | 2.5 | | 4.0 | | 46231 46611 | TOY TOY | 2H 2H LATE |
| R46234 | 2.5 | 2.0 | | 4.0 | | 46234 | TOY | L OLD, LN30 |
| R46236 | 2.0 HK | 2.0 | | 4.0 | | 46236 46238 | TOY TOY | L NEW, LN50 L NEW-II |
| R46240 | 2.0 HK | 2.0 | | 4.0 | | 46240 46261 46600 | TOY TOY TOY | 2L 2L-II, 2L LATE 2LT LATE |



PISTON RING LIST

| TEIKIN RING NUMBER | SIZE | | | | | TEIKIN PISTON NUMBER | ENGINE MODEL | |
|--------------------|-------------|-----|-----|-----|-----|----------------------|--------------|---------------------|
| | RING GROOVE | | | OIL | | | | |
| | 1 | 2 | 3 | 1 | 2 | | | |
| R46240 | 2.0 HK | 2.0 | | 4.0 | | 46602 | TOY | 2L-T, 2L-THE, 2L-TE |
| | | | | | | 46351A | TOY | 2LT NEW-II |
| R46242 | 3.0 | 3.0 | 3.0 | 5.0 | 5.0 | 46242 | TOY | 2D OLD |
| R46244 | 3.0 HK | 2.5 | 2.5 | 5.0 | | 46244 | TOY | 2D NEW |
| R46254 | 2.5 HK | 2.0 | | 4.0 | | 46254 | TOY | 14B |
| | | | | | | 46622 | TOY | 3B-II |
| R46256 | 2.0 HK | 2.0 | | 4.0 | | 46256 | TOY | 3L |
| R46257 | 2.0 HK | 2.0 | | 4.0 | | 46257 | TOY | 1HZ, 1PZ |
| | | | | | | 46268 | TOY | 1HD-T LATE |
| | | | | | | 46325 | TOY | 1HD-T-II |
| | | | | | | 46362AG | TOY | 1HD-FT |
| R46260 | 1.75 HK | 2.0 | | 3.0 | | 46260 | TOY | 2C |
| | | | | | | 46264 | TOY | 2C-II, 2CT LATE |
| R46273 | 2.0 HK | 1.5 | | 4.0 | | 46273 | TOY | 5L |
| R46278 | 2.0 HK | 2.0 | | 3.0 | | 46278 | TOY | 2C-T |
| | | | | | | 46374 | TOY | 2C-IV |
| | | | | | | 46684 | TOY | 1DZ NEW |
| | | | | | | 46629A | TOY | 3C |
| | | | | | | 46695AG | TOY | 2CT-III |
| R46283 | 2.0 HK | 2.0 | | 3.0 | | 46283 | TOY | 1KZ-TE, 1KZ |
| | | | | | | 46671AG | TOY | 1KZ-TE NEW |
| R46308 | 2.5 HK | 2.5 | 2.5 | 4.5 | | 46308 | TOY | BU-30-II |
| R46316 | 2.5 HK | 2.5 | | 4.0 | | 46316 | TOY | H-II |
| R46348 | 2.0 | 1.5 | | 3.0 | | 46348AG | TOY | 2KD - FTV |
| R46369 | 2.5 HK | 2.5 | 2.5 | 4.0 | | 46369 | TOY | 2J-III |
| R46381 | 2.5 | 2.0 | | 4.0 | | 46381A | TOY | S05C-II |
| R46601 | 2.0 HK | 2.0 | | 4.0 | | 46601 | TOY | 2C-III |
| | | | | | | 46609 | TOY | 2CT-II |
| R46608 | 2.5 HK | 2.0 | | 4.0 | | 46608 | TOY | 11B-II |
| | | | | | | 46626 | TOY | B LATE |
| R46613 | 2.0 | 2.0 | | 4.0 | | 46613 | TOY | 1Z |
| R46624 | 2.5 HK | 2.5 | | 4.0 | | 46624 | TOY | 12H-T |



PISTON RING LIST

| TEIKIN RING NUMBER | SIZE | | | | | TEIKIN PISTON NUMBER | ENGINE MODEL | |
|--------------------|-------------|-----|---|-----|---|-------------------------------|-------------------|--|
| | RING GROOVE | | | OIL | | | | |
| | 1 | 2 | 3 | 1 | 2 | | | |
| R46625 | 3.0 HK | 2.0 | | 4.0 | | 46625 | TOY | 14B-T |
| R46630 | 2.0 HK | 2.0 | | 3.0 | | 46630 46650 46692 | TOY TOY TOY | 1C-III 1C-II 1C NEW |
| R46654 | 2.0 HK | 2.0 | | 4.0 | | 46654A | TOY | 1DZ |
| R46655 | 3.0 HK | 2.0 | | 4.0 | | 46655A 46656AG | TOY TOY | 15BF 15BF-T |
| R46668 | 2.5 HK | 2.5 | | 4.5 | | 46668A | TOY | 13B-T |
| R46674 | 2.0 | 1.5 | | 4.0 | | 46674AG | TOY | 1HD-FTE |
| R46675 | 2.0 HK | 1.5 | | 3.0 | | 46675AG 46686AG 46698AG | TOY TOY TOY | 1KD-FTV 1KD-FTV-II 1KD-FTV-III |
| R46676 | 1.5 | 1.5 | | 3.0 | | 46676AG | TOY | 1ND-TV |
| R46678 | 2.0 | 1.5 | | 2.0 | | 46678AG 46679AG 46696AG | TOY TOY TOY | 1AD-FTV 2AD-FHV 2AD-FTV |
| R46680 | 2.0 | 1.5 | | 3.0 | | 46680AG 46690AG | TOY TOY | 1CD-FTV 1CD-FTV-II |
| R46682 | 2.0 | 2.0 | | 4.0 | | 46682 | TOY | 2Z NEW |
| R46685 | 2.0 | 2.0 | | 4.0 | | 46685 | TOY | 13Z |
| R46691 | 2.0 | 1.5 | | 2.0 | | 46691AG | TOY | 1VD-FTV |
| R48101 | 1.75 | 2.0 | | 3.0 | | 48101A | VW | ME, JP, JK, DW, CS |
| R48112 | 1.75 | 2.0 | | 3.5 | | 48112 | VW | DJ |
| R48601 | 1.75 | 2.0 | | 3.0 | | 48601A | VW | 1G / 1V / CY TURBO |
| R48602 | 1.75 | 2.0 | | 3.0 | | 48602A 48603A | VW VW | 1X / 1Y / AAB AAZ / ABL / ADE TURBO |
| R51102 | 2.0 | 2.0 | | 3.0 | | 51102 51108 | HYU HYU | D4BB D4BA |
| R51103 | 3.0 HK | 2.0 | | 4.0 | | 51103 | HYU | D4AF |
| R51103 | 3.0 HK | 2.0 | | 4.0 | | 51607A | HYU | D4AF-III |



PISTON RING LIST

| TEIKIN RING NUMBER | SIZE | | | | | TEIKIN PISTON NUMBER | ENGINE MODEL | |
|--------------------|-------------|--------|---|-----|---|----------------------|--------------|-----------------|
| | RING GROOVE | | | OIL | | | | |
| | 1 | 2 | 3 | 1 | 2 | | | |
| R51112 | 3.0 FK | 2.0 | | 4.0 | | 51112 | HYU | D4AE |
| R51142 | 1.75 | 1.75 | | 3.0 | | 51142AG | HYU | i20 MAGNA CDRI |
| R51602 | 3.0 FK | 2.0 | | 4.0 | | 51602AG | HYU | D4DA |
| R51603 | 2.5 HK | 2.0 | | 3.0 | | 51603AG | HYU | D4CB CRDI |
| R51604 | 2.0 FK | 2.0 | | 3.0 | | 51604A | HYU | D3EA |
| | | | | | | 51604A-4 | HYU | D4EA |
| R51605 | 2.5 FK | 2.0 | | 3.0 | | 51605AG | HYU | D4EB-F/D4EB-G |
| R51606 | 2.5 HK | 2.0 HK | | 4.0 | | 51606AG | HYU | D4BH |
| R52107 | 2.0 HK | 2.0 | | 3.0 | | 52107AG | KIA | CARNIVAL-II |
| R52650 | 2.0 | 2.0 | | 3.0 | | 52650A | KIA | RFA |
| R52651 | 2.0 | 2.0 | | 3.0 | | 52651A | KIA | JT 3.0 |
| R52652 | 2.5 | 2.0 | | 4.5 | | 52652A | KIA | JD K3500 |
| R52653 | 2.0 | 2.0 | | 3.0 | | 52653G | KIA | SH K3600 |
| | | | | | | 52656G | KIA | SH K3600 NEW-II |
| R56605 | 2.0 | 1.5 | | 2.0 | | 56605A | OPE | Y 13 DT/Z 13 DT |
| R56606 | 2.0 | 1.5 | | 3.0 | | 56606A | OPE | Y 17 DT/DTL |
| R62101 | 2.0 | 2.0 | | 3.0 | | 62101A | TAT | INDICA |
| | | | | | | 62101A-2 | TAT | ACE |
| R64601 | 2.0 | 2.0 | | 4.0 | | 64601 | KOM | 4D95 |
| R64602 | 3.0 | 2.5 | | 5.0 | | 64602A | KOM | 4D105 |



CYLINDER LINER LIST

CYLINDER LINER LIST

| TEIKIN LINER NUMBER | TEIKIN PISTON NUMBER | ENGINE MODEL | TEIKIN LINER NUMBER | TEIKIN PISTON NUMBER | ENGINE MODEL |
|---------------------|----------------------|-----------------------------------|---------------------|----------------------|----------------------------|
| LSF 29602 | 29602A | MER OM 661 ALFIN | LFF 36552 | 36652A | HIN H06BT ALFIN |
| LSF 29603 | 29603A | MER OM 601 ALFIN | LFF 36653 | 36653 | HIN W04D |
| LSF 29604 | 29604AG | MER OM 602 TURBO ALFIN GALLERY | LSF 36653 | 36658 | HIN W04D LATE |
| LFF 32102 | 32102 | DAI DG | | 36660A | HIN W04CT ALFIN |
| LSF 32102 | 32103 | DAI DG OLD-4R | LFF 36654 | 36654A | HIN EF750 ALFIN |
| LSF 32120 | 32120 | DAI CL | LFF 36657 | 36657-6 | HIN J08C |
| LSX 32120 | 32602 | DAI CL-T | | 36657A | HIN J05C ALFIN |
| LFF 32126 | 32126 | DAI DL | | 36659AG | HIN J08C-T ALFIN GALLERY |
| LSF 32126 | 32127 | DAI DL NEW-28 | | 36659AG-4 | HIN J05C-T ALFIN GALLERY |
| | 32128 | DAI DL NEW-26 | | 36659AG-5 | HIN J07C-T ALFIN GALLERY |
| LFF 32139 | 32139 | DAI DG OLD-5R | LSF 38658 | 38658A | HON 20T2N/20T2 TURBO ALFIN |
| LSF 32139 | | | LSX 38658 | | |
| LSF 34129 | 34129A | FIA PALIO 1.3L JTD ALFIN | LCF 39125 | 39125 | ISU C-240 OLD |
| LSX 35601 | 35601A | FOR 4A B/ BA / BB / CA / FA ALFIN | LSF 39125 | 39127 | ISU C-190 |
| LFF 36101 | 36101 | HIN DM-100 | | 39621 | ISU C-240 |
| LFF 36111 | 36111 | HIN EH-100 | LCF 39128 | 39128 | ISU C-190-3R |
| LFF 36113 | 36113 | HIN EH-700 | LSF 39128 | | |
| LSF 36113 | 36124 | HIN H07C NEW | LCF 39130 | 39130 | ISU C-223 |
| | 36125 | HIN H07C OLD | LSF 39130 | 39601 | ISU C-223 OLD |
| | 36127 | HIN H07D | | 39609 | ISU C-223-T |
| | 36129AG | HIN H07C-T ALFIN GALLERY | LFF 39137 | 39137 | ISU DA-120-4R |
| | 36655AG | HIN H07C-T-II ALFIN GALLERY | | 39137-4 | ISU DA220 |
| LFF 36128 | 36128 | HIN EM 100 | LFF 39142 | 39142 | ISU DA-640 |
| LFF 36135 | 36135A | HIN H06CTE ALFIN | LCF 39148 | 39148 | ISU 6BB1 |
| | 36136A | HIN H06CTB ALFIN | LSF 39148 | 39149 | ISU 6BD1 |
| LFF 36601 | 36601 | HIN EB300 | | 39151 | ISU 6BD1-II |
| LFF 36603 | 36603 | HIN EC100 | | 39184-6 | ISU 6BD1-III |
| LFF 36650 | 36650A | HIN EK100 ALFIN | | 39667A | ISU 6BD1-T ALFIN |
| LFF 36651 | 36651A | HIN W06D ALFIN | LSF 39157 | 39157 | ISU 4FC1 |
| | 36656A | HIN W06E ALFIN | LSX 39157 | 39183 | ISU 4FB1 |
| | 36661A | HIN W06DT ALFIN | LSF 39159 | 39159 | ISU 4FD1 |
| | | | LSX 39159 | | |
| | | | LCF 39160 | 39160 | ISU 4BA1 |
| | | | LSF 39160 | | |

CYLINDER LINER LIST

| TEIKIN LINER NUMBER | TEIKIN PISTON NUMBER | ENGINE MODEL | TEIKIN LINER NUMBER | TEIKIN PISTON NUMBER | ENGINE MODEL |
|---------------------|----------------------|-------------------------------|---------------------|----------------------|--------------------------------|
| LCF 39162 | 39162 | ISU 4JA1 | LFF 39606 | 39606 | ISU 6SA1 |
| LSF 39162 | 39231 | ISU 4JA1T NEW | | 39615AG | ISU 6SA1-T ALFIN GALLERY |
| | 39658A | ISU 4JA1 LATE ALFIN | | | |
| LCF 39163 | 39163 | ISU 4JB1 | LFF 39607 | 39607 | ISU 6HE1 |
| LFF 39163 | 39188 | ISU 4JB1-T | LSF 39607 | | |
| LSF 39163 | 39190 | ISU 4JB1-T LATE | | | |
| | 39656A | ISU 4JB1 LATE ALFIN | LFF 39617 | 39617 | ISU DH100 |
| LCF 39165 | 39165 | ISU 4BC1 | LCF 39620 | 39620 | ISU C-221-II |
| LFF 39165 | 39166 | ISU 4BC2 | LFF 39623 | 39623 | ISU 6SD1 |
| LSF 39165 | | | LFF 39624 | 39624 | ISU 6RB1 |
| LSF 39170 | 39170 | ISU 4EC1 OLD | LFF 39625 | 39625 | ISU 10PC1 |
| LSX 39170 | 39179 | ISU 4EC1 TURBO | LFF 39626 | 39626 | ISU 10PD1 |
| LCF 39180 | 39180 | ISU 4BE1 | LFF 39651 | 39651A | ISU 6HH1 ALFIN |
| | 39612 | ISU 4BE1-II | LSF 39651 | 39665AG | ISU 6HK1-TC ALFIN GALLERY |
| LFF 39181 | 39181 | ISU 4HF1 | | 39677AG | ISU 6HL1-TC ALFIN GALLERY |
| LSF 39181 | 39187 | ISU 4HF1-II | LFF 39653 | 39653 | ISU 4HG1 |
| | 39672A | ISU 4HF1 NEW ALFIN | LSF 39653 | 39676AG | ISU 4HG1-T ALFIN GALLERY |
| LCF 39182 | 39182 | ISU 6BG1 | LFF 39657 | 39657A | ISU 6QA1 ALFIN |
| LFF 39182 | 39614 | ISU 6BG1-T | LSF 39661 | 39661AG | ISU 4JX1 ALFIN GALLERY |
| | 39616 | ISU 6BF1 | LSX 39661 | 39674AG | ISU 4JJ1-TC CRDI ALFIN GALLERY |
| LSF 39189 | 39189 | ISU 4EE1-T | | 39675AG | ISU 4JK1-TC ALFIN GALLERY |
| LSX 39189 | 39668A | ISU 4EE1 ALFIN | LFF 39662 | 39662A | ISU PA1 ALFIN |
| LCF 39227 | 39618 | ISU 4BD1-T | LFF 39663 | 39663AG | ISU 6HE1-T ALFIN GALLERY |
| LFF 39227 | 39148-4 | ISU 4BB1 | LSF 39663 | | |
| LSF 39227 | 39149-4 | ISU 4BD1 | LFF 39664 | 39664AG | ISU 4HE1-TC ALFIN GALLERY |
| | 39151A-4 | ISU 4BD1-II ALFIN | LSF 39664 | | |
| | 39227A | ISU 4BD1 LATE ALFIN | LFF 39666 | 39666AG | ISU 4HE1-T ALFIN GALLERY |
| | 39611AG | ISU 4BD2-T ALFIN GALLERY | LSF 39666 | | |
| | 39655AG | ISU 4BD2-T LATE ALFIN GALLERY | LFF 39670 | 39670AG | ISU 4HL1 ALFIN GALLERY |
| LCF 39232 | 39600 | ISU 4JG2 EARLY | LSF 39670 | | |
| LSF 39232 | 39232AG | ISU 4JH1-TC ALFIN GALLERY | LFF 39671 | 39671AG | ISU 4HK1-TC-II ALFIN GALLERY |
| | 39608AG | ISU 4JG2-T ALFIN GALLERY | LSF 39671 | | |
| | 39660AG | ISU 4JG2-T NEW ALFIN GALLERY | | | |
| | 39669AG | ISU 4JG2-T-II ALFIN GALLERY | | | |
| LFX 39602 | 39602 | ISU 4FG1 | | | |
| LSF 39602 | | | | | |
| LSX 39602 | | | | | |

CYLINDER LINER LIST

| TEIKIN LINER NUMBER | TEIKIN PISTON NUMBER | ENGINE MODEL | TEIKIN LINER NUMBER | TEIKIN PISTON NUMBER | ENGINE MODEL |
|---------------------|----------------------|--------------------------|---------------------|----------------------|----------------------------------|
| LFF 42107 | 42107 | MAZ SL | LFF 42658 | 42658 | MAZ SF K2400 |
| LSF 42107 | 42613AG | MAZ SL-T ALFIN GALLERY | LSF 42658 | | |
| LFF 42149 | 42149 | MAZ HA | LFF 42663 | 42663AG | MAZ TM ALFIN GALLERY |
| | 42609 | MAZ HA-II | LSF 42663 | | |
| | 42215AG | MAZ W9 ALFIN GALLERY | | | |
| LFF 42150 | 42150 | MAZ XB | LFF 43102 | 43102 | MIT 6D14 |
| LSF 42150 | | | LSF 43102 | 43289 | MIT 6D14.A |
| | | | | 43615 | MIT 6D14-T |
| | | | | 43665A | MIT 6D14-T.2A ALFIN |
| LFF 42167 | 42167 | MAZ R2 | | 43668A | MIT 6D14-T-II ALFIN |
| LSF 42167 | 42671A | MAZ RF-II ALFIN | LFF 43104 | 43104 | MIT 6D15 |
| LSX 42167 | | | | 43686A | MIT 6D15-III ALFIN |
| LFF 42174 | 42174 | MAZ S2 | LFF 43105 | 43105 | MIT 6D16 |
| LSF 42174 | | | LSF 43105 | | |
| LFF 42179 | 42179 | MAZ ZB | LFF 43107 | 43107 | MIT 6DB NEW |
| LSF 42179 | 42150-6 | MAZ ZB OLD | LFF 43115 | 43115 | MIT 6DS7 |
| LFF 42183 | 42183 | MAZ TF | LFF 43115N | 43115N | MIT 6DS7 NEW |
| LSF 42183 | 42184AG | MAZ TF-II ALFIN GALLERY | LSX 43157 | 43157 | MIT 4DR5 |
| LFF 42185 | 42185 | MAZ WL-T | | 43609 | MIT 4DR51/4DR5 LATE |
| LSF 42185 | 42186 | MAZ WL | LSF 43166 | 43164 | MIT 4D30 OLD |
| | 42212AG | MAZ MZ-DE ALFIN GALLERY | LSX 43166 | 43166 | MIT 4D30 |
| LFF 42198 | 42198 | MAZ SS K2700 | LFX 43168 | 43168 | MIT 4D31/4D31T |
| LSF 42198 | | | LSF 43168 | 43617 | MIT 4D31 T |
| LFF 42213 | 42213AG | MAZ MZR-CD ALFIN GALLERY | LSX 43168 | 43664A | MIT 4D31-T LATE ALFIN |
| LSF 42213 | | | LSF 43168-6 | 43168-6 | MIT 6D31 / 6D31T |
| LSF 42601 | 42601 | MAZ PN | LSX 43168-6 | | |
| LSX 42601 | | | LFX 43170 | 43170 | MIT 4D34 |
| LFF 42605 | 42605 | MAZ XA | LSF 43170 | 43605 | MIT 4D34T |
| LSF 42605 | 42606 | MAZ S5 | LSX 43170 | 43293AG | MIT 4D34T NEW ALFIN GALLERY |
| | 42659 | MAZ XA-II | | 43693A | MIT 4D34T-II ALFIN |
| LFF 42610 | 42611 | MAZ R2 LATE | LFX 43171 | 43171 | MIT 4D55/4D56 |
| LSF 42610 | 42610AG | MAZ RF ALFIN GALLERY | LSF 43171 | 43173 | MIT 4D56T |
| LSX 42610 | 42674AG | MAZ R2 NEW ALFIN GALLERY | LSX 43171 | 43291 | MIT 4D56 LATE |
| | 42675AG | MAZ RF7 ALFIN GALLERY | | 43661 | MIT 4D56-T LATE-II |
| LFF 42657 | 42657 | MAZ JS K2700 | | 43242AG | MIT 4D56-T LATE ALFIN GALLERY |
| LSF 42657 | | | | 43672AG | MIT 4D55T/4D56T-II ALFIN GALLERY |
| | | | | 43678AG | MIT 4D56T CDRI ALFIN GALLERY |



CYLINDER LINER LIST

| TEIKIN LINER NUMBER | TEIKIN PISTON NUMBER | ENGINE MODEL | TEIKIN LINER NUMBER | TEIKIN PISTON NUMBER | ENGINE MODEL |
|---------------------|----------------------|--------------------------------|---------------------|----------------------|--------------------------|
| LFF 43223 | 43223 | MIT 6D16-T | LSF 43663 | 43663AG | MIT 4M41-T ALFIN GALLERY |
| LSF 43223 | | | LSX 43663 | | |
| LFX 43227 | 43227 | MIT 4D32 | LSF 43674 | 43683 | MIT 4M51T |
| LSF 43227 | 43280 | MIT 4D36 | LSX 43674 | 43674A | MIT 4M51 ALFIN |
| LSX 43227 | 43619 | MIT 4D32 LATE | LFF 43675 | 43675A | MIT 6D15.3AT ALFIN |
| | 43666 | MIT 4D32 NEW | LSF 43682 | 43682 | MIT S4S |
| LSF 43229 | 43229 | MIT 4D65T | LSX 43682 | 43682-6 | MIT S6S |
| LSX 43229 | 43241 | MIT 4D65T OLD | LFF 43684 | 43684A | MIT 6D14.3AT ALFIN |
| | 43264 | MIT 4D65 | LSF 43685 | 43685AG | MIT 4M50T ALFIN GALLERY |
| | 43286 | MIT 4D65-II | LSX 43685 | | |
| LFX 43232 | 43232 | MIT 4M40-T | LSX 43687 | 43687 | MIT 4DQ5 |
| LSF 43232 | 43670AG | MIT 4M40-T-II ALFIN GALLERY | LSF 43688 | 43688 | MIT S4E2 |
| LSX 43232 | 43673A | MIT 4M40 ALFIN | LSX 43688 | | |
| | 43681AG | MIT 4M42-0AT ALFIN GALLERY | LFX 44176 | 44176 | NIS LD20 |
| LFX 43244 | 43244 | MIT 4D33 | LSF 44176 | 44263 | NIS LD20-II |
| LSF 43244 | | | LSX 44176 | 44624 | NIS LD20-T |
| LSX 43244 | | | LFF 44210 | 44210 | NIS SD22 |
| LFF 43267 | 43267 | MIT 6D17-1A | LSF 44210 | 44291 | NIS SD22-II |
| | 43695AG | MIT 6M61 ALFIN GALLERY | LFF 44215 | 44215 | NIS SD23 / SD25 |
| LFF 43275 | 43275A | MIT 8DC91-T ALFIN | LSF 44215 | 44622 | NIS SD23/25-II |
| | 43660A | MIT 8DC9 ALFIN | LFF 44236 | 44236 | NIS PD6 |
| LFF 43283 | 43283A | MIT 6D15-II ALFIN | | 44679A | NIS PD6-T ALFIN |
| | 43605-6 | MIT 6D34T | LFF 44242 | 44242 | NIS RD8 |
| LFX 43608 | 43608 | MIT 4D35 | LFF 44244 | 44244 | NIS ND6 |
| LSF 43608 | 43691AG | MIT 4D35 / 4D35T ALFIN GALLERY | LSF 44244 | 44246 | NIS NE6 |
| LSX 43608 | | | LFF 44255 | 44255 | NIS TD25 |
| LSX 43610 | 43610 | MIT 4DR7 | LSF 44255 | 44666A | NIS TD25 LATE ALFIN |
| LFX 43612 | 43612 | MIT 4D68T | LFF 44261 | 44261 | NIS FE6T |
| LSF 43612 | 43613 | MIT 4D68 | LSF 44261 | 44344A | NIS FE6T-II ALFIN |
| LSX 43612 | | | | 44656A | NIS FE6TA ALFIN |
| LFF 43614 | 43614 | MIT 6D22 | | 44667A | NIS FE6 ALFIN |
| LFF 43618 | 43618 | MIT 8DC8 | | 44692A | NIS FE6T NEW ALFIN |
| LSX 43655 | 43655 | MIT S4E | | | |
| LFF 43659 | 43659A | MIT 8DC11 ALFIN | | | |

CYLINDER LINER LIST

| TEIKIN LINER NUMBER | TEIKIN PISTON NUMBER | ENGINE MODEL | TEIKIN LINER NUMBER | TEIKIN PISTON NUMBER | ENGINE MODEL |
|---------------------|----------------------|------------------------------|---------------------|-------------------------------|--------------------------------|
| LFX 44262 | 44262 | NIS CD17 | LFX 44606 | 44606 | NIS RD28 |
| LSF 44262 | | | 44623AG | NIS RD28-T ALFIN GALLERY | |
| LSX 44262 | | | | | |
| LFF 44264 | 44264A | NIS RE8 ALFIN | LFF 44618 | 44618 | NIS FD46 |
| | | | LSF 44618 | | |
| LFF 44264-10 | 44264A-10 | NIS RE10 ALFIN | LFF 44619 | 44619 | NIS BD30 |
| LSF 44264-10 | | | 44654AG | NIS BD30T ALFIN GALLERY | |
| LFF 44266 | 44266 | NIS TD23 | LFF 44620 | 44620 | NIS FD35 |
| LSF 44266 | | | 44659 | NIS FD35-T | |
| | | | | 44694A | NIS ED35 ALFIN |
| LFF 44267 | 44267 | NIS TD27 | LSF 44625 | 44625 | NIS LD28 |
| LSF 44267 | 44296 | NIS TD27-T - II | LSX 44625 | | |
| | 44630 | NIS TD27-LATE | | | |
| LFF 44267 | 44621AG | NIS TD27-T ALFIN GALLERY | LFF 44629 | 44629A | NIS FD33-T ALFIN |
| LSF 44267 | 44674AG | NIS TD27-T NEW ALFIN GALLERY | | 44698A | NIS FD33 ALFIN |
| LFF 44267-6 | 44267-6 | NIS TD42 | LFF 44665 | 44665AG | NIS FD42 ALFIN GALLERY |
| LSF 44267-6 | 44621AG-6 | NIS TD42-T ALFIN GALLERY | LSF 44665 | | |
| | 44630-6 | NIS TD42-LATE | | | |
| LFF 44290 | 44290 | NIS RF8 | LFF 44670 | 44670 | NIS ED30 |
| LSF 44290 | | | | | |
| LSF 44295 | 44295 | NIS LD23 | LSF 44671 | 44671AG | NIS YD25TDI ALFIN GALLERY |
| LSX 44295 | | | 44684AG | NIS YD25TDI NEW ALFIN GALLERY | |
| | | | | 44686AG | NIS YD25DDTI ALFIN GALLERY |
| LFX 44297 | 44297 | NIS QD32 | LSF 44672 | 44672AG | NIS ZD30 ALFIN GALLERY |
| LSF 44297 | 44683AG | NIS QD32TI ALFIN GALLERY | LSX 44672 | 44673AG | NIS ZD30 LATE ALFIN GALLERY |
| LSX 44297 | | | | 44678AG | NIS ZD30DDTI ALFIN GALLERY |
| | | | | 44702AG | NIS ZD30DD ALFIN GALLERY |
| LFF 44323 | 44323A | NIS FD6T ALFIN | LSF 44685 | 44685AG | NIS YD22DDT/ETI ALFIN GALLERY |
| | 44657A | NIS FD6T-II ALFIN | LSX 44685 | 44697AG | NIS YD22DDT/DDTI ALFIN GALLERY |
| | 44658A | NIS FD6T-III ALFIN | | | |
| LFF 44330 | 44330A | NIS PE6-T ALFIN | LFX 46112 | 46112 | TOY 1C |
| | 44655A | NIS PE6 ALFIN | LSF 46112 | 46630 | TOY 1C-III |
| LFX 44602 | 44602 | NIS CD20 | LSX 46112 | 46650 | TOY 1C-II |
| LSF 44602 | 44681AG | NIS CD20-T ALFIN GALLERY | | 46692 | TOY 1C NEW |
| LSX 44602 | | | | | |
| LFF 44603 | 44603 | NIS SD33T | LFF 46124 | 46124 | TOY B NEW |
| LSF 44603 | 44210-6 | NIS SD33 | LFF 46124 | 46626 | TOY B LATE |
| LFF 44605 | 44605 | NIS ED33 | LFF 46127 | 46127 | TOY 2B |
| LSF 44605 | | | | | |

CYLINDER LINER LIST

| TEIKIN LINER NUMBER | TEIKIN PISTON NUMBER | ENGINE MODEL | TEIKIN LINER NUMBER | TEIKIN PISTON NUMBER | ENGINE MODEL |
|---------------------|----------------------|---------------------------|---------------------|----------------------|-------------------------------|
| LFF 46128 | 46128 | TOY 3B | LSF 46276 | 46276 | TOY 1N |
| LSF 46128 | 46130 | TOY 13B | LSX 46276 | | |
| LSX 46128 | 46254 | TOY 14B | | | |
| | 46622 | TOY 3B-II | LFF 46283 | 46283 | TOY 1KZ-TE |
| | 46625 | TOY 14B-T | LSF 46283 | 46671AG | TOY 1KZ-TE NEW ALFIN GALLERY |
| | 46668A | TOY 13B-T ALFIN | | | |
| LFF 46226 | 46226 | TOY 2J | LFF 46287 | 46287 | TOY 11B |
| LSF 46226 | 46226-6 | TOY H NEW | LSF 46287 | 46608 | TOY 11B-II |
| | | | LSX 46287 | | |
| LFF 46231 | 46231 | TOY 2H | LFF 46308 | 46123 | TOY B OLD |
| LSF 46231 | 46611 | TOY 2H LATE | LSF 46308 | 46308 | TOY B NEW-II |
| | 46624 | TOY 12H-T | | | |
| LFF 46234 | 46234 | TOY L OLD | LFF 46316 | 46316 | TOY H-II |
| LSF 46234 | 46236 | TOY L NEW | LSF 46316 | | |
| | 46238 | TOY L NEW-II | | | |
| LFF 46240 | 46240 | TOY 2L | LSF 46348 | 46348AG | TOY 2KD - FTV ALFIN GALLERY |
| LSF 46240 | 46261 | TOY 2L-II | LSX 46348 | | |
| LSX 46240 | 46600 | TOY 2LT LATE | | | |
| | 46602 | TOY 2L-T | LFF 46381 | 46381A | TOY S05C-II ALFIN |
| | 46351A | TOY 2LT NEW-II ALFIN | | | |
| LFF 46242 | 46242 | TOY 2D OLD | LFF 46613 | 46613 | TOY 1Z |
| LFF 46244 | 46244 | TOY 2D NEW | LSF 46613 | | |
| LFF 46256 | 46256 | TOY 3L | LSX 46654 | 46654A | TOY 1DZ ALFIN |
| LSF 46256 | | | LSX 46654 | 46684 | TOY 1DZ NEW |
| LSX 46256 | | | | | |
| LFX 46257 | 46257 | TOY 1HZ | LSF 46655 | 46655A | TOY 15BF ALFIN |
| LSF 46257 | 46268 | TOY 1HD-T LATE | LSX 46655 | 46656AG | TOY 15BF-T ALFIN GALLERY |
| LSX 46257 | 46325 | TOY 1HD-T-II | | | |
| | 46362AG | TOY 1HD-FT ALFIN GALLERY | LSF 46675 | 46675AG | TOY 1KD-FTV ALFIN GALLERY |
| | 46674AG | TOY 1HD-FTE ALFIN GALLERY | LSX 46675 | 46686AG | TOY 1KD-FTV-II ALFIN GALLERY |
| | | | | 46698AG | TOY 1KD-FTV-III ALFIN GALLERY |
| LFX 46260 | 46260 | TOY 2C | LSF 46676 | 46676AG | TOY 1ND-TV ALFIN GALLERY |
| LSF 46260 | 46264 | TOY 2C-II | LSX 46676 | | |
| LSX 46260 | 46278 | TOY 2C-T | | | |
| | 46601 | TOY 2C-III | LSF 46678 | 46678AG | TOY 1AD-FTV ALFIN GALLERY |
| | 46609 | TOY 2CT-II | LSX 46678 | 46679AG | TOY 2AD-FHV ALFIN GALLERY |
| | 46629A | TOY 3C ALFIN | | 46696AG | TOY 2AD-FTV ALFIN GALLERY |
| | 46695AG | TOY 2CT-III ALFIN GALLERY | | | |
| LFX 46273 | 46273 | TOY 5L | LSF 46680 | 46680AG | TOY 1CD-FTV ALFIN GALLERY |
| LSF 46273 | | | LSX 46680 | 46690AG | TOY 1CD-FTV-II ALFIN GALLERY |
| LSX 46273 | | | LFF 46682 | 46682 | TOY 2Z NEW |
| | | | LSF 46682 | | |
| | | | LFF 46685 | 46685 | TOY 13Z |
| | | | LSF 46685 | | |

CYLINDER LINER LIST

| TEIKIN LINER NUMBER | TEIKIN PISTON NUMBER | ENGINE MODEL | TEIKIN LINER NUMBER | TEIKIN PISTON NUMBER | ENGINE MODEL |
|---------------------|----------------------|----------------------------------|---------------------|-----------------------|---------------------|
| LSF 48601 | 48601A | VW 1G / 1V / CY TURBO ALFIN | LSF 62101 | 62101A | TAT INDICA ALFIN |
| | | | | 62104A | TAT ACE-II ALFIN |
| LSF 48602 | 48602A | VW 1X / 1Y / AAB ALFIN | LSF 62101-2 | 62101A-2 | TAT ACE ALFIN |
| | 48603A | VW AAZ / ABL / ADE TURBO ALFIN | | | |
| LFX 51102 | 51102 | HYU D4BB | LSF 62102 | 62102A | TAT 407 TURBO ALFIN |
| LSF 51102 | 51108 | HYU D4BA | LFF 63101 | 63101A | ALY 6ETI ALFIN |
| LSX 51102 | 51606AG | HYU D4BH ALFIN GALLERY | | 63102A | ALY 6DTI ALFIN |
| LSF 51103 | 51103 | HYU D4AF | 66101A | MAH SCORPIO CRD ALFIN | |
| LSX 51103 | 51607A | HYU D4AF-III ALFIN | LFF 64601 | 64601 | KOM 4D95 ALFIN |
| LSF 51112 | 51112 | HYU D4AE | LFF 64602 | 64602A | KOM 4D105 ALFIN |
| LSX 51112 | | | LSX 65002 | 65002A | EIC 483 TC ALFIN |
| LSF 51142 | 51142AG | HYU i20 MAGNA CRDI ALFIN GALLERY | | | |
| LSX 51142 | | | | | |
| LSF 51602 | 51602AG | HYU D4DA ALFIN GALLERY | | | |
| LSX 51602 | | | | | |
| LSF 51603 | 51603AG | HYU D4CB CRDI ALFIN GALLERY | | | |
| LSX 51603 | | | | | |
| LSF 51604 | 51604A | HYU D3EA ALFIN | | | |
| LSX 51604 | | | | | |
| LSF 51604-4 | 51604A-4 | HYU D4EA ALFIN | | | |
| LSX 51604-4 | | | | | |
| LSF 51605 | 51605AG | HYU D4EB-F/D4EB-G ALFIN GALLERY | | | |
| LSX 51605 | | | | | |
| LFF 52107 | 52107AG | KIA CARNIVAL-II ALFIN GALLERY | | | |
| LSF 52107 | | | | | |
| LSX 52107 | | | | | |
| LFF 52650 | 52650A | KIA RFA ALFIN | | | |
| LSF 52650 | | | | | |
| LFF 52651 | 52651A | KIA JT 3.0 ALFIN | | | |
| LSF 52651 | | | | | |
| LFF 52652 | 52652A | KIA JD K3500 ALFIN | | | |
| LSF 52652 | 52653G | KIA SH K3600 GALLERY | | | |
| | 52656G | KIA SH K3600 NEW-II GALLERY | | | |
| LSF 56606 | 56606A | OPE Y 17 DT/DTL ALFIN | | | |
| LSX 56606 | | | | | |



NOTES

A large, empty grid area for taking notes, consisting of a fine grid of light gray lines. The grid covers most of the page. At the bottom right, there is a decorative gradient element that transitions from a light blue color to white, curving upwards and to the right.



P.T. EDICO UTAMA
JALAN PULO GADUNG NO. 7
KAWASAN INDUSTRI
JAKARTA - 13920
INDONESIA

TEL : +62 (0)21 460 00 05

FAX : +62 (0)21 460 92 71

E-MAIL : MAIL@TEIKIN.COM

WEBSITE : WWW.TEIKIN.COM





SUITABLE FOR





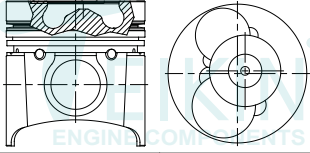

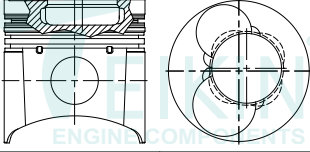
ASHOK LEYLAND

DIESEL

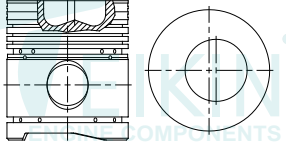

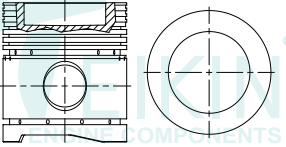

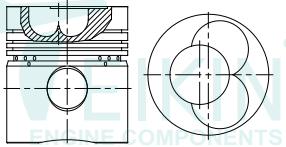
A

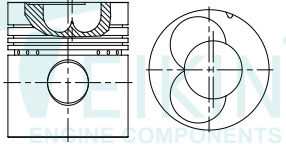
| ENGINE TYPE | PISTON | PISTON RING | PISTON PIN | PIN BUSHING | LINER | | LINER KIT SET |
|---|---|--|--|--|--|-----------|---------------------------------------|
| | | | | | FLANGED | NO FLANGE | |
| 6DTI 6 cyl.  Surface Treatment: Tin Coated Bore Clearance: MRC: 0.080 mm, MP: 25.00 mm | \varnothing 104.00 -20.5 CD 62.6 TL 108.6 | 1 - 3.0 FK 1 - 2.5 1 - 5.0 | \varnothing 37.00 TL 85.00  | | TL 200.0 OD 107.0 FT 8.0 FD 112.0 | | TEIKIN NO. LKFF 63102A 1 |
| | TEIKIN NO. 63102A REFERENCE NO. P0990351 | TEIKIN NO. R 63102 REFERENCE NO. | TEIKIN NO. P 36127 REFERENCE NO. | TEIKIN NO. B 63102 REFERENCE NO. | TEIKIN NO. LFF 63101 REFERENCE NO. | | |
| 6ETI 6 cyl.  Surface Treatment: Chromated Moly Skirt Bore Clearance: MRC: 0.050 mm, MP: 24.20 mm | \varnothing 104.00 -19.2 CD 60.2 TL 106.2 | 1 - 3.0 FK 1 - 2.5 1 - 3.0 | \varnothing 35.00 TL 85.00  | | TL 200.0 OD 107.0 FT 8.0 FD 112.0 | | TEIKIN NO. LKFF 63101A 2 |
| | TEIKIN NO. 63101A REFERENCE NO. P0959651 | TEIKIN NO. R 63101 REFERENCE NO. | TEIKIN NO. P 39166 REFERENCE NO. | TEIKIN NO. B 63101 REFERENCE NO. | TEIKIN NO. LFF 63101 REFERENCE NO. | | |

| ENGINE TYPE | PISTON | PISTON RING | PISTON PIN | PIN BUSHING | LINER | | LINER KIT SET |
|---|--|--------------------|---|-------------|---------|-----------|---------------|
| | | | | | FLANGED | NO FLANGE | |
| 330, J6, 103 6 cyl. | \varnothing 103.18 -21.5 CD 71.5 TL 118.2 | 3 - 2.4 2 - 4.8 | \varnothing 34.925 TL 88.00  | | | | TEIKIN NO. |
|  | TEIKIN NO. | | TEIKIN NO. | | | | |
| | 28101 | | P 28108P | | | | |
| Surface Treatment Bore Clearance Tin Coated MRC: 0.180 mm MP: 10.30 mm | REFERENCE NO. 497301 | | | | | | 1 |
| 103-II CNG APPLICATION 6 cyl. | \varnothing 103.18 -19.1 CD 69.3 TL 116.0 | 3 - 2.4 2 - 4.8 | \varnothing 34.925 TL 88.00  | | | | TEIKIN NO. |
|  | TEIKIN NO. | | TEIKIN NO. | | | | |
| | 28109 | | P 28108P | | | | |
| Surface Treatment Bore Clearance Tin Coated MRC: 0.180 mm MP: 10.30 mm | REFERENCE NO. | | | | | | 2 |
| 104 6 cyl. | \varnothing 104.78 -25.9 CD 71.00 TL 118.1 | 3 - 2.4 1 - 4.8 | \varnothing 34.925 TL 90.00  | | | | TEIKIN NO. |
|  | TEIKIN NO. | | TEIKIN NO. | | | | |
| | 28108 | | P 28108 | | | | |
| Surface Treatment Bore Clearance Tin Coated MRC: 0.150 mm MP: 13.50 mm | REFERENCE NO. 2701E-6110 | | | | | | 3 |
| 107 6 cyl. | \varnothing 107.21 -26.7 CD 71.2 TL 119.9 | 3 - 2.4 1 - 4.8 | \varnothing 36.512 TL 90.00  | | | | TEIKIN NO. |
|  | TEIKIN NO. | | TEIKIN NO. | | | | |
| | 28107 | | P 28107 | | | | |
| Surface Treatment Bore Clearance Tin Coated MRC: 0.110 mm MP: 15.00 mm | REFERENCE NO. 703F-6110-AAC | | | | | | 4 |

B

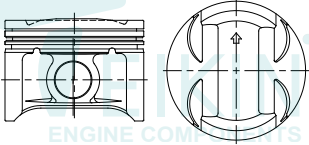
| ENGINE TYPE | PISTON | PISTON RING | PISTON PIN | PIN BUSHING | LINER | | LINER KIT SET |
|--|--|--------------------------------|------------------------------|-------------|---------|-----------|---------------|
| | | | | | FLANGED | NO FLANGE | |
| M 20 B 20 L 1991 cc M20B20 M1 Z7 KAT 6 cyl. 320/6 1977-82, 320i 1982-91 520i 1988-91 | Ø 80.00 +2.1 CD 43.4 TL 70.6 | 1 - 1.5 1 - 2.0 1 - 3.5 | Ø 22.000 TL 62.00 | | | | TEIKIN NO. |
| | TEIKIN NO. 54101 | | TEIKIN NO. P 43222 | | | | |
| Surface Treatment Tin Coated Bore Clearance MRC: 0.030 mm MP: 6.50 mm | REFERENCE NO. KS : 92 985 600 | | | | | | 1 |
| M 20 B 25 M1 Z7 KAT 2494 cc Z1 2.5 1988-91 6 cyl. 325i 1986-93, 525i 1988-91 | Ø 84.00 -6.4 CD 34.5 TL 69.4 | 1 - 1.5 1 - 1.75 1 - 3.0 | Ø 22.000 TL 55.00 | | | | TEIKIN NO. |
| | TEIKIN NO. 54102 | | TEIKIN NO. P 48102 | | | | |
| Surface Treatment Tin Coated Bore Clearance MRC: 0.030 mm MP: 15.00 mm | REFERENCE NO. KS : 93 127 600 | | | | | | 2 |

| ENGINE TYPE | PISTON | PISTON RING | PISTON PIN | PIN BUSHING | LINER | | LINER KIT SET |
|---|--|-------------------------------|---|-------------|---------|-----------|---------------|
| | | | | | FLANGED | NO FLANGE | |
| TIGGO 1600 cc 4 cyl.  | \varnothing 81.00 +0.9 CD 34.7 TL 59.6 | 1 - 1.2 1 - 1.5 1 - 2.5 | \varnothing 21.000 TL 54.00  | | | | TEIKIN NO. |
| | TEIKIN NO. 33101 | | TEIKIN NO. P 33101 | | | | |
| | REFERENCE NO. 481H-1004020 | | | | | | |
| Surface Treatment Moly Skirt | Bore Clearance MRC: 0.030 mm MP: 10.50 mm | | | | | | 1 |







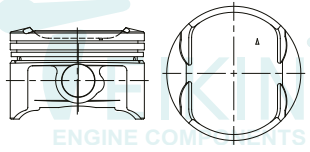

SUITABLE FOR

CHEVROLET

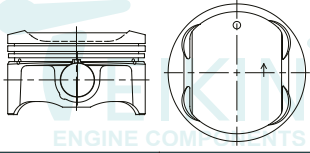
GASOLINE

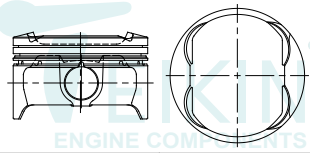

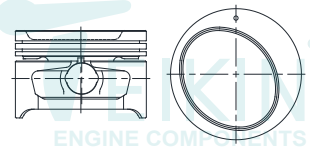

| ENGINE TYPE | PISTON | PISTON RING | PISTON PIN | PIN BUSHING | LINER | | LINER KIT SET |
|---|--|-------------------------------|--|-------------|---------|-----------|---------------|
| | | | | | FLANGED | NO FLANGE | |
| SPARK GT 1.2 1200 cc 4 cyl. | \emptyset 69.70 +2.3 CD 25.3 TL 47.6 | 2 - 1.2 1 - 2.0 | \emptyset 17.00 TL 53.00  | | | | TEIKIN NO. |
|  | TEIKIN NO. 30109 | | TEIKIN NO. P 49106 | | | | |
| Surface Treatment Bore Clearance Moly Skirt MRC: 0.030 mm MP: 7.50 mm | REFERENCE NO. 96897461 | | | | | | 1 |
| SAIL 1.4 L 1400 cc 4 cyl. | \emptyset 73.80 +2.2 CD 24.3 TL 45.1 | 2 - 1.2 1 - 2.0 | \emptyset 18.00 TL 47.50  | | | | TEIKIN NO. |
|  | TEIKIN NO. 30110 | | TEIKIN NO. P 30110 | | | | |
| Surface Treatment Bore Clearance Moly Skirt MRC: 0.030 mm MP: 5.30 mm | REFERENCE NO. 2410-2246 | | | | | | 2 |
| SPIN 1.5 4 cyl. | \emptyset 74.71 +2.7 CD 25.5 TL 48.2 | 1 - 1.0 1 - 1.2 1 - 2.0 | \emptyset 18.00 TL 47.50  | | | | TEIKIN NO. |
|  | TEIKIN NO. 30114 | | TEIKIN NO. P 30110 | | | | |
| Surface Treatment Bore Clearance Moly Skirt MRC: 0.030 mm MP: 9.50 mm | REFERENCE NO. 25190026 | | | | | | 3 |
| AVEO 4 cyl. | \emptyset 76.50 -5.3 CD 28.0 TL 51.0 | 2 - 1.5 1 - 3.0 | \emptyset 18.00 TL 56.00  | | | | TEIKIN NO. |
|  | TEIKIN NO. 30104 | | TEIKIN NO. P 30104 | | | | |
| Surface Treatment Bore Clearance Tin Coated MRC: 0.030 mm MP: 8.00 mm | REFERENCE NO. 96335640 | | | | | | 4 |



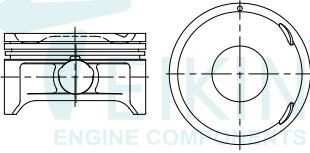
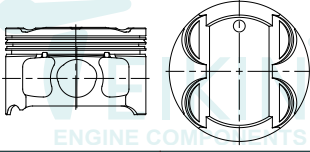

SUITABLE FOR

CHEVROLET

GASOLINE

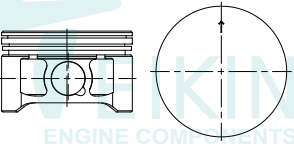

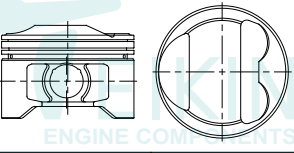
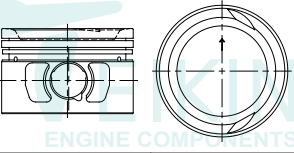

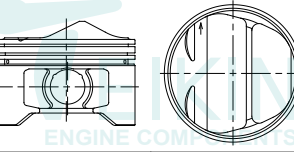

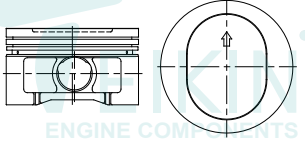
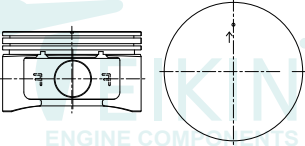
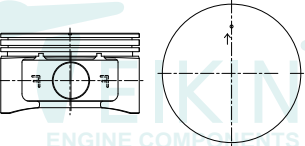
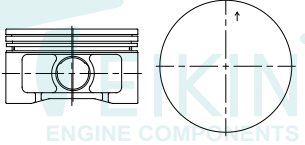
| ENGINE TYPE | PISTON | PISTON RING | PISTON PIN | PIN BUSHING | LINER | | LINER KIT SET | | |
|---|--|-------------------------------|--|-------------|---------|-----------|---|------------------------------|----|
| | | | | | FLANGED | NO FLANGE | | | |
| CAPTIVA 2.4 L 2400 cc 4 cyl.  Surface Treatment: Tin Coated, Moly Skirt Bore Clearance: MRC: 0.030 mm, MP: 10.00 mm | Ø 87.50 -6.1 CD 27.0 TL 50.1 | 1 - 1.2 1 - 1.5 1 - 2.5 | Ø 21.000 TL 61.50 | | | | TEIKIN NO. 30111 REFERENCE NO. 92067744 | TEIKIN NO. P 56104 | 9 |
| CAPTIVA 3.2 6 cyl.  Surface Treatment: Moly Skirt Bore Clearance: MRC: 0.030 mm, MP: 8.50 mm | Ø 89.00 +0.4 CD 32.0 TL 55.4 | 1 - 1.2 1 - 1.5 1 - 2.5 | Ø 24.000 TL 60.00  | | | | TEIKIN NO. 30113 REFERENCE NO. 92068448 | TEIKIN NO. P 30113 | 10 |

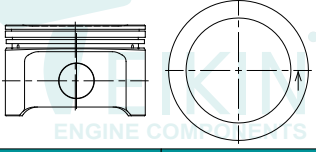
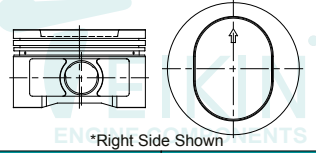
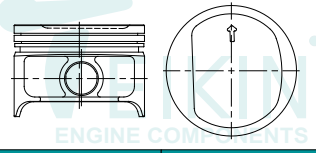
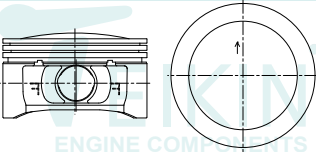
| ENGINE TYPE | PISTON | PISTON RING | PISTON PIN | PIN BUSHING | LINER | | LINER KIT SET |
|--|--|-------------------------------|---|-------------|---------|-----------|---------------|
| | | | | | FLANGED | NO FLANGE | |
| 2.7 L 2736 cc 6 cyl. INTERPID CONCORDE F.I., DOHC 24 V  | \emptyset 86.00 CD 31.2 TL 53.2 | 2 - 1.5 1 - 3.0 | \emptyset 22.000 TL 60.00  | | | | TEIKIN NO. |
| Surface Treatment Bore Clearance Moly Skirt Anodized Crown 1st Ring Anodized | MRC: 0.020 mm MP: 8.50 mm | | | | | | |
| | REFERENCE NO. 05018627AB 5018627AC | | | | | | |
| | TEIKIN NO. 31117 | | TEIKIN NO. P 34102 | | | | 1 |
| 2.4 L 2429 cc 4 cyl. CIRRUS / STRATUS BREEZE, SEBRING F.I., DOHC 16 V 1997-00  | \emptyset 87.50 CD 30.4 TL 61.5 | 1 - 1.2 1 - 1.5 1 - 3.0 | \emptyset 22.000 TL 72.60 | | | | TEIKIN NO. |
| Surface Treatment Bore Clearance Tin Coated | MRC: 0.020 mm MP: 9.50 mm | | | | | | |
| | REFERENCE NO. 4897660AA | | | | | | |
| | TEIKIN NO. 31116 | | TEIKIN NO. P 31116 | | | | 2 |
| 2.5 L 2507 cc 4 cyl. SPIRIT / SHADOW TURBO DAYTONA, SUNDANCE F.I., SOHC 8V 1989-95  | \emptyset 87.50 CD 34.5 TL 56.5 | 2 - 1.5 1 - 4.0 | \emptyset 22.885 TL 69.00  | | | | TEIKIN NO. |
| Surface Treatment Bore Clearance Tin Coated | MRC: 0.030 mm MP: 6.50 mm | | | | | | |
| | REFERENCE NO. 4637664 | | | | | | |
| | TEIKIN NO. 31115 | | TEIKIN NO. P 31115 | | | | 3 |
| EDZ 2429 cc 4 cyl. CARAVAN, VOYAGER PT CRUISER, SEBRING STRATUS F.I., DOHC 16 V  | \emptyset 87.50 CD 30.2 TL 66.3 | 2 - 1.5 1 - 3.0 | \emptyset 22.000 TL 72.60 | | | | TEIKIN NO. |
| Surface Treatment Bore Clearance Tin Coated | MRC: 0.020 mm MP: 9.50 mm | | | | | | |
| | REFERENCE NO. 5066565AA | | | | | | |
| | TEIKIN NO. 31118 | | TEIKIN NO. P 31116 | | | | 4 |

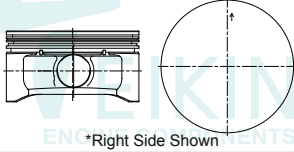
| ENGINE TYPE | PISTON | PISTON RING | PISTON PIN | PIN BUSHING | LINER | | LINER KIT SET |
|--|--|-------------------------------|--------------------------------|-------------|---------|-----------|---------------|
| | | | | | FLANGED | NO FLANGE | |
| MOT. 201 3300 cc 6 cyl. GRAND VOYAGER VOYAGER, TOWN & COUNTRY 1991-2000 | \emptyset 93.00 -2.3 CD 31.7 TL 53.6 | 2 - 1.5 1 - 3.0 | \emptyset 22.885 TL 67.50 | | | | TEIKIN NO. |
|  | TEIKIN NO. 31120 | | TEIKIN NO. P 31120 | | | | |
| Surface Treatment Bore Clearance Moly Skirt MRC: 0.030 mm MP: 7.00 mm | REFERENCE NO. 4897772AA 5241057 | | | | | | 5 |
| POWER TECH 3.7 6 cyl. | \emptyset 93.00 CD 31.8 TL 53.9 | 2 - 1.5 1 - 3.0 | \emptyset 24.020 TL 59.00 | | | | TEIKIN NO. |
|  | TEIKIN NO. 31130-6 | | TEIKIN NO. P 31130 | | | | |
| Surface Treatment Bore Clearance Moly Skirt MRC: 0.030 mm MP: 7.00 mm | REFERENCE NO. 5019316AA | | | | | | 6 |
| POWER TECH 4.7 8 cyl. | \emptyset 93.00 CD 31.8 TL 53.9 | 2 - 1.5 1 - 3.0 | \emptyset 24.020 TL 59.00 | | | | TEIKIN NO. |
|  | TEIKIN NO. 31130 | | TEIKIN NO. P 31130 | | | | |
| Surface Treatment Bore Clearance Moly Skirt MRC: 0.030 mm MP: 7.00 mm | REFERENCE NO. 5019316AA | | | | | | 7 |
| EGH 3778 cc 6 cyl. PACIFICA 2005-2007 CARAVAN 2000-2008 GRAND CARAVAN 2001-2002 TOWN & COUNTRY 2001-2008 | \emptyset 96.00 CD 32.3 TL 54.1 | 1 - 1.2 1 - 1.5 1 - 3.0 | \emptyset 22.885 TL 71.50 | | | | TEIKIN NO. |
|  | TEIKIN NO. 31121 | | TEIKIN NO. P 31119 | | | | |
| Surface Treatment Bore Clearance Moly Skirt MRC: 0.030 mm MP: 6.50 mm | REFERENCE NO. 5019338AA 4666129AA | | | | | | 8 |

| ENGINE TYPE | PISTON | PISTON RING | PISTON PIN | PIN BUSHING | LINER | | LINER KIT SET |
|--|--|-------------------------------|---|-------------|---------|-----------|---------------|
| | | | | | FLANGED | NO FLANGE | |
| EGJ 3518 cc 6 cyl. PACIFICA 2002-2007 SEBRING 2007-2008 SOHC V6 24 V | \emptyset 96.00 -0.6 CD 38.2 TL 62.2 | 1 - 1.2 1 - 1.5 1 - 3.0 | \emptyset 24.000 TL 61.00  | | | | TEIKIN NO. |
|  | TEIKIN NO. | | TEIKIN NO. | | | | 9 |
| Surface Treatment Bore Clearance Moly Skirt Anodized Crown 1st Ring Anodized MRC: 0.030 mm MP: 9.00 mm | 31122 | | P 46300 | | | | |
| REFERENCE NO. | 5102235AA | | | | | | |
| MOT. 232 3800 cc 6 cyl. GRAND VOYAGER TOWN & COUNTRY 1994-2000 | \emptyset 96.00 -4.9 CD 34.9 TL 56.6 | 2 - 1.5 1 - 3.0 | \emptyset 22.885 TL 71.50 | | | | TEIKIN NO. |
|  | TEIKIN NO. | | TEIKIN NO. | | | | 10 |
| Surface Treatment Bore Clearance Moly Skirt MRC: 0.030 mm MP: 6.00 mm | 31119 | | P 31119 | | | | |
| REFERENCE NO. | 4797692 | | | | | | |
| 153 2507 cc 4 cyl. 1996-2002 | \emptyset 98.43 -2.6 CD 40.5 TL 69.2 | 2 - 1.5 1 - 4.0 | \emptyset 23.640 TL 68.50 | | | | TEIKIN NO. |
|  | TEIKIN NO. | | TEIKIN NO. | | | | 11 |
| Surface Treatment Bore Clearance Moly Skirt MRC: 0.030 mm MP: 13.00 mm | 31124 | | P 31124 | | | | |
| REFERENCE NO. | | | | | | | |
| HEMI 5.7 8 cyl. | \emptyset 99.50 +4.0 CD 30.7 TL 58.7 | 2 - 1.5 1 - 3.0 | \emptyset 24.000 TL 71.00 | | | | TEIKIN NO. |
|  | TEIKIN NO. | | TEIKIN NO. | | | | 12 |
| Surface Treatment Bore Clearance Anodized Crown Moly Skirt 1st Ring Anodized MRC: 0.030 mm MP: 8.00 mm | 31131 | | P 31131 | | | | |
| REFERENCE NO. | 05086011AB | | | | | | |

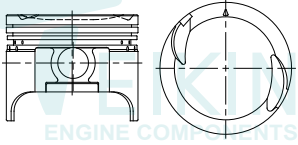
| ENGINE TYPE | PISTON | PISTON RING | PISTON PIN | PIN BUSHING | LINER | | LINER KIT SET |
|---|---|--------------------|---|-------------|---------|-----------|-------------------|
| | | | | | FLANGED | NO FLANGE | |
| 370 CID 6059 cc 8 cyl. DODGE JEEP 6.1L V8 HEMI, 2005-2010 | \varnothing 103.00 CD 31.0 TL 55.0 | 2 - 1.5 1 - 3.0 | \varnothing 25.000 TL 65.00  | | | | TEIKIN NO. |
|  *Right Side Shown | TEIKIN NO. | | TEIKIN NO. | | | | |
| Surface Treatment Bore Clearance Moly Skirt MRC: 0.030 mm Anodized Crown MP: 7.00 mm 1st Ring Anodized | | | | | | | |
| | REFERENCE NO. | | | | | | |
| | | | | | | | 13 |

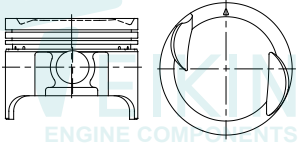
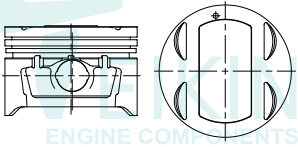
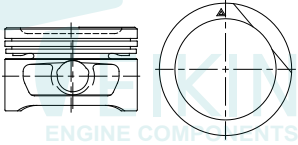
| ENGINE TYPE | PISTON | PISTON RING | PISTON PIN | PIN BUSHING | LINER | | LINER KIT SET |
|---|--|-----------------------------------|-------------------------------|---|---------|-----------|---------------|
| | | | | | FLANGED | NO FLANGE | |
| F8C TICO, DAMAS | 800 cc 3 cyl. | \emptyset 68.50 -2.5 | 1 - 1.2 1 - 1.5 1 - 2.8 | \emptyset 16.000 TL 52.50  | | | TEIKIN NO. |
|  | | | | | | | |
| Surface Treatment None | Bore Clearance MRC: 0.030 mm MP: 17.00 mm | | | | | | |
| | | | | | | | 1 |
| MATIZ II B10S | 1000 cc 4 cyl. | \emptyset 68.50 -1.0 | 2 - 1.2 1 - 2.5 | \emptyset 17.000 TL 53.00  | | | TEIKIN NO. |
|  | | | | | | | |
| Surface Treatment None | Bore Clearance MRC: 0.030 mm MP: 14.50 mm | | | | | | |
| | | | | | | | 2 |
| CIELO 1.5 A15MF DOHC | 1500 cc 4 cyl. | \emptyset 76.50 +0.6 | 2 - 1.5 1 - 3.0 | \emptyset 18.000 TL 56.00 | | | TEIKIN NO. |
|  | | | | | | | |
| Surface Treatment Tin Coated | Bore Clearance MRC: 0.030 mm MP: 7.50 mm | | | | | | |
| | | | | | | | 3 |
| LE MANS 1.5 CIERO, LANOS, CIELO SOHC | 1500 cc 4 cyl. | \emptyset 76.50 +0.35 | 2 - 1.5 1 - 3.0 | \emptyset 18.000 TL 56.00 | | | TEIKIN NO. |
|  | | | | | | | |
| Surface Treatment Tin Coated | Bore Clearance MRC: 0.030 mm MP: 6.00 mm | | | | | | |
| | | | | | | | 4 |

D

SUITABLE FOR

DAEWOO

GASOLINE

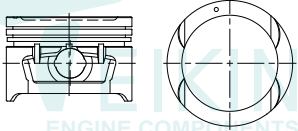
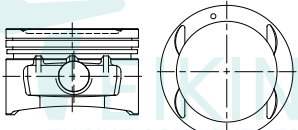

| ENGINE TYPE | PISTON | PISTON RING | PISTON PIN | PIN BUSHING | LINER | | LINER KIT SET | |
|---|--|-------------------------------|-----------------------------|-------------|---------|-----------|---|----------|
| | | | | | FLANGED | NO FLANGE | | |
| NUBIRA-II 4 cyl.  Surface Treatment: Tin Coated Bore Clearance: MRC: 0.030 mm, MP: 8.00 mm | Ø 76.50 -2.0 CD 28.3 TL 51.3 | 2 - 1.5 1 - 3.0 | Ø 18.000 TL 56.00 | | | | TEIKIN NO. 49105 TEIKIN NO. P 30104 REFERENCE NO. 96182814 93740215/16 93740221/22 S1220010/11/28/29 | 5 |
| NUBIRA 4 cyl. A16DM A16MF  Surface Treatment: Tin Coated Bore Clearance: MRC: 0.030 mm, MP: 8.00 mm | Ø 79.00 -2.9 CD 28.4 TL 51.3 | 1 - 1.2 1 - 1.5 1 - 3.0 | Ø 18.000 TL 56.00 | | | | TEIKIN NO. 49102 TEIKIN NO. P 30104 REFERENCE NO. 96182846 93740129 93740219/20 S1220019 | 6 |

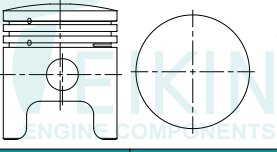
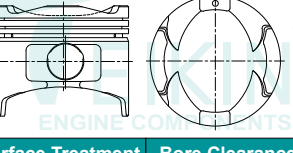
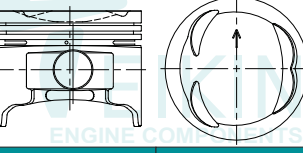
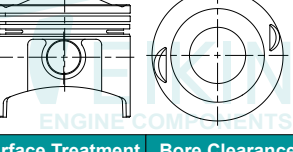
| ENGINE TYPE | PISTON | PISTON RING | PISTON PIN | PIN BUSHING | LINER | | LINER KIT SET |
|---|--|-------------------------------|---|-------------|---------|-----------|---------------|
| | | | | | FLANGED | NO FLANGE | |
| S-38P (NEW) 356 cc L-38 FELLOW (OLD) 2 cyl. | \varnothing 62.00 +5.0 CD 32.0 TL 71.0 | 1 - 2.0 HK 2 - 2.0 | \varnothing 17.000 TL 53.00  | | | | TEIKIN NO. |
|  | TEIKIN NO. 32106 | | TEIKIN NO. P 49106 | | | | |
| Surface Treatment Bore Clearance None MRC: 0.030 mm MP: 20.00 mm | REFERENCE NO. 13101-87207 | | | | | | 1 |
| KANCIL 850 CC NEW 846 cc 3 cyl. | \varnothing 66.60 -5.0 CD 28.5 TL 56.5 | 2 - 1.2 1 - 2.0 | \varnothing 18.000 TL 53.00 | | | | TEIKIN NO. |
|  | TEIKIN NO. 32146 | | TEIKIN NO. P 46332 | | | | |
| Surface Treatment Bore Clearance Anodized Crown MRC: 0.030 mm MP: 16.50 mm | REFERENCE NO. 13101-87Z13-010 | | | | | | 2 |
| EF 3 cyl. | \varnothing 68.00 -5.2 CD 28.0 TL 55.0 | 1 - 1.2 1 - 1.5 1 - 2.8 | \varnothing 18.000 TL 50.00 | | | | TEIKIN NO. |
|  | TEIKIN NO. 32150 | | TEIKIN NO. P 45136 | | | | |
| Surface Treatment Bore Clearance None MRC: 0.030 mm MP: 15.00 mm | REFERENCE NO. 13101-87216 | | | | | | 3 |
| CD 843 cc 3 cyl. | \varnothing 70.00 +4.3 CD 28.0 TL 64.3 | 2 - 1.5 1 - 2.8 | \varnothing 18.000 TL 60.00 | | | | TEIKIN NO. |
|  | TEIKIN NO. 32601 (32141) | | TEIKIN NO. P 32601 | | | | |
| Surface Treatment Bore Clearance Tin Coated MRC: 0.043 mm MP: 14.00 mm | REFERENCE NO. 13101-87717 13101-87708 13101-87731 | | | | | | 4 |



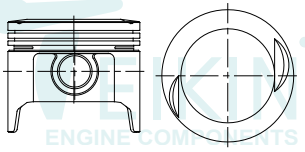
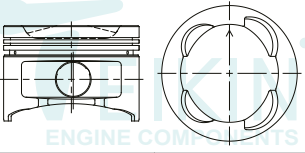
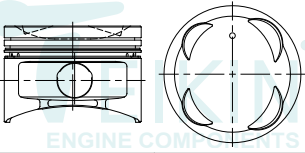
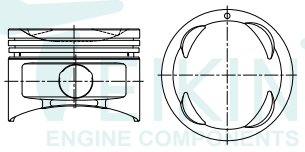

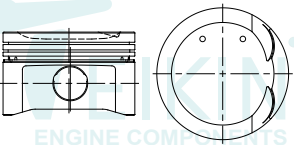
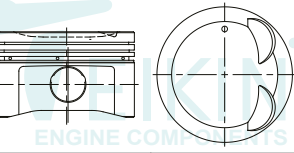
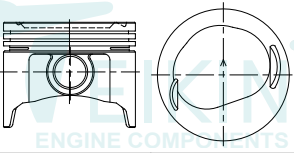
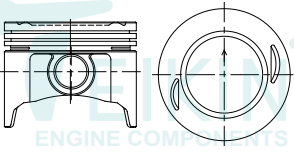

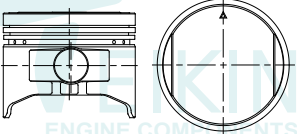
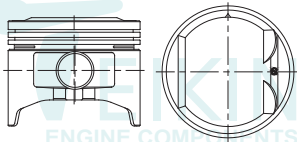
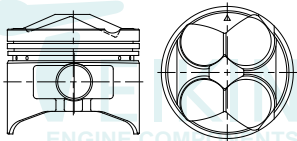

D

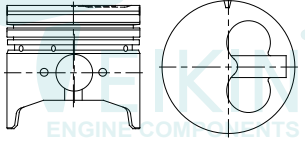
| ENGINE TYPE | PISTON | PISTON RING | PISTON PIN | PIN BUSHING | LINER | | LINER KIT SET | | |
|---|---|-----------------------|----------------------|-------------|---------|-----------|---|---|--|
| | | | | | FLANGED | NO FLANGE | | | |
| S-10P 547 cc 2 cyl. AB  TEIKIN ENGINE COMPONENTS | Ø 71.60 +0.8 CD 30.3 TL 62.6 | 2 - 1.5 1 - 2.8 | Ø 18.000 TL 61.00 | | | | TEIKIN NO. REFERENCE NO. 13101-87022 13101-87715 13101-87732 13101-87701 | 5 | |
| | TEIKIN NO. 32110 | TEIKIN NO. P 43187 | | | | | | | |
| | Surface Treatment Bore Clearance None MRC: 0.030 mm MP: 16.00 mm | | | | | | | | |
| | | | | | | | | | |
| EJ-DE / EJ-EV 989 cc 3 cyl. DOHC 12V  TEIKIN ENGINE COMPONENTS | Ø 72.00 -6.8 CD 28.5 TL 50.6 | 2 - 1.2 1 - 2.5 | Ø 18.000 TL 52.00 | | | | TEIKIN NO. REFERENCE NO. 13101-97201 13102-97201 13103-97201 | 6 | |
| | TEIKIN NO. 32605 | TEIKIN NO. P 32605 | | | | | | | |
| | Surface Treatment Bore Clearance Anodized Crown MRC: 0.030 mm MP: 10.00 mm | | | | | | | | |
| | | | | | | | | | |
| EJ-VE-II 1000 cc 3 cyl. XENIA NEW  TEIKIN ENGINE COMPONENTS | Ø 72.00 -6.8 CD 28.6 TL 50.6 | 2 - 1.2 1 - 2.0 | Ø 18.000 TL 53.00 | | | | TEIKIN NO. REFERENCE NO. 13101-BZ090-031 | 7 | |
| | TEIKIN NO. 32151 | TEIKIN NO. P 46332 | | | | | | | |
| | Surface Treatment Bore Clearance Tin Coated MRC: 0.030 mm Anodized Crown MP: 10.00 mm 1st Ring Anodized | | | | | | | | |
| | | | | | | | | | |
| KELISA 1000 CC 989 cc 3 cyl.  TEIKIN ENGINE COMPONENTS | Ø 72.00 -6.8 CD 28.7 TL 50.6 | 2 - 1.2 1 - 2.5 | Ø 18.000 TL 53.00 | | | | TEIKIN NO. REFERENCE NO. 13101-87Z11-01 | 8 | |
| | TEIKIN NO. 32147 | TEIKIN NO. P 46332 | | | | | | | |
| | Surface Treatment Bore Clearance Tin Coated MRC: 0.030 mm Anodized Crown MP: 10.00 mm | | | | | | | | |
| | | | | | | | | | |

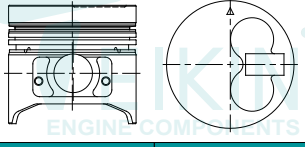
| ENGINE TYPE | PISTON | PISTON RING | PISTON PIN | PIN BUSHING | LINER | | LINER KIT SET |
|---|--|------------------------|-----------------------|-------------|---------|-----------|---------------|
| | | | | | FLANGED | NO FLANGE | |
| K3-DE 1300 cc DAIHATSU GRAND MAX 1.3 L 4 cyl. | Ø 72.00 -3.8 CD 28.0 TL 45.5 | 2 - 1.2 1 - 2.0 | Ø 18.000 TL 53.00 | | | | TEIKIN NO. |
|  | TEIKIN NO. 32144 | | TEIKIN NO. P 46332 | | | | |
| Surface Treatment Tin Coated Bore Clearance MRC: 0.030 mm MP: 5.70 mm | REFERENCE NO. 13101-BZ180-001 | | | | | | 9 |
| K3-VE-II 1297 cc 4 cyl. | Ø 72.00 -2.8 CD 28.1 TL 45.2 | 2 - 1.2 1 - 2.0 | Ø 18.000 TL 54.00 | | | | TEIKIN NO. |
|  | TEIKIN NO. 32606 | | TEIKIN NO. P 58107 | | | | |
| Surface Treatment Anodized Crown Tin Coated Bore Clearance MRC: 0.030 mm MP: 5.30 mm | REFERENCE NO. 13101-97403 13103-97403 | | | | | | 10 |
| G11 993 cc CB 3 cyl. | Ø 76.00 -4.0 CD 28.5 TL 60.6 | 2 - 1.5 1 - 2.8 | Ø 18.000 TL 61.00 | | | | TEIKIN NO. |
|  | TEIKIN NO. 32117 | | TEIKIN NO. P 43187 | | | | |
| Surface Treatment None Bore Clearance MRC: 0.030 mm MP: 17.50 mm | REFERENCE NO. 13101-87719 13101-87709/13/9 13101-87729 13211-87719/29 | | | | | | 11 |
| S75 993 cc CB 3 cyl. | Ø 76.00 -1.4 CD 28.5 TL 60.5 | 2 - 1.5 1 - 2.8 | Ø 18.000 TL 61.00 | | | | TEIKIN NO. |
|  | TEIKIN NO. 32124 | | TEIKIN NO. P 43187 | | | | |
| Surface Treatment None Bore Clearance MRC: 0.030 mm MP: 15.00 mm | REFERENCE NO. 13101-87730 13101-87736 13211-87711 13101-87703 | | | | | | 12 |

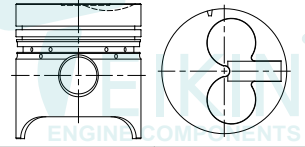
D

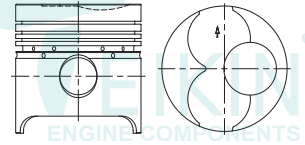
| ENGINE TYPE | PISTON | PISTON RING | PISTON PIN | PIN BUSHING | LINER | | LINER KIT SET |
|--|--|-------------------------------|--------------------------------|-------------|---------|-----------|---------------|
| | | | | | FLANGED | NO FLANGE | |
| HD 1589 cc FEROZA 4 cyl. | \emptyset 76.00 +0.5 CD 30.2 TL 60.7 | 1 - 1.2 1 - 1.5 1 - 3.0 | \emptyset 19.000 TL 58.00 | | | | TEIKIN NO. |
|  | TEIKIN NO. 32142 | | TEIKIN NO. P 32125 | | | | |
| Surface Treatment None Bore Clearance MRC: 0.030 mm MP: 16.40 mm | REFERENCE NO. 13101-87113 13101-87106 13101-87108 | | | | | | 13 |
| S89 1295 cc HC DK 105 4 cyl. | \emptyset 76.00 +2.6 CD 30.3 TL 62.9 | 1 - 1.2 1 - 1.5 1 - 3.0 | \emptyset 19.000 TL 58.00 | | | | TEIKIN NO. |
|  | TEIKIN NO. 32125 | | TEIKIN NO. P 32125 | | | | |
| Surface Treatment None Bore Clearance MRC: 0.030 mm MP: 17.00 mm | REFERENCE NO. 13101-87107 13101-87105 13211-87105 13211-87111 | | | | | | 14 |
| S89-II 4 cyl. | \emptyset 76.00 +8.5 CD 30.3 TL 68.8 | 1 - 1.2 1 - 1.5 1 - 3.0 | \emptyset 19.000 TL 58.00 | | | | TEIKIN NO. |
|  | TEIKIN NO. 32145 | | TEIKIN NO. P 32125 | | | | |
| Surface Treatment Anodized Crown Bore Clearance MRC: 0.030 mm MP: 16.00 mm | REFERENCE NO. 13101-87Z14 13103-87Z14 13104-87Z14 13105-87Z14 | | | | | | 15 |

| ENGINE TYPE | PISTON | PISTON RING | PISTON PIN | PIN BUSHING | LINER | | LINER KIT SET | | | |
|--|--|----------------------------------|---|------------------------------|---|---------------|---|--|---|-------------------------------------|
| | | | | | FLANGED | NO FLANGE | | | | |
| CL 993 cc 3 cyl. G30 1984  Surface Treatment Bore Clearance Tin Coated MRC: 0.030 mm MP: 18.90 mm | \emptyset 76.00 -1.0 CD 38.5 TL 70.5 | 1 - 2.0 HK 1 - 1.5 1 - 3.0 | \emptyset 21.000 TL 63.50  | | TL 140.0 OD 80.0 FT 4.8 FD 83.0 | 140.0 80.0 | TEIKIN NO. LKSF 32120 LKXS 32120 LKSF 32120A LKXS 32120A | | | |
| | TEIKIN NO. 32120 32120A | TEIKIN NO. R 32120 | TEIKIN NO. P 32120 | | TEIKIN NO. LSF 32120 LSX 32120 | | REFERENCE NO. 13101-87725 13101-87727 13102-87712 | REFERENCE NO. 13011-87717 13011-87723A | REFERENCE NO. 11461-87703 | |
| | | | | | | | | | | |
| | | | | | | | | | | |
| CL-T 993 cc 3 cyl.  Surface Treatment Bore Clearance Tin Coated MRC: 0.050 mm MP: 14.50 mm | \emptyset 76.00 -1.4 CD 40.5 TL 70.5 | 1 - 2.0 HK 1 - 1.5 1 - 3.0 | \emptyset 23.000 TL 64.50  | | TL 140.0 OD 80.0 FT 4.8 FD 83.0 | 140.0 80.0 | TEIKIN NO. LKSF 32602 LKXS 32602 LKSF 32602A LKXS 32602A | | | |
| | TEIKIN NO. 32602 32602A (32140) | TEIKIN NO. R 32120 | TEIKIN NO. P 32602 | | TEIKIN NO. LSF 32120 LSX 32120 | | REFERENCE NO. 13101-87720 13102-87711 | REFERENCE NO. 13011-87717 13011-87723A | REFERENCE NO. 11461-87703 | |
| | | | | | | | | | | |
| | | | | | | | | | | |
| DG 2530 cc 4 cyl. DELTA TRUCK NEW V 22 H DIESEL DV 24 DELTA 88  Surface Treatment Bore Clearance Tin Coated MRC: 0.080 mm MP: 22.50 mm | \emptyset 88.00 -5.5 CD 50.5 TL 95.0 | 1 - 2.5 1 - 2.0 1 - 4.0 | \emptyset 26.000 TL 70.00  | | TL 182.0 OD 93.0 FT 3.0 +1.0 FD 97.0 | 182.0 93.0 | TEIKIN NO. LKFF 32102 LKSF 32102 | | | |
| | TEIKIN NO. 32102 | TEIKIN NO. R 32102 | TEIKIN NO. P 32139 | TEIKIN NO. B 32102 | TEIKIN NO. LFF 32102 LSF 32102 | | REFERENCE NO. 13101-87306 13101-87309 | REFERENCE NO. 13011-87305 13011-87306 13011-87307 13011-87308 | REFERENCE NO. 90043-84001/4 90043-84018/50 90043-84057 90043-84105 | REFERENCE NO. 11461-87302 |
| | | | | | | | | | | |
| | | | | | | | | | | |
| DG OLD-4R 2530 cc 4 cyl. DV26 4R 1972 D300N  Surface Treatment Bore Clearance Tin Coated MRC: 0.100 mm MP: 14.50 mm | \emptyset 88.00 -5.3 CD 50.5 TL 90.5 | 3 - 2.0 1 - 4.0 | \emptyset 26.000 TL 70.00  | | TL 182.0 OD 93.0 FT 3.0 +1.0 FD 97.0 | 182.0 93.0 | TEIKIN NO. LKFF 32103 LKSF 32103 | | | |
| | TEIKIN NO. 32103 | TEIKIN NO. R 32103 | TEIKIN NO. P 32139 | TEIKIN NO. B 32102 | TEIKIN NO. LFF 32102 LSF 32102 | | REFERENCE NO. 13101-87305 13211-87305 | REFERENCE NO. 13011-87304 | REFERENCE NO. 90043-84001/4 90043-84018/50 90043-84057 90043-84105 | REFERENCE NO. 11461-87302 |
| | | | | | | | | | | |
| | | | | | | | | | | |

D

16

17





18



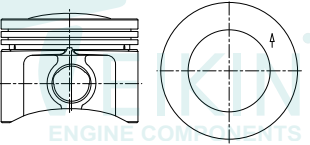
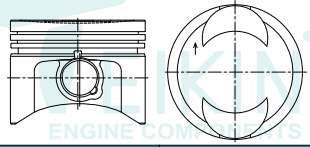
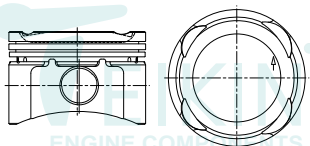
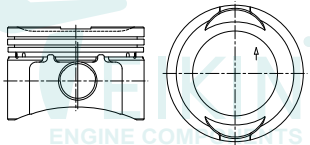

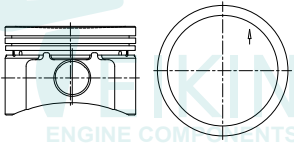
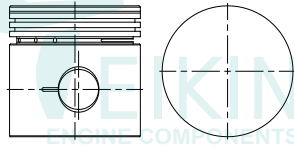
19

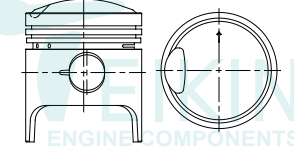
| ENGINE TYPE | PISTON | PISTON RING | PISTON PIN | PIN BUSHING | LINER | | LINER KIT SET |
|---|--|--|---|--|--|-----------|---|
| | | | | | FLANGED | NO FLANGE | |
| DV26 5R 2530 cc DG OLD-5R 4 cyl. | \varnothing 88.00 -5.3 CD 50.5 TL 90.5 | 3 - 2.0 2 - 4.0 | \varnothing 26.000 TL 70.00 | | TL 182.0 OD 93.0 FT 7.0 +1.0 FD 97.0 | | TEIKIN NO. LKFF 32139 LKSF 32139 |
| ENGINE COMPONENTS | TEIKIN NO. 32139 | TEIKIN NO. R 32139 | TEIKIN NO. P 32139 | TEIKIN NO. B 32102 | TEIKIN NO. LFF 32139 LSF 32139 | | 20 |
| Surface Treatment Bore Clearance Tin Coated MRC: 0.100 mm MP: 12.00 mm | REFERENCE NO. 13101-87303 992-5113-1401 | REFERENCE NO. 992-5113-1410 | REFERENCE NO. 90043-84001/4 90043-84018/50 90043-84057 90043-84105 | REFERENCE NO. 992-5113-1101 992-5113-1171 | | | |
| DL 2765 cc DELTA 92 4 cyl. | \varnothing 92.00 -5.0 CD 50.5 TL 95.0 | 1 - 2.5 1 - 2.0 1 - 4.0 | \varnothing 26.000 TL 70.00 | | TL 178.0 OD 96.0 FT 3.0 +1.0 FD 101.0 | | |
| ENGINE COMPONENTS | TEIKIN NO. 32126 | TEIKIN NO. R 32126 | TEIKIN NO. P 32139 | TEIKIN NO. B 32102 | TEIKIN NO. LFF 32126 LSF 32126 | | 21 |
| Surface Treatment Bore Clearance Tin Coated MRC: 0.050 mm MP: 25.00 mm | REFERENCE NO. 13211-87312 13101-87312 13101-87314 13101-87315 | REFERENCE NO. 13011-87310/1/2 13011-87320/1 13015-87320/A 13015-87319 | REFERENCE NO. 90043-84001/4 90043-84018/50 90043-84057 90043-84105 | REFERENCE NO. 11461-87303 11461-87305 | | | |
| DL NEW-26 2765 cc TAFT GT OLD 4 cyl. | \varnothing 92.00 -5.0 CD 50.5 TL 95.0 | 1 - 2.5 1 - 2.0 1 - 4.0 | \varnothing 26.000 TL 70.00 | | TL 178.0 OD 96.0 FT 3.0 +1.0 FD 101.0 | | |
| ENGINE COMPONENTS | TEIKIN NO. 32128 32128A | TEIKIN NO. R 32126 | TEIKIN NO. P 32139 | TEIKIN NO. B 32128 | TEIKIN NO. LFF 32126 LSF 32126 | | 22 |
| Surface Treatment Bore Clearance Tin Coated MRC: 0.050 mm MP: 21.00 mm | REFERENCE NO. 13211-87319 13211-87320 13101-87319 13101-87320 | REFERENCE NO. 13011-87310/1/2 13011-87320/1 13015-87320/A 13015-87319 | REFERENCE NO. 90043-84052 | REFERENCE NO. 11461-87303 11461-87305 | | | |
| DL NEW-28 2765 cc TAFT GT NEW 4 cyl. | \varnothing 92.00 -5.1 CD 50.5 TL 95.0 | 1 - 2.5 1 - 2.0 1 - 4.0 | \varnothing 28.000 TL 74.80 | | TL 178.0 OD 96.0 FT 3.0 +1.0 FD 101.0 | | |
| ENGINE COMPONENTS | TEIKIN NO. 32127 | TEIKIN NO. R 32126 | TEIKIN NO. P 32127 | TEIKIN NO. B 32127 | TEIKIN NO. LFF 32126 LSF 32126 | | 23 |
| Surface Treatment Bore Clearance Tin Coated MRC: 0.050 mm MP: 21.00 mm | REFERENCE NO. 13101-87325 13101-87322 13105-87316/7/8 | REFERENCE NO. 13011-87310/1/2 13011-87320/1 13015-87320/A 13015-87319 | REFERENCE NO. 90043-84086 90043-84087 | REFERENCE NO. 11461-87303 11461-87305 | | | |

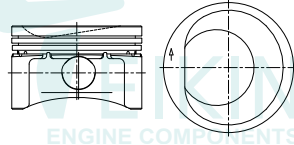
| ENGINE TYPE | PISTON | PISTON RING | PISTON PIN | PIN BUSHING | LINER | | LINER KIT SET |
|--|--------------------------------------|--------------------|--------------------------|-------------|---------|-----------|---------------|
| | | | | | FLANGED | NO FLANGE | |
| 103H, 105, 103 1953-54 1089 cc 4 cyl. | Ø 67.80 CD 46.0 TL 72.0 | 2 - 2.5 1 - 4.0 | Ø 22.000 TL 56.00 | | | | TEIKIN NO. |
| | TEIKIN NO. 34101 | | TEIKIN NO. P 34101 | | | | |
| Surface Treatment Bore Clearance Tin Coated MRC: 0.030 mm MP: 7.00 mm | REFERENCE NO. 4056519 | | | | | | |
| | | | | | | | 1 |
| 160 A3.000 204 AA. 11. 0 FIAT UNO 1100 FIRE 1990-ON 1108 cc 4 cyl. | Ø 70.00 CD 30.0 TL 54.0 | 2 - 1.5 1 - 3.0 | Ø 17.980 TL 52.40 | | | | TEIKIN NO. |
| | TEIKIN NO. 34119 | | TEIKIN NO. P 34119 | | | | |
| Surface Treatment Bore Clearance None MRC: 0.030 mm MP: 11.00 mm | REFERENCE NO. KS : 92 291 600 | | | | | | |
| | | | | | | | 2 |
| FIRE 16V SIENA PALIO PALIO WEEKEND 16V 1000 cc 4 cyl. | Ø 70.00 CD 33.1 TL 53.3 | 2 - 1.2 1 - 2.5 | Ø 17.973 TL 53.00 | | | | TEIKIN NO. |
| | TEIKIN NO. 34122 | | TEIKIN NO. P 34122 | | | | |
| Surface Treatment Bore Clearance None MRC: 0.030 mm MP: 9.00 mm | REFERENCE NO. MAHLE: S25410 | | | | | | |
| | | | | | | | 3 |
| FIRE 8V UNO PALIO SIENA 8V 1000 cc 4 cyl. | Ø 70.00 CD 33.1 TL 53.2 | 2 - 1.2 1 - 2.5 | Ø 17.973 TL 53.00 | | | | TEIKIN NO. |
| | TEIKIN NO. 34123 | | TEIKIN NO. P 34122 | | | | |
| Surface Treatment Bore Clearance None MRC: 0.030 mm MP: 9.00 mm | REFERENCE NO. MAHLE: S25400 | | | | | | |
| | | | | | | | 4 |

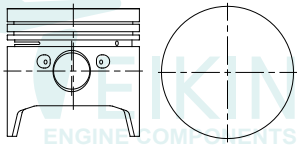
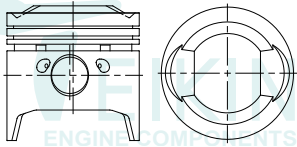
| ENGINE TYPE | PISTON | PISTON RING | PISTON PIN | PIN BUSHING | LINER | | LINER KIT SET |
|---|---|--------------------|--------------------------------|-------------|---------|-----------|---------------|
| | | | | | FLANGED | NO FLANGE | |
| FIRE FLEX 8V 1000 cc 4 cyl. PALIO STRADA 8V | \emptyset 70.00 +2.7 CD 33.1 TL 55.8 | 2 - 1.2 1 - 2.5 | \emptyset 17.973 TL 53.00 | | | | TEIKIN NO. |
|  | TEIKIN NO. 34124 | | TEIKIN NO. P 34122 | | | | |
| Surface Treatment Bore Clearance Moly Skirt MRC: 0.030 mm MP: 9.00 mm | REFERENCE NO. MAHLE: S25890 | | | | | | 5 |
| UNO 1100 1100 cc 4 cyl. | \emptyset 70.00 -1.6 CD 30.0 TL 54.0 | 2 - 1.5 1 - 3.0 | \emptyset 17.980 TL 52.40 | | | | TEIKIN NO. |
|  | TEIKIN NO. 34121 | | TEIKIN NO. P 34119 | | | | |
| Surface Treatment Bore Clearance None MRC: 0.030 mm MP: 11.00 mm | REFERENCE NO. | | | | | | 6 |
| FIRE 1.3L 16V 1300 cc 4 cyl. | \emptyset 70.80 -5.7 CD 28.0 TL 48.1 | 2 - 1.2 1 - 2.5 | \emptyset 17.973 TL 49.00 | | | | TEIKIN NO. |
|  | TEIKIN NO. 34126 | | TEIKIN NO. P 34125 | | | | |
| Surface Treatment Bore Clearance None MRC: 0.030 mm MP: 9.00 mm | REFERENCE NO. MAHLE: S25460 | | | | | | 7 |
| FIRE 1.3L 8V 1300 cc 4 cyl. | \emptyset 70.80 -2.2 CD 28.0 TL 48.2 | 2 - 1.2 1 - 2.5 | \emptyset 17.973 TL 49.00 | | | | TEIKIN NO. |
|  | TEIKIN NO. 34125 | | TEIKIN NO. P 34125 | | | | |
| Surface Treatment Bore Clearance None MRC: 0.030 mm MP: 9.00 mm | REFERENCE NO. MAHLE: S25450 | | | | | | 8 |

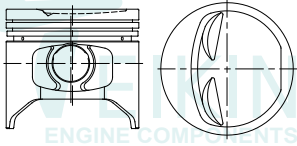
| ENGINE TYPE | PISTON | PISTON RING | PISTON PIN | PIN BUSHING | LINER | | LINER KIT SET |
|--|---|------------------------|---|-------------|---------|-----------|---------------|
| | | | | | FLANGED | NO FLANGE | |
| FIRE FLEX 1.3L 8V 1300 cc 4 cyl. PALIO DOBLO  | \varnothing 70.80 -1.0 CD 28.0 TL 48.1 | 2 - 1.2 1 - 2.5 | \varnothing 17.973 TL 49.00 | | | | TEIKIN NO. |
| | TEIKIN NO. 34127 | | TEIKIN NO. P 34125 | | | | |
| | REFERENCE NO. MAHLE: S25456 Surface Treatment Bore Clearance Moly Skirt MRC: 0.030 mm MP: 9.00 mm | | | | | | |
| 103G, 1100D 1221 cc 4 cyl. 1958-62  | \varnothing 71.85 CD 46.0 TL 72.0 | 2 - 2.0 1 - 4.0 | \varnothing 22.000 TL 60.00  | | | | TEIKIN NO. |
| | TEIKIN NO. 34102 | | TEIKIN NO. P 34102 | | | | |
| | REFERENCE NO. 3126553 Surface Treatment Bore Clearance Tin Coated MRC: 0.030 mm MP: 7.00 mm | | | | | | |
| 1300 1300 cc 4 cyl. 1961  | \varnothing 72.00 +8.5 CD 37.1 TL 88.6 | 2 - 2.0 1 - 4.0 | \varnothing 22.000 TL 60.00  | | | | TEIKIN NO. |
| | TEIKIN NO. 34109 | | TEIKIN NO. P 34102 | | | | |
| | REFERENCE NO. Surface Treatment Bore Clearance None MRC: 0.070 mm MP: 26.55 mm | | | | | | |
| FIRE FLEX 1.4L 8V 1400 cc 4 cyl. IDEA ELX ELX PALIO WEEKEND ELX ELX SIENA  | \varnothing 72.00 -6.3 CD 26.0 TL 46.1 | 2 - 1.2 1 - 2.0 | \varnothing 17.973 TL 49.00 | | | | TEIKIN NO. |
| | TEIKIN NO. 34128 | | TEIKIN NO. P 34125 | | | | |
| | REFERENCE NO. MAHLE: S25340 Surface Treatment Bore Clearance Moly Skirt MRC: 0.030 mm MP: 9.00 mm | | | | | | |

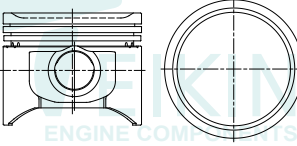
| ENGINE TYPE | PISTON | PISTON RING | PISTON PIN | PIN BUSHING | LINER | | LINER KIT SET |
|--|--|--------------------------------|----------------------------------|---|---------|-----------|---------------|
| | | | | | FLANGED | NO FLANGE | |
| 124S 4 cyl. | \varnothing 80.00 CD 37.8 TL 77.3 | 1 - 1.5 1 - 2.0 1 - 4.0 | \varnothing 21.980 TL 71.00 | | | | TEIKIN NO. |
|  | TEIKIN NO. 34113 | | TEIKIN NO. P 34113 | | | | |
| Surface Treatment Bore Clearance None MRC: 0.050 mm MP: 23.25 mm | REFERENCE NO. 11900474 | | | | | | 13 |
| 125, 125A BERLINA 1608 cc 4 cyl. | \varnothing 80.00 CD 37.8 TL 81.5 | 1 - 1.5 1 - 2.0 1 - 4.0 | \varnothing 22.000 TL 72.00 | | | | TEIKIN NO. |
|  | TEIKIN NO. 34103 | | TEIKIN NO. P 46199 | | | | |
| Surface Treatment Bore Clearance None MRC: 0.090 mm MP: 23.50 mm | REFERENCE NO. 4198046 | | | | | | 14 |
| 160 A1.00 FIAT UNO 1400 PACER, PACER SX 1990-ON 1372 cc 4 cyl. | \varnothing 80.50 CD 33.3 TL 73.1 | 1 - 1.5 1 - 1.8 1 - 3.0 | \varnothing 21.990 TL 58.00 |  | | | TEIKIN NO. |
|  | TEIKIN NO. 34120 | | TEIKIN NO. P 44273 | | | | |
| Surface Treatment Bore Clearance Tin Coated MRC: 0.030 mm MP: 20.50 mm | REFERENCE NO. KS : 92 292 600 | | | | | | 15 |
| SHAHEN 4 cyl. | \varnothing 80.50 CD 33.4 TL 65.2 | 1 - 1.5 1 - 1.75 1 - 3.0 | \varnothing 21.990 TL 58.00 |  | | | TEIKIN NO. |
|  | TEIKIN NO. 34130 | | TEIKIN NO. P 44273 | | | | |
| Surface Treatment Bore Clearance Chromated MRC: 0.030 mm MP: 13.50 mm | REFERENCE NO. | | | | | | 16 |

F

SUITABLE FOR



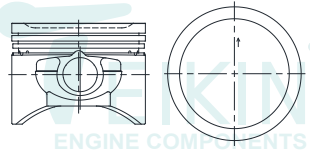

FIAT

GASOLINE

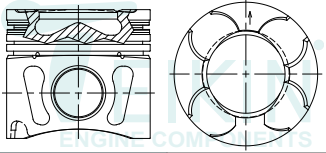

| ENGINE TYPE | PISTON | PISTON RING | PISTON PIN | PIN BUSHING | LINER | | LINER KIT SET |
|---|--|--------------------------------|---|-------------|---------|-----------|-------------------|
| | | | | | FLANGED | NO FLANGE | |
| TEMPRA 1600 TWO 4 cyl. | \varnothing 86.40 -3.0 CD 33.2 TL 65.2 | 1 - 1.5 1 - 1.75 1 - 3.0 | \varnothing 22.000 TL 64.00  | | | | TEIKIN NO. |
|  | TEIKIN NO. 34131 | | TEIKIN NO. P 43220 | | | | |
| Surface Treatment Tin Coated | Bore Clearance MRC: 0.030 mm MP: 15.00 mm | | | | | | |
| | REFERENCE NO. | | | | | | |

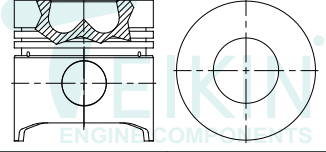
17

| ENGINE TYPE | PISTON | PISTON RING | PISTON PIN | PIN BUSHING | LINER | | LINER KIT SET |
|--|---|-------------------------------|---|------------------------------|---|-----------|----------------------------------|
| | | | | | FLANGED | NO FLANGE | |
| PALIO 1.3L JTD SWIFT DIESEL 4 cyl.  Surface Treatment Moly Skirt Bore Clearance MRC: 0.030 mm MP: 6.60 mm | \emptyset 69.60 -12.4 CD 40.4 TL 62.4 | 1 - 2.0 1 - 1.5 1 - 2.0 | \emptyset 23.000 TL 56.00  | | TL 137.0 OD 117.0 FT 4.9 FD 73.2 | | TEIKIN NO. LKSF 34129A |
| | TEIKIN NO. 34129A | TEIKIN NO. R 34129 | TEIKIN NO. P 34129 | TEIKIN NO. B 34129 | TEIKIN NO. LSF 34129 | | |
| | REFERENCE NO. 12111-83KAO | REFERENCE NO. | REFERENCE NO. | REFERENCE NO. | REFERENCE NO. | | |
| | | | | | | | |
| | | | | | | | |
| | | | | | | | 18 |
| TRACTOR 300, 350, 355 3456 cc SERIES : 8025, 8035 4 cyl. 8040, 8045, 8060, 8065  Surface Treatment None Bore Clearance MRC: 0.120 mm MP: 19.00 mm | \emptyset 100.00 -23.7 CD 59.7 TL 101.2 | 2 - 2.5 1 - 5.5 | \emptyset 32.000 TL 83.40  | | | | TEIKIN NO. |
| | TEIKIN NO. 34118 | | TEIKIN NO. P 46128 | | | | |
| | REFERENCE NO. 06.7239.OA | | | | | | |
| | | | | | | | |
| | | | | | | | |
| | | | | | | | 19 |

F

SUITABLE FOR

FORD

GASOLINE

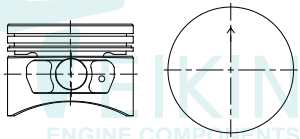
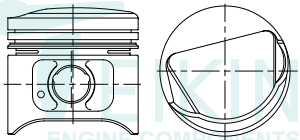
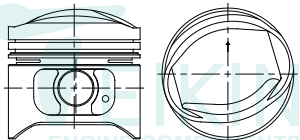
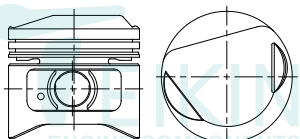

| ENGINE TYPE | PISTON | PISTON RING | PISTON PIN | PIN BUSHING | LINER | | LINER KIT SET |
|--|--------------------------------------|----------------------------------|-----------------------------|-------------|---------|-----------|---------------|
| | | | | | FLANGED | NO FLANGE | |
| JLB 1297 cc FORD ESCORT, ORION 1988-92 44KW 9:3:1 CR 4 cyl. | Ø 74.00 CD 29.4 TL 53.9 | 1 - 1.5 1 - 1.75 1 - 3.0 | Ø 18.034 TL 64.00 | | | | TEIKIN NO. |
|  | | TEIKIN NO. | TEIKIN NO. | | | | |
| Surface Treatment Bore Clearance Tin Coated MRC: 0.030 mm MP: 11.00 mm | | 35600 (35175) | P 35600 | | | | |
| | | REFERENCE NO. KS : 92 396 604 | | | | | 1 |
| CVH, FUA, F6B, FU 1392 cc F6D KAT, FUB, FUD FIESTA ESCORT 1985-92 ORION 1985-87 BANTAM 1400 1989-ON 4 cyl. | Ø 77.25 CD 39.3 TL 75.1 | 1 - 1.6 1 - 2.0 1 - 4.0 | Ø 20.630 TL 67.00 | | | | TEIKIN NO. |
|  | | TEIKIN NO. | TEIKIN NO. | | | | |
| Surface Treatment Bore Clearance Tin Coated MRC: 0.030 mm MP: 11.50 mm | | 35171 | P 35170 | | | | |
| | | REFERENCE NO. KS : 93 828 620 | | | | | 2 |
| CVH, JPA, JPC 1597 cc BANTAM 1600 ESCORT 1600 GLE, XR3, SPORT 1987-ON 4 cyl. | Ø 79.96 CD 39.4 TL 78.4 | 1 - 1.6 1 - 2.0 1 - 4.0 | Ø 20.630 TL 67.00 | | | | TEIKIN NO. |
|  | | TEIKIN NO. | TEIKIN NO. | | | | |
| Surface Treatment Bore Clearance Tin Coated MRC: 0.030 mm MP: 12.00 mm | | 35173 | P 35170 | | | | |
| | | REFERENCE NO. KS : 93 362 604 | | | | | 3 |
| CVH-LUC 1597 cc BANTAM 1600 ESCORT 1600, ORION GLE, XR3, SPORT 1987-ON 4 cyl. | Ø 79.96 CD 36.6 TL 74.9 | 1 - 1.6 1 - 2.0 1 - 4.0 | Ø 20.630 TL 67.00 | | | | TEIKIN NO. |
|  | | TEIKIN NO. | TEIKIN NO. | | | | |
| Surface Treatment Bore Clearance Tin Coated MRC: 0.030 mm MP: 12.50 mm | | 35170 | P 35170 | | | | |
| | | REFERENCE NO. KS : 90 204 600 | | | | | 4 |

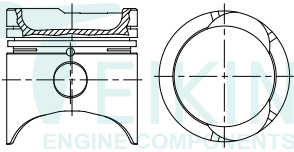
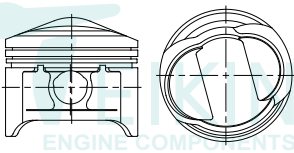
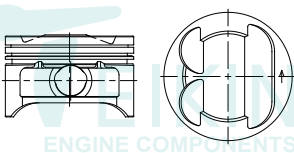
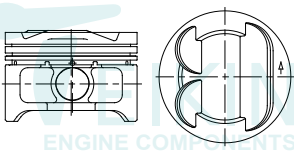
| ENGINE TYPE | PISTON | PISTON RING | PISTON PIN | PIN BUSHING | LINER | | LINER KIT SET |
|--|---|--------------------------------|---|-------------|---------|-----------|---------------|
| | | | | | FLANGED | NO FLANGE | |
| 751M, BG2C 1598 cc KENT 1968-86 1600 1 - TONNER, CAPRI 1600 ESCORT 1600, SPORT 1975-80 FIESTA XR2 1982-84 4 cyl. | Ø 80.99 -13.4 CD 44.1 TL 83.8 | 1 - 1.6 1 - 2.0 1 - 4.0 | Ø 20.640 TL 71.30  | | | | TEIKIN NO. |
|  | TEIKIN NO. | | TEIKIN NO. | | | | |
| Surface Treatment: Chromated Bore Clearance: MRC: 0.025 mm MP: 24.50 mm | | | | | | | |
| | REFERENCE NO. KS : 92 456 610 | | | | | | |
| | | | | | | | 5 |
| MOT. 1.9 Lt 1900 cc ESCORT LX SEDAN VAGONETA 1994-96 4 cyl. | Ø 82.00 +9.0 CD 34.3 TL 73.7 | 2 - 1.5 1 - 3.0 | Ø 20.630 TL 67.00 | | | | TEIKIN NO. |
|  | TEIKIN NO. | | TEIKIN NO. | | | | |
| Surface Treatment: Tin Coated Bore Clearance: MRC: 0.070 mm MP: 13.00 mm | | | | | | | |
| | REFERENCE NO. FIZ6108A | | | | | | |
| | | | | | | | 6 |
| 2.0 L 2000 cc DOHC 1998-2003 4 cyl. | Ø 84.80 +0.8 CD 29.4 TL 54.2 | 1 - 1.5 1 - 1.75 1 - 3.0 | Ø 20.000 TL 59.00 | | | | TEIKIN NO. |
|  | TEIKIN NO. | | TEIKIN NO. | | | | |
| Surface Treatment: Chromated Moly Skirt Bore Clearance: MRC: 0.020 mm MP: 11.00 mm | | | | | | | |
| | REFERENCE NO. XS7Z 6100 AA | | | | | | |
| | | | | | | | 7 |
| VIN 3 ZETEC 1998 cc CONTOUR, MISTIQUE 1995-97 F.I. DOHC 16V 4 cyl. | Ø 84.80 +1.25 CD 33.1 TL 58.4 | 1 - 1.5 1 - 1.75 1 - 3.0 | Ø 20.630 TL 63.00 | | | | TEIKIN NO. |
|  | TEIKIN NO. | | TEIKIN NO. | | | | |
| Surface Treatment: Tin Coated Bore Clearance: MRC: 0.020 mm MP: 10.00 mm | | | | | | | |
| | REFERENCE NO. F5RZ-6180A | | | | | | |
| | | | | | | | 8 |

SUITABLE FOR

FORD

GASOLINE

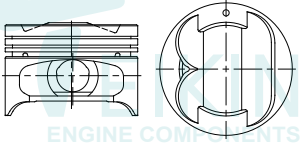
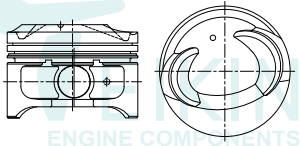
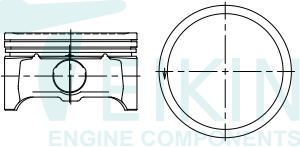
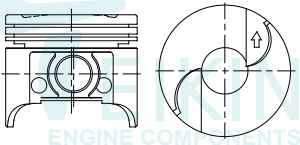

| ENGINE TYPE | PISTON | PISTON RING | PISTON PIN | PIN BUSHING | LINER | | LINER KIT SET |
|---|--|--------------------------------|--------------------------------|-------------|---------|-----------|---------------|
| | | | | | FLANGED | NO FLANGE | |
| ZETEC 1998 cc VIN 3, CONTOUR MISTIQUE DOHC 16V 1995-97 4 cyl. | \emptyset 84.80 +1.3 CD 32.6 TL 59.4 | 1 - 1.5 1 - 1.75 1 - 3.0 | \emptyset 20.630 TL 63.00 | | | | TEIKIN NO. |
|  | TEIKIN NO. 35177 | | TEIKIN NO. P 35177 | | | | |
| Surface Treatment Bore Clearance Tin Coated MRC: 0.030 mm MP: 12.00 mm | REFERENCE NO. | | | | | | 9 |
| CVH 2.0 4 cyl. | \emptyset 84.86 +4.8 CD 32.3 TL 60.6 | 2 - 1.5 1 - 3.0 | \emptyset 20.630 TL 63.00 | | | | TEIKIN NO. |
|  | TEIKIN NO. 35191 | | TEIKIN NO. P 35177 | | | | |
| Surface Treatment Bore Clearance None MRC: 0.030 mm MP: 10.00 mm | REFERENCE NO. | | | | | | 10 |
| AODA/B, CJBA/B, N4JB 1999 cc FOCUS 2.0 16V MONDEO 2.0I 16V VOLVO C30 2.0I 4 cyl. | \emptyset 87.50 -0.6 CD 28.5 TL 51.0 | 2 - 1.2 1 - 2.5 | \emptyset 21.000 TL 61.50 | | | | TEIKIN NO. |
|  | TEIKIN NO. 35181 | | TEIKIN NO. P 56104 | | | | |
| Surface Treatment Bore Clearance Moly Skirt MRC: 0.030 mm MP: 10.00 mm | REFERENCE NO. KS : 99 457 600 | | | | | | 11 |
| P-764 2000 cc 1983-88 AEROSTAR, RANGER 4 cyl. | \emptyset 89.32 -1.9 CD 40.2 TL 76.2 | 2 - 2.0 1 - 4.8 | \emptyset 23.170 TL 76.20 | | | | TEIKIN NO. |
|  | TEIKIN NO. 35169 | | TEIKIN NO. P 35169 | | | | |
| Surface Treatment Bore Clearance None MRC: 0.040 mm MP: 18.00 mm | REFERENCE NO. | | | | | | 12 |

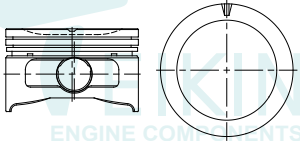
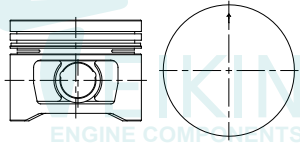
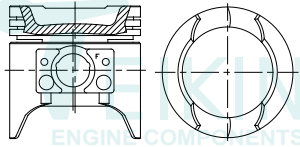
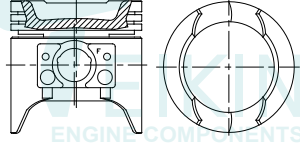
| ENGINE TYPE | PISTON | PISTON RING | PISTON PIN | PIN BUSHING | LINER | | LINER KIT SET |
|--|---|-------------------------------|--------------------------------|-------------|---------|-----------|---------------|
| | | | | | FLANGED | NO FLANGE | |
| 281 4600 cc SOHC V8 1991-98 8 cyl. | \emptyset 90.20 -3.9 CD 30.8 TL 56.3 | 2 - 1.5 1 - 3.0 | \emptyset 22.000 TL 62.00 | | | | TEIKIN NO. |
|  | TEIKIN NO. | | TEIKIN NO. | | | | |
| Surface Treatment: Moly Skirt Bore Clearance: MRC: 0.020 mm MP: 10.90 mm | 35174 | | P 43222 | | | | |
| | REFERENCE NO. | | | | | | |
| | | | | | | | 13 |
| KOLN 2V (T88) 1993 cc GRANA 2.0 GL, GLE SIERRA 2.0 GL, SAPPHIRE 2.0 CORTINA 200GT, GL, GLE ESCORT RS 2000 4 cyl. | \emptyset 90.82 CD 41.6 TL 69.6 | 1 - 1.6 1 - 2.0 1 - 4.0 | \emptyset 24.000 TL 68.50 | | | | TEIKIN NO. |
|  | TEIKIN NO. | | TEIKIN NO. | | | | |
| Surface Treatment: Tin Coated Bore Clearance: MRC: 0.030 mm MP: 8.50 mm | 35172 | | P 35172 | | | | |
| | REFERENCE NO. | | KS : 90 606 600 | | | | |
| | | | | | | | 14 |
| V4 2994 cc TRANSIT 130/160/190 CONSUL 3000GT 1969-75 GRANADA 3000GXL 1969-77 CAPRI 3000GT 1969-81, A 510 4 cyl. | \emptyset 93.65 -14.0 CD 46.0 TL 94.9 | 2 - 2.0 1 - 4.8 | \emptyset 23.810 TL 75.00 | | | | TEIKIN NO. |
|  | TEIKIN NO. | | TEIKIN NO. | | | | |
| Surface Treatment: None Bore Clearance: MRC: 0.020 mm MP: 27.95 mm | 35168-4 | | P 35168 | | | | |
| | REFERENCE NO. | | | | | | |
| | | | | | | | 15 |
| V6 2994 cc TRANSIT 130/160/190 CONSUL 3000GT 1969-75 GRANADA 3000GXL 1969-77 CAPRI 3000GT 1969-81, A 510 6 cyl. | \emptyset 93.65 -14.0 CD 46.0 TL 94.9 | 2 - 2.0 1 - 4.8 | \emptyset 23.810 TL 75.00 | | | | TEIKIN NO. |
|  | TEIKIN NO. | | TEIKIN NO. | | | | |
| Surface Treatment: None Bore Clearance: MRC: 0.020 mm MP: 27.95 mm | 35168 | | P 35168 | | | | |
| | REFERENCE NO. | | | | | | |
| | | | | | | | 16 |





F

SUITABLE FOR

FORD

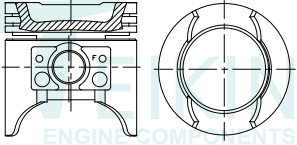

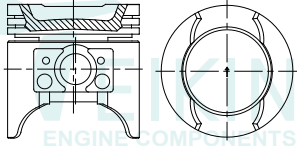

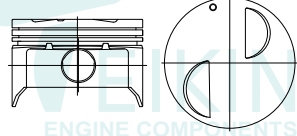
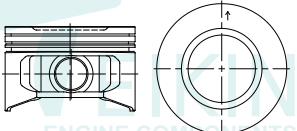



GASOLINE

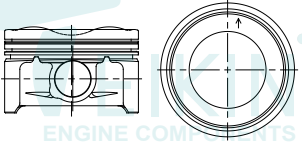

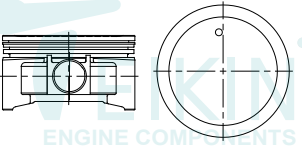
| ENGINE TYPE | PISTON | PISTON RING | PISTON PIN | LINER | | LINER KIT SET |
|---|--|--------------------|---|---------|-----------|---------------|
| | | | | FLANGED | NO FLANGE | |
| V6 ESSEX 2993 cc 6 cyl. RP40090 1984 SIERRA 3000 XR6 COURIER V6  | \emptyset 93.65 -13.9 CD 46.0 TL 94.8 | 2 - 2.0 1 - 4.8 | \emptyset 22.000 TL 69.50  | | | TEIKIN NO. |
| Surface Treatment Bore Clearance None MRC: 0.020 mm MP: 29.25 mm | TEIKIN NO. 35166 | | TEIKIN NO. P 46202 | | | |
| | REFERENCE NO. | | | | | |
| | | | | | | 17 |
| V6 ESSEX 2993 cc 6 cyl. RP40091 1984 SIERRA 3000 XR6 COURIER V6  | \emptyset 93.65 -11.7 CD 46.0 TL 95.0 | 2 - 2.0 1 - 4.8 | \emptyset 22.000 TL 69.50  | | | TEIKIN NO. |
| Surface Treatment Bore Clearance None MRC: 0.020 mm MP: 29.25 mm | TEIKIN NO. 35167 | | TEIKIN NO. P 46202 | | | |
| | REFERENCE NO. | | | | | |
| | | | | | | 18 |
| 140 2302 cc 4 cyl. 1995-1997  | \emptyset 96.00 -2.1 CD 33.9 TL 64.2 | 2 - 1.5 1 - 3.0 | \emptyset 23.170 TL 69.50 | | | TEIKIN NO. |
| Surface Treatment Bore Clearance None MRC: 0.030 mm MP: 16.50 mm | TEIKIN NO. 35183 | | TEIKIN NO. P 35183 | | | |
| | REFERENCE NO. F57Z6108AA | | | | | |
| | | | | | | 19 |
| 238 3887 cc 6 cyl. V6 3.9L 2004-2207  | \emptyset 96.80 -2.6 CD 35.3 TL 62.8 | 2 - 1.5 1 - 3.0 | \emptyset 23.000 TL 70.00 | | | TEIKIN NO. |
| Surface Treatment Bore Clearance Moly Skirt MRC: 0.030 mm MP: 12.00 mm | TEIKIN NO. 35182 | | TEIKIN NO. P 35182 | | | |
| | REFERENCE NO. | | | | | |
| | | | | | | 20 |

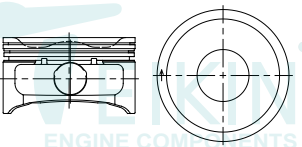
| ENGINE TYPE | PISTON | PISTON RING | PISTON PIN | PIN BUSHING | LINER | | LINER KIT SET |
|--|--|--|------------------------------------|----------------------|--|---------------|---------------|
| | | | | | FLANGED | NO FLANGE | |
| 2402 E 3537 cc TRANSIT 3.5 D 1971-77 A 0409, A 0709 1974-83 A 0609 1972-83 6 cyl. | \emptyset 93.65 -2.8 CD 61.7 TL 108.2 | 1 - 2.4 HK 1 - 2.4 1 - 4.8 | \emptyset 29.000 TL 75.00 | | | | TEIKIN NO. |
| | TEIKIN NO. | | TEIKIN NO. | | | | |
| | 35102 | | P 43171 | | | | |
| Surface Treatment Bore Clearance Tin Coated MRC: 0.110 mm MP: 25.00 mm | | | | | | | |
| | | | | | | | 21 |
| 4AB / BA / BB / CA / FA 2496 cc 4 cyl. | \emptyset 93.67 -18.0 CD 59.5 TL 94.0 | 1 - 2.5 FK 1 - 2.0 1 - 4.0 | \emptyset 29.000 TL 77.00 | | TL OD | 171.5 96.9 | TEIKIN NO. |
| | TEIKIN NO. | TEIKIN NO. | TEIKIN NO. | TEIKIN NO. | TEIKIN NO. | | |
| | 35601A | R 35601 | P 36101 | P 35601 | LSX 35601 | | LKX 35601A |
| Surface Treatment Bore Clearance Tin Coated MRC: 0.060 mm MP: 15.00 mm | REFERENCE NO. KS: 92 189 600 MAHLE: 014 82 00 | REFERENCE NO. KS: 800009940000 MAHLE: 014 82 NO | | REFERENCE NO. | REFERENCE NO. KS: 89 032 190 MAHLE: 014 WV 04 | | |
| | | | | | | | 22 |
| THAMES TRADER 1957-65 6 cyl. | \emptyset 100.00 -24.7 CD 71.0 TL 117.9 | 3 - 2.4 2 - 4.8 | \emptyset 34.925 TL 85.80 | | | | TEIKIN NO. |
| | TEIKIN NO. | | TEIKIN NO. | | | | |
| | 35101 | | P 35101 | | | | |
| Surface Treatment Bore Clearance Tin Coated MRC: 0.100 mm MP: 10.50 mm | | | | | | | |
| | | | | | | | 23 |

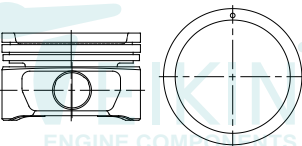
F

| ENGINE TYPE | PISTON | PISTON RING | PISTON PIN | PIN BUSHING | LINER | | LINER KIT SET |
|--|--|-------------------------------|---|-------------|---------|-----------|---|
| | | | | | FLANGED | NO FLANGE | |
| B207R 1998 cc 4 cyl.  Surface Treatment Bore Clearance Tin Coated MRC: 0.030 mm MP: 5.80 mm | \emptyset 86.00 +1.7 CD 31.7 TL 55.3 | 1 - 1.2 1 - 1.5 1 - 2.5 | \emptyset 23.000 TL 62.00  | | | | TEIKIN NO. 5 |
| | TEIKIN NO. 58110 | TEIKIN NO. P 55103 | | | | | |
| | REFERENCE NO. 12791210 12590988 | | | | | | |
| | | | | | | | |
| L61 2198 cc 4 cyl. 2.2L 134 DOHC 16V 2000-05  Surface Treatment Bore Clearance Moly Skirt MRC: 0.030 mm MP: 7.75 mm | \emptyset 86.00 -0.7 CD 26.5 TL 48.4 | 1 - 1.2 1 - 1.5 1 - 2.5 | \emptyset 20.000 TL 58.00  | | | | TEIKIN NO. 6 |
| | TEIKIN NO. 58102 | TEIKIN NO. P 52112 | | | | | |
| | REFERENCE NO. | | | | | | |
| | | | | | | | |
| ASTRA 2384 cc 4 cyl. ASTRA 2004-2008 16V DOHC  Surface Treatment Bore Clearance Tin Coated MRC: 0.030 mm Anodized Crown MP: 10.00 mm | \emptyset 87.50 -6.4 CD 27.3 TL 50.3 | 1 - 1.2 1 - 1.5 1 - 2.5 | \emptyset 21.000 TL 63.50  | | | | TEIKIN NO. 7 |
| | TEIKIN NO. 58103 | TEIKIN NO. P 32120 | | | | | |
| | REFERENCE NO. 93399844 | | | | | | |
| | | | | | | | |
| 191 3136 cc 6 cyl. V6 1994-1996  Surface Treatment Bore Clearance Moly Skirt MRC: 0.030 mm MP: 5.00 mm | \emptyset 89.00 -7.1 CD 37.4 TL 57.0 | 2 - 1.5 1 - 4.0 | \emptyset 23.000 TL 62.00  | | | | TEIKIN NO. 8 |
| | TEIKIN NO. 58108 | TEIKIN NO. P 55103 | | | | | |
| | REFERENCE NO. 24505806 | | | | | | |
| | | | | | | | |







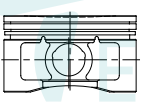

G

SUITABLE FOR

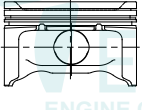

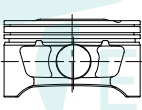

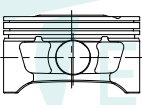

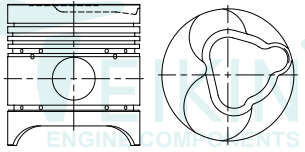

GENERAL MOTOR

GASOLINE

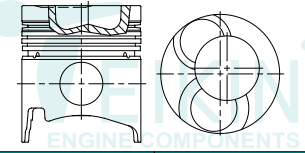

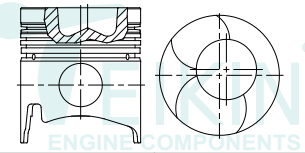

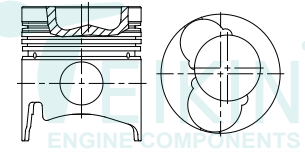





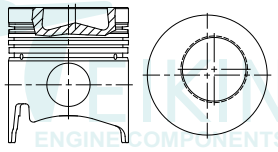

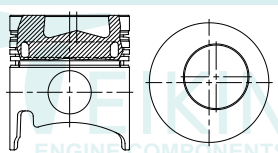

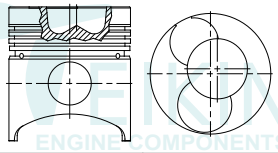

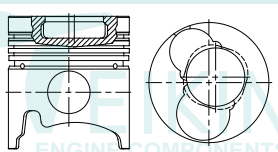

| ENGINE TYPE | PISTON | PISTON RING | PISTON PIN | PIN BUSHING | LINER | | LINER KIT SET |
|--|--|--|-------------------------------|---|---------|-----------|-------------------|
| | | | | | FLANGED | NO FLANGE | |
| MOT. 146 Cavalier 16V 1996-97 | 2400 cc 4 cyl. | \emptyset 90.00 -0.9 CD 29.8 TL 51.7 | 1 - 1.2 1 - 1.5 1 - 3.0 | \emptyset 22.000 TL 60.00  | | | TEIKIN NO. |
|   | TEIKIN NO. 58101 | TEIKIN NO. P 34102 | | | | | |
| Surface Treatment Tin Coated | Bore Clearance MRC: 0.030 mm MP: 6.00 mm | REFERENCE NO. 24545963 | | | | | |
| | | | | | | | 9 |
| 213/LX9 V6 3.5L 2004-2007 | 3498 cc 6 cyl. | \emptyset 94.00 -5.9 CD 32.3 TL 59.8 | 1 - 1.2 1 - 1.5 1 - 2.5 | \emptyset 24.000 TL 61.00 | | | TEIKIN NO. |
|   | TEIKIN NO. 58109 | TEIKIN NO. P 46300 | | | | | |
| Surface Treatment Moly Skirt | Bore Clearance MRC: 0.030 mm MP: 12.00 mm | REFERENCE NO. 12577586 | | | | | |
| | | | | | | | 10 |
| LLV | 2921 cc 4 cyl. | \emptyset 95.50 +1.0 CD 28.7 TL 54.5 | 1 - 1.2 1 - 1.5 1 - 2.5 | \emptyset 23.500 TL 65.50  | | | TEIKIN NO. |
|   | TEIKIN NO. 58111 | TEIKIN NO. P 58111 | | | | | |
| Surface Treatment Chromated Moly Skirt | Bore Clearance MRC: 0.030 mm MP: 11.00 mm | REFERENCE NO. 89018218 | | | | | |
| | | | | | | | 11 |
| LLR | 3653 cc 5 cyl. | \emptyset 95.50 +1.0 CD 28.7 TL 54.4 | 1 - 1.2 1 - 1.5 1 - 2.5 | \emptyset 23.500 TL 65.50  | | | TEIKIN NO. |
|   | TEIKIN NO. 58111-5 | TEIKIN NO. P 58111 | | | | | |
| Surface Treatment Chromated Moly Skirt | Bore Clearance MRC: 0.030 mm MP: 11.00 mm | REFERENCE NO. 89018218 | | | | | |
| | | | | | | | 12 |

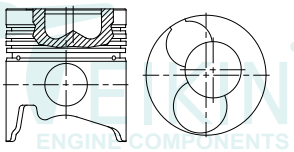
| ENGINE TYPE | PISTON | PISTON RING | PISTON PIN | PIN BUSHING | LINER | | LINER KIT SET |
|---|---|---|--------------------------|--------------------------|--|-----------|--|
| | | | | | FLANGED | NO FLANGE | |
| W04D LATE 409 cc 4 cyl. Surface Treatment: Tin Coated Bore Clearance: MRC: 0.040 mm, MP: 23.00 mm | Ø 104.00 -18.4 CD 60.2 TL 106.2 | 1 - 2.5 1 - 2.0 1 - 5.0 | Ø 35.000 TL 85.00 | | TL 201.0 OD 107.0 FT 8.0 +0.9 FD 112.0 | | TEIKIN NO. LKFF 36658 LKFF 36658A |
| | TEIKIN NO. | TEIKIN NO. | TEIKIN NO. | TEIKIN NO. | TEIKIN NO. | | |
| | 36658 36658A | R 36653 | P 39166 | B 36653 | LFF 36658 | | |
| | REFERENCE NO. | REFERENCE NO. | REFERENCE NO. | REFERENCE NO. | REFERENCE NO. | | |
| | 13216-2220 | 13011-1973 13011-2540 13019-1150 | | 13272-1280 13272-1281 | 11467-1761/71 11467-1781/91 11461-78020/30 11461-78040/50 | | 5 |
| W06D 5759 cc 6 cyl. Surface Treatment: Tin Coated Bore Clearance: MRC: 0.080 mm, MP: 14.20 mm | Ø 104.00 -18.5 CD 62.6 TL 108.7 | 1 - 2.5 1 - 2.0 1 - 5.0 | Ø 35.000 TL 85.00 | | TL 201.0 OD 107.0 FT 8.0 +0.9 FD 112.0 | | TEIKIN NO. LKFF 36651A |
| | TEIKIN NO. | TEIKIN NO. | TEIKIN NO. | TEIKIN NO. | TEIKIN NO. | | |
| | 36651A | R 36651 | P 39166 | B 36651 | LFF 36651 | | |
| | REFERENCE NO. | REFERENCE NO. | REFERENCE NO. | REFERENCE NO. | REFERENCE NO. | | |
| | 13216-1470 13216-1470D 13216-1470E | 13011-1983 13011-2420 13011-2440 | | 13272-1280 13272-1281 | 11467-1761 11467-1771 11467-1781 11467-1791 | | 6 |
| W06DT 5759 cc 6 cyl. Surface Treatment: Tin Coated Bore Clearance: MRC: 0.070 mm, MP: 24.00 mm | Ø 104.00 -19.4 CD 62.7 TL 108.7 | 1 - 2.8 FK 1 - 2.5 1 - 5.0 | Ø 37.000 TL 85.00 | | TL 201.0 OD 107.0 FT 8.0 +0.9 FD 112.0 | | TEIKIN NO. LKFF 36661A |
| | TEIKIN NO. | TEIKIN NO. | TEIKIN NO. | TEIKIN NO. | TEIKIN NO. | | |
| | 36661A | R 36661 | P 36127 | B 36656 | LFF 36651 | | |
| | REFERENCE NO. | REFERENCE NO. | REFERENCE NO. | REFERENCE NO. | REFERENCE NO. | | |
| | 13211-1982 | 13011-2610A 13011-2950A 13011-2680A | | | 11467-1761 11467-1771 11467-1781 11467-1791 | | 7 |
| W06E 6014 cc 6 cyl. Surface Treatment: Tin Coated Bore Clearance: MRC: 0.070 mm, MP: 25.00 mm | Ø 104.00 -19.1 CD 60.2 TL 106.2 | 1 - 2.5 1 - 2.0 1 - 5.0 | Ø 35.000 TL 85.00 | | TL 201.0 OD 107.0 FT 8.0 +0.9 FD 112.0 | | TEIKIN NO. LKFF 36656A |
| | TEIKIN NO. | TEIKIN NO. | TEIKIN NO. | TEIKIN NO. | TEIKIN NO. | | |
| | 36656A | R 36651 | P 39166 | B 36656 | LFF 36651 | | |
| | REFERENCE NO. | REFERENCE NO. | REFERENCE NO. | REFERENCE NO. | REFERENCE NO. | | |
| | 13211-2070 13216-1720 13216-1720B | 13011-1983 13011-2420 13011-2440 | | | 11467-1761 11467-1771 11467-1781 11467-1791 | | 8 |

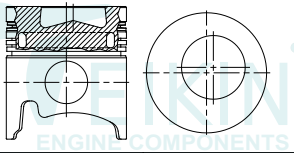
| ENGINE TYPE | PISTON | PISTON RING | PISTON PIN | PIN BUSHING | LINER | | | LINER KIT SET |
|---|---|--|---|--|--|-----------|----------------------------------|---------------|
| | | | | | FLANGED | NO FLANGE | | |
| EH-100 5871 cc KR-105 6 cyl. 1972  | \emptyset 105.00 -6.6 CD 59.2 TL 112.0 | 3 - 2.5 2 - 4.0 | \emptyset 34.000 TL 88.50  | | TL 204.0 OD 110.0 FT 8.0 +0.5 FD 115.0 | | TEIKIN NO. LKFF 36111 | |
| | TEIKIN NO. 36111 | TEIKIN NO. R 36111 | TEIKIN NO. P 46242 | TEIKIN NO. B 36111 | TEIKIN NO. LFF 36111 | | | |
| | REFERENCE NO. 2382-1961-00 13216-1010 13211-1170 | REFERENCE NO. 13011-1150 13011-1410 | | REFERENCE NO. 13271-1030 | REFERENCE NO. 11467-1030 11467-1040 | | | |
| | Surface Treatment Bore Clearance Tin Coated MRC: 0.110 mm MP: 21.00 mm | | | | | | | 9 |
| H06BT 6224 cc 6 cyl.  | \emptyset 105.80 -24.6 CD 69.5 TL 121.5 | 1 - 2.8 HK 2 - 2.5 1 - 5.0 | \emptyset 39.000 TL 87.50  | | TL 204.0 OD 110.0 FT 8.0 +0.7 FD 118.0 | | TEIKIN NO. LKFF 36652A | |
| | TEIKIN NO. 36652A | TEIKIN NO. R 36652 | TEIKIN NO. P 36652 | TEIKIN NO. B 36113 | TEIKIN NO. LFF 36652 | | | |
| | REFERENCE NO. 13216-1591 | REFERENCE NO. 13011-2880A | | REFERENCE NO. 13272-1220 13272-1270 | REFERENCE NO. 11467-1921 11467-1931 11467-1941 11467-1951 | | | |
| | Surface Treatment Bore Clearance Tin Coated MRC: 0.110 mm MP: 20.00 mm | | | | | | | 10 |
| H06CTB 6485 cc 6 cyl.  | \emptyset 108.00 -25.6 CD 69.5 TL 121.5 | 1 - 3.0 FK 2 - 2.5 1 - 5.0 | \emptyset 39.000 TL 90.00  | | TL 204.0 OD 113.0 FT 8.0 +1.0 FD 118.0 | | TEIKIN NO. LKFF 36136A | |
| | TEIKIN NO. 36136A | TEIKIN NO. R 36135 | TEIKIN NO. P 36113 | TEIKIN NO. B 36113 | TEIKIN NO. LFF 36135 | | | |
| | REFERENCE NO. 13216-1540 13216-1540B | REFERENCE NO. 13011-1961 | | REFERENCE NO. 13272-1220 13272-1270 | REFERENCE NO. 11467-1591 11467-1601 11467-1611 11467-1621 | | | |
| | Surface Treatment Bore Clearance Tin Coated MRC: 0.110 mm MP: 28.50 mm | | | | | | | 11 |
| H06CTE 6485cc 6 cyl.  | \emptyset 108.00 -21.2 CD 69.5 TL 121.5 | 1 - 3.0 FK 2 - 2.5 1 - 5.0 | \emptyset 39.000 TL 90.00  | | TL 204.0 OD 113.0 FT 8.0 +1.0 FD 118.0 | | TEIKIN NO. LKFF 36135A | |
| | TEIKIN NO. 36135A | TEIKIN NO. R 36135 | TEIKIN NO. P 36113 | TEIKIN NO. B 36113 | TEIKIN NO. LFF 36135 | | | |
| | REFERENCE NO. 13216-1750 | REFERENCE NO. 13011-1961 | | REFERENCE NO. 13272-1220 13272-1270 | REFERENCE NO. 11467-1591 11467-1601 11467-1611 11467-1621 | | | |
| | Surface Treatment Bore Clearance Tin Coated MRC: 0.110 mm MP: 28.50 mm | | | | | | | 12 |

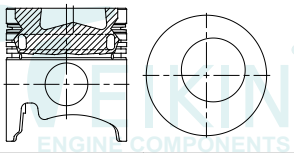

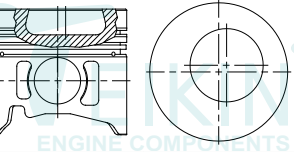



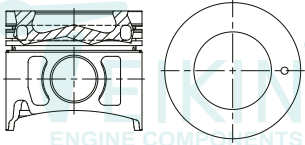

H

| ENGINE TYPE | PISTON | PISTON RING | PISTON PIN | PIN BUSHING | LINER | | LINER KIT SET | |
|---|--|--|---|-------------------|---|--|--|--|
| | | | | | FLANGED | NO FLANGE | | |
| H06CTI/CTL-II 6485 cc 6 cyl.  Surface Treatment Tin Coated Bore Clearance MRC: 0.110 mm MP: 28.50 mm | \varnothing 108.00 -20.25 CD 69.5 TL 121.5 | 1 - 3.0 FK 2 - 2.5 1 - 4.0 | \varnothing 39.000 TL 90.00  | | | | TEIKIN NO. 13 | |
| | TEIKIN NO. | | TEIKIN NO. | | | | | |
| | TEIKIN NO. | 36133A | | P 36113 | | | | |
| | REFERENCE NO. | 13216-2600 | | | | | | |
| H06CTI/CTL-III 6 cyl.  Surface Treatment Tin Coated Bore Clearance MRC: 0.100 mm MP: 28.50 mm | \varnothing 108.00 -20.3 CD 69.5 TL 121.5 | 1 - 2.8 FK 2 - 2.0 1 - 4.0 | \varnothing 39.000 TL 90.00  | | | | TEIKIN NO. 14 | |
| | TEIKIN NO. | | TEIKIN NO. | | | | | |
| | TEIKIN NO. | 36137AG | | P 36113 | | | | |
| | REFERENCE NO. | 13216-2840 | | | | | | |
| EH-700 6443 cc 6 cyl.  Surface Treatment Tin Coated Bore Clearance MRC: 0.100 mm MP: 28.00 mm | \varnothing 110.00 -24.5 CD 69.3 TL 121.3 | 1 - 3.0 2 - 2.5 1 - 5.0 | \varnothing 39.000 TL 90.00  | | TL 204.0 OD 113.0 FT 8.0 +0.8 FD 118.0 | | TEIKIN NO. LKFF 36113 LKFF 36113A 15 | |
| | TEIKIN NO. | TEIKIN NO. | TEIKIN NO. | TEIKIN NO. | TEIKIN NO. | | | |
| | TEIKIN NO. | 36113 36113A | R 36113 | P 36113 | B 36113 | LFF 36113 | | |
| | REFERENCE NO. | 13216-1180 13211-1471 13216-1181 | 13011-1610/B 13011-1620/A 13011-2070A 13011-2090 | | 13272-1220 13272-1270 | 11467-1200 11467-1210 11467-1220 11467-1230 | | |
| | Surface Treatment | Bore Clearance | | | | | | |
| | Tin Coated | MRC: 0.100 mm MP: 28.00 mm | | | | | | |
| H07C NEW 6728 cc SUPER RANGER 6 cyl.  Surface Treatment Tin Coated Bore Clearance MRC: 0.100 mm MP: 28.00 mm | \varnothing 110.00 -20.0 CD 69.5 TL 121.5 | 1 - 3.0 2 - 2.5 1 - 5.0 | \varnothing 39.000 TL 90.00  | | TL 204.0 OD 113.0 FT 8.0 +0.8 FD 118.0 | | TEIKIN NO. LKFF 36124 LKFF 36124A 16 | |
| | TEIKIN NO. | TEIKIN NO. | TEIKIN NO. | TEIKIN NO. | TEIKIN NO. | | | |
| | TEIKIN NO. | 36124 36124A | R 36113 | P 36113 | B 36113 | LFF 36113 | | |
| | REFERENCE NO. | 13216-1771 13216-2300 | 13011-1610/B 13011-1620/A 13011-2070A 13011-2090 | | 13272-1220 13272-1270 | 11467-1200 11467-1210 11467-1220 11467-1230 | | |
| | Surface Treatment | Bore Clearance | | | | | | |
| | Tin Coated | MRC: 0.100 mm MP: 28.00 mm | | | | | | |

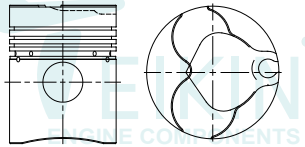

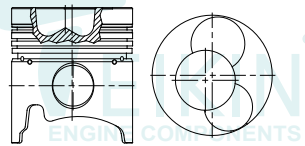

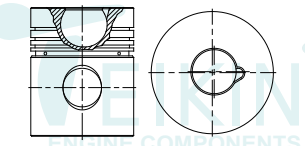
| ENGINE TYPE | PISTON | PISTON RING | PISTON PIN | PIN BUSHING | LINER | | LINER KIT SET |
|---|---|---|---|--|---|-----------|--|
| | | | | | FLANGED | NO FLANGE | |
| H07C OLD 6728 cc RANGER 6 cyl.  | \emptyset 110.00 -27.6 CD 69.5 TL 121.5 | 1 - 3.0 2 - 2.5 1 - 5.0 | \emptyset 39.000 TL 90.00  | | TL 204.0 OD 113.0 FT 8.0 +0.8 FD 118.0 | | TEIKIN NO. LKFF 36125 LKFF 36125A |
| | TEIKIN NO. 36125 36125A | TEIKIN NO. R 36113 | TEIKIN NO. P 36113 | TEIKIN NO. B 36113 | TEIKIN NO. LFF 36113 | | |
| | REFERENCE NO. 13216-1851 13216-2290 | REFERENCE NO. 13011-1610/B 13011-1620/A 13011-2070A 13011-2090 | REFERENCE NO. 13272-1220 13272-1270 | REFERENCE NO. 11467-1200 11467-1210 11467-1220 11467-1230 | | | |
| | Surface Treatment Bore Clearance Tin Coated MRC: 0.100 mm MP: 28.00 mm | | | | | | 17 |
| H07C-T 6728 cc 6 cyl.  | \emptyset 110.00 -19.5 CD 69.5 TL 121.5 | 1 - 2.8 FK 2 - 2.0 1 - 4.0 | \emptyset 39.000 TL 90.00  | | TL 204.0 OD 113.0 FT 8.0 +0.8 FD 118.0 | | TEIKIN NO. LKFF 36129AG |
| | TEIKIN NO. 36129AG | TEIKIN NO. R 36129 | TEIKIN NO. P 36113 | TEIKIN NO. B 36113 | TEIKIN NO. LFF 36113 | | |
| | REFERENCE NO. 13216-2740 | REFERENCE NO. 13011-3510 13011-3510A | REFERENCE NO. 13272-1220 13272-1270 | REFERENCE NO. 11467-1200 11467-1210 11467-1220 11467-1230 | | | |
| | Surface Treatment Bore Clearance Tin Coated MRC: 0.110 mm MP: 28.50 mm | | | | | | 18 |
| H07C-T-II 6728 cc 6 cyl.  | \emptyset 110.00 -19.5 CD 69.4 TL 121.4 | 1 - 2.8 FK 1 - 2.0 1 - 2.5 1 - 4.0 | \emptyset 39.000 TL 90.00  | | TL 204.0 OD 113.0 FT 8.0 +0.8 FD 118.0 | | TEIKIN NO. LKFF 36655AG |
| | TEIKIN NO. 36655AG | TEIKIN NO. R 36655 | TEIKIN NO. P 36113 | TEIKIN NO. B 36113 | TEIKIN NO. LFF 36113 | | |
| | REFERENCE NO. 13216-2062 | REFERENCE NO. 13011-2672 13011-2672A | REFERENCE NO. 13272-1220 13272-1270 | REFERENCE NO. 11467-1200 11467-1210 11467-1220 11467-1230 | | | |
| | Surface Treatment Bore Clearance Tin Coated MRC: 0.110 mm MP: 28.50 mm | | | | | | 19 |
| H07D 7412 cc 6 cyl.  | \emptyset 110.00 -20.5 CD 57.0 TL 100.0 | 1 - 3.0 1 - 2.0 1 - 4.0 | \emptyset 37.000 TL 85.00  | | TL 204.0 OD 113.0 FT 8.0 +0.8 FD 118.0 | | TEIKIN NO. LKFF 36127 LKFF 36127A |
| | TEIKIN NO. 36127 36127A | TEIKIN NO. R 36127 | TEIKIN NO. P 36127 | TEIKIN NO. B 36127 | TEIKIN NO. LFF 36113 | | |
| | REFERENCE NO. 13216-2260 | REFERENCE NO. 13011-2650 13011-2651/A 13011-2660 | REFERENCE NO. 11467-1200 11467-1210 11467-1220 11467-1230 | | | | |
| | Surface Treatment Bore Clearance Tin Coated MRC: 0.050 mm MP: 20.60 mm | | | | | | 20 |

H

| ENGINE TYPE | PISTON | PISTON RING | PISTON PIN | PIN BUSHING | LINER | | LINER KIT SET | |
|--|---|---|--------------------------------------|---|---|-----------|--|-----------|
| | | | | | FLANGED | NO FLANGE | | |
| J05C 4 cyl. Surface Treatment: Tin Coated Bore Clearance: MRC: 0.070 mm, MP: 21.00 mm | \varnothing 114.00 -19.6 CD 57.1 TL 100.0 | 1 - 3.0 1 - 2.0 1 - 4.0 | \varnothing 37.000 TL 84.50 | | TL 204.0 OD 117.0 FT 8.0 +0.8 FD 122.0 | | TEIKIN NO. LKFF 36657A | |
| | TEIKIN NO. 36657A | TEIKIN NO. R 36657 | TEIKIN NO. P 36657 | TEIKIN NO. B 36657 | TEIKIN NO. LFF 36657 | | | |
| | REFERENCE NO. 13216-2631 | REFERENCE NO. 13011-3391B | | REFERENCE NO. 13271-1420 13272-1300B 13272-1381 | REFERENCE NO. 11467-2601 11467-2611 11467-2621 11461-78070 | | | 21 |
| | | | | | | | | |
| J05C-T 5307 cc 4 cyl. Surface Treatment: Tin Coated Bore Clearance: MRC: 0.110 mm, MP: 20.00 mm | \varnothing 114.00 -18.4 CD 57.0 TL 100.0 | 1 - 2.5 1 - 2.0 1 - 4.0 | \varnothing 37.000 TL 85.00 | | TL 204.0 OD 117.0 FT 8.0 +0.8 FD 122.0 | | TEIKIN NO. LKFF 36659AG-4 | |
| | TEIKIN NO. 36659AG-4 | TEIKIN NO. R 36659-4 | TEIKIN NO. P 36659 | TEIKIN NO. B 36657 | TEIKIN NO. LFF 36657 | | | |
| | REFERENCE NO. 13306-1080 | REFERENCE NO. 13011-3880A 13011-3940A 13019-1010B | | REFERENCE NO. 13271-1420 13272-1300B 13272-1381 | REFERENCE NO. 11467-2601 11467-2611 11467-2621 | | | 22 |
| | | | | | | | | |
| J07C-T 6634 cc 5 cyl. Surface Treatment: Tin Coated Bore Clearance: MRC: 0.110 mm, MP: 20.00 mm | \varnothing 114.00 -18.4 CD 57.0 TL 100.0 | 1 - 2.5 1 - 2.0 1 - 4.0 | \varnothing 37.000 TL 85.00 | | TL 204.0 OD 117.0 FT 8.0 +0.8 FD 122.0 | | TEIKIN NO. LKFF 36659AG-5 | |
| | TEIKIN NO. 36659AG-5 | TEIKIN NO. R 36659-5 | TEIKIN NO. P 36659 | TEIKIN NO. B 36657 | TEIKIN NO. LFF 36657 | | | |
| | REFERENCE NO. 13306-1080 | REFERENCE NO. 13011-3660A 13011-3900A | | REFERENCE NO. 13271-1420 13272-1300B 13272-1381 | REFERENCE NO. 11467-2601 11467-2611 11467-2621 | | | 23 |
| | | | | | | | | |
| J08C 7961 cc 6 cyl. Surface Treatment: Tin Coated Bore Clearance: MRC: 0.070 mm, MP: 21.00 mm | \varnothing 114.00 -19.6 CD 57.1 TL 100.0 | 1 - 3.0 1 - 2.0 1 - 4.0 | \varnothing 37.000 TL 84.50 | | TL 204.0 OD 117.0 FT 8.0 +0.8 FD 122.0 | | TEIKIN NO. LKFF 36657-6 LKFF 36657A-6 | |
| | TEIKIN NO. 36657-6 36657A-6 | TEIKIN NO. R 36657-6 | TEIKIN NO. P 36657 | TEIKIN NO. B 36657 | TEIKIN NO. LFF 36657 | | | |
| | REFERENCE NO. 13216-2631 | REFERENCE NO. 13011-2960A 13011-2961A 13011-2962 13011-2962A | | REFERENCE NO. 13271-1420 13272-1300B 13272-1381 | REFERENCE NO. 11467-2601 11467-2611 11467-2621 | | | 24 |
| | | | | | | | | |

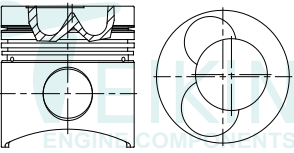
| ENGINE TYPE | PISTON | PISTON RING | PISTON PIN | PIN BUSHING | LINER | | LINER KIT SET |
|---|---|--|--|--|--|-----------|--|
| | | | | | FLANGED | NO FLANGE | |
| J08C-T 7961 cc 6 cyl.  | \emptyset 114.00 -18.4 CD 57.0 TL 100.0 | 1 - 2.5 1 - 2.0 1 - 4.0 | \emptyset 37.000 TL 85.00  | | TL 204.0 OD 117.0 FT 8.0 +0.8 FD 122.0 | | TEIKIN NO. LKFF 36659AG |
| | TEIKIN NO. | TEIKIN NO. | TEIKIN NO. | TEIKIN NO. | TEIKIN NO. | | |
| | 36659AG | R 36659 | P 36659 | B 36657 | LFF 36657 | | |
| | REFERENCE NO. | REFERENCE NO. | REFERENCE NO. | REFERENCE NO. | REFERENCE NO. | | |
| Surface Treatment Bore Clearance Tin Coated MRC: 0.110 mm MP: 20.00 mm | 13306-1080 | 13011-3570/A 13011-3820/A 13011-3870/A | 13271-1420 13272-1300B 13272-1381 | 11467-2601 11467-2611 11467-2621 | | | 25 |
| EB300 9838 cc 6 cyl.  | \emptyset 120.00 -6.0 CD 86.4 TL 155.4 | 3 - 3.5 1 - 6.0 | \emptyset 45.000 TL 100.00  | | TL 288.0 OD 136.0 FT 11.0 +1.0 FD 143.0 | | TEIKIN NO. LKFF 36601 |
| | TEIKIN NO. | TEIKIN NO. | TEIKIN NO. | TEIKIN NO. | TEIKIN NO. | | |
| | 36601 (36130) | R 36601 | P 36601 | B 36601 | LFF 36601 | | |
| | REFERENCE NO. | REFERENCE NO. | REFERENCE NO. | REFERENCE NO. | REFERENCE NO. | | |
| Surface Treatment Bore Clearance Tin Coated MRC: 0.190 mm MP: 27.00 mm | 13216-1110 13216-1110A 2334-1961-00 | 13011-1330 13011-1720 13011-1730/A | 13272-1100 | 11467-1180 11467-1520 2334-1963-00 | | | 26 |
| EM 100 9419 cc 6 cyl.  | \emptyset 124.00 -28.3 CD 80.4 TL 139.4 | 1 - 2.8 FK 1 - 2.5 1 - 3.0 1 - 5.0 | \emptyset 42.000 TL 98.00  | | TL 236.0 OD 129.1 FT 8.0 +1.2 FD 134.0 | | TEIKIN NO. LKFF 36128 LKFF 36128A |
| | TEIKIN NO. | TEIKIN NO. | TEIKIN NO. | TEIKIN NO. | TEIKIN NO. | | |
| | 36128 36128A | R 36128 | P 36128 | B 36128 | LFF 36128 | | |
| | REFERENCE NO. | REFERENCE NO. | REFERENCE NO. | REFERENCE NO. | REFERENCE NO. | | |
| Surface Treatment Bore Clearance Tin Coated MRC: 0.130 mm MP: 32.00 mm | 13216-1370 | 13011-1921 13011-1931 13011-3530 | 13272-1250 | 11467-1661 11467-1671 | | | 27 |
| ED-100 11581 cc 6 cyl.  | \emptyset 128.00 -49.0 CD 99.2 TL 160.0 | 3 - 3.5 1 - 6.0 | \emptyset 48.000 TL 106.00  | | | | |
| | TEIKIN NO. | | TEIKIN NO. | | | | |
| | 36112 | | P 36112 | | | | |
| | REFERENCE NO. | | | | | | |
| Surface Treatment Bore Clearance Tin Coated MRC: 0.160 mm MP: 18.40 mm | 2-400-1901-02 13216-1170 13211-1530 | | | | | | 28 |

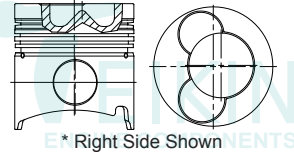
H

| ENGINE TYPE | PISTON | PISTON RING | PISTON PIN | PIN BUSHING | LINER | | LINER KIT SET |
|---|---|--|--|----------------------|--|-----------|----------------------------------|
| | | | | | FLANGED | NO FLANGE | |
| EK100 13267 cc 6 cyl.  Surface Treatment Tin Coated Bore Clearance MRC: 0.170 mm MP: 10.00 mm | \varnothing 137.00 -31.7 CD 90.2 TL 145.4 | 1 - 3.3 FK 2 - 3.5 1 - 6.0 | \varnothing 50.000 TL 110.00  | | TL 267.0 OD 153.0 FT 12.0 +0.8 FD 164.0 | | TEIKIN NO. LKFF 36650A |
| | TEIKIN NO. | TEIKIN NO. | TEIKIN NO. | TEIKIN NO. | TEIKIN NO. | | |
| | 36650A | R 36650 | P 36650 | B 36650 | LFF 36650 | | |
| | REFERENCE NO. | REFERENCE NO. | | REFERENCE NO. | REFERENCE NO. | | |
| | 13216-1220A 13216-1222/24 13211-1900 13216-1530 | 13011-1010/1 13011-1021 13011-1021/B 13011-2210 | | 13272-1010 | 11467-1080 11467-1910 11467-1960 11467-1920 | | |
| EF750 16745 cc 8 cyl.  * Right Side Shown Surface Treatment Tin Coated Bore Clearance MRC: 0.170 mm MP: 10.00 mm | \varnothing 137.00 -30.3 CD 90.3 TL 144.3 | 1 - 3.5 FK 2 - 3.5 1 - 6.0 | \varnothing 50.000 TL 110.00  | | TL 248.0 OD 153.0 FT 12.0 +0.8 FD 165.0 | | TEIKIN NO. LKFF 36654A |
| | TEIKIN NO. | TEIKIN NO. | TEIKIN NO. | TEIKIN NO. | TEIKIN NO. | | |
| | 36654A | R 36654 | P 36650 | B 36654 | LFF 36654 | | |
| | REFERENCE NO. | REFERENCE NO. | | REFERENCE NO. | REFERENCE NO. | | |
| | 13226-1170(R) 13216-1860(L) | 13011-1111/2 13011-1121/B 13011-1122 13011-2180 | | 13272-1240 | 11467-1091 11467-1900 | | |

29

30

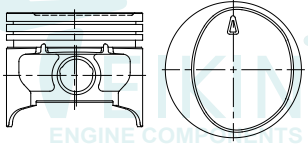
| ENGINE TYPE | PISTON | PISTON RING | PISTON PIN | PIN BUSHING | LINER | | LINER KIT SET |
|---|---|---------------------|------------------------------|-------------|---------|-----------|---------------|
| | | | | | FLANGED | NO FLANGE | |
| 202 202ci BLUE-BLACK 202ci RED | 3297 cc 6 cyl. Ø 92.08 -1.7 CD 42.4 TL 77.1 | 2 - 2.0 1 - 4.75 | Ø 22.000 TL 66.00 | | | | |
|  | | | | | | | |
| | TEIKIN NO. 37116 | | TEIKIN NO. P 39104 | | | | |
| | REFERENCE NO. 6KRY3302 | | | | | | |
| Surface Treatment None | Bore Clearance MRC: 0.030 mm MP: 20.00 mm | | | | | | |
| | | | | | | | 1 |

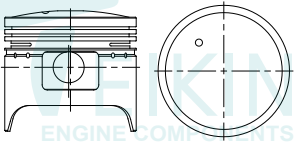
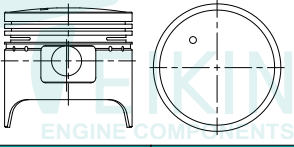
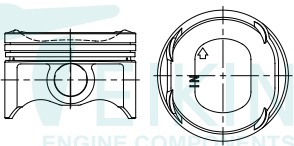
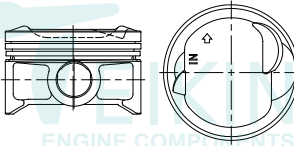
| ENGINE TYPE | PISTON | PISTON RING | PISTON PIN | PIN BUSHING | LINER | | LINER KIT SET |
|---|--|-----------------------------------|----------------------------------|-------------|---------|-----------|---------------|
| | | | | | FLANGED | NO FLANGE | |
| EJ EB3 NEW CIVIC 1300 1978-83 4 cyl. | \varnothing 72.00 +3.5 CD 27.5 TL 66.0 | 2 - 1.5 1 - 4.0 | \varnothing 17.000 TL 62.00 | | | | TEIKIN NO. |
|  | TEIKIN NO. | | TEIKIN NO. | | | | |
| Surface Treatment: None Bore Clearance: MRC: 0.020 mm, MP: 17.00 mm | | | | | | | |
| | 38147 | | P 38109 | | | | |
| | REFERENCE NO. | | | | | | |
| | | | | | | | 1 |
| EN EB3 1238 cc 4 cyl. | \varnothing 72.00 +2.5 CD 27.5 TL 65.0 | 2 - 1.5 1 - 4.0 | \varnothing 17.000 TL 62.00 | | | | TEIKIN NO. |
|  | TEIKIN NO. | | TEIKIN NO. | | | | |
| Surface Treatment: None Bore Clearance: MRC: 0.020 mm, MP: 19.00 mm | | | | | | | |
| | 38109 | | P 38109 | | | | |
| | REFERENCE NO. | | | | | | |
| | 13101-PA1-010 | | | | | | |
| | | | | | | | 2 |
| JAZZ RS FIT 2008 - ON 1.5L 1500 cc 4 cyl. | \varnothing 73.00 +1.6 CD 26.2 TL 49.3 | 2 - 1.0 1 - 2.0 | \varnothing 18.000 TL 53.00 | | | | TEIKIN NO. |
|  | TEIKIN NO. | | TEIKIN NO. | | | | |
| Surface Treatment: Moly Skirt Bore Clearance: MRC: 0.030 mm, MP: 10.00 mm | | | | | | | |
| | 38183 | | P 46332 | | | | |
| | REFERENCE NO. | | | | | | |
| | 13010-RB1-000 | | | | | | |
| | | | | | | | 3 |
| L13A4 1339 cc 4 cyl. | \varnothing 73.00 +2.7 CD 26.2 TL 44.7 | 1 - 1.0 1 - 1.2 1 - 2.0 | \varnothing 18.000 TL 54.00 | | | | TEIKIN NO. |
|  | TEIKIN NO. | | TEIKIN NO. | | | | |
| Surface Treatment: Moly Skirt Bore Clearance: MRC: 0.030 mm, MP: 7.00 mm | | | | | | | |
| | 38657 | | P 38657 | | | | |
| | REFERENCE NO. | | | | | | |
| | 13101-PWH-M00 | | | | | | |
| | | | | | | | 4 |

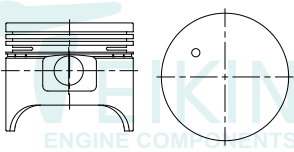
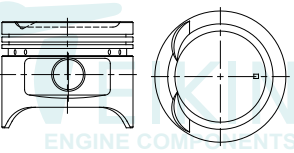
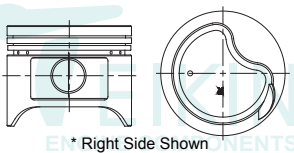
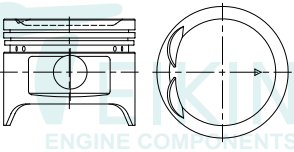
| ENGINE TYPE | PISTON | PISTON RING | PISTON PIN | PIN BUSHING | LINER | | LINER KIT SET |
|---|---|------------------------|----------------------|-------------|---------|-----------|------------------------------|
| | | | | | FLANGED | NO FLANGE | |
| EM1 1488 cc 4 cyl.  TEIKIN ENGINE COMPONENTS Surface Treatment Tin Coated Bore Clearance MRC: 0.030 mm MP: 19.00 mm | Ø 74.00 CD 27.7 TL 62.7 | 2 - 1.5 1 - 4.0 | Ø 17.000 TL 62.00 | | | | TEIKIN NO. 9 |
| | TEIKIN NO. 38650 | TEIKIN NO. P 38109 | | | | | |
| | REFERENCE NO. 13101-PA6-000 13101-PA6-305 | | | | | | |
| | | | | | | | |
| EV 1342 cc 4 cyl.  TEIKIN ENGINE COMPONENTS Surface Treatment Tin Coated Bore Clearance MRC: 0.030 mm MP: 14.00 mm | Ø 74.00 CD 29.9 TL 59.9 | 2 - 1.5 1 - 4.0 | Ø 19.000 TL 56.00 | | | | TEIKIN NO. 10 |
| | TEIKIN NO. 38600 (38164) | TEIKIN NO. P 38145 | | | | | |
| | REFERENCE NO. 13101-PE7-000 | | | | | | |
| | | | | | | | |
| EW 1488 cc 4 cyl. CIVIC, CRX DX CARB, SOHC 16 V 1984-87  TEIKIN ENGINE COMPONENTS * Right Side Shown Surface Treatment Tin Coated Bore Clearance MRC: 0.030 mm MP: 13.50 mm | Ø 74.00 CD 29.7 TL 59.7 | 2 - 1.2 1 - 2.8 | Ø 19.000 TL 56.00 | | | | TEIKIN NO. 11 |
| | TEIKIN NO. 38603 (38160) | TEIKIN NO. P 38145 | | | | | |
| | REFERENCE NO. 13101-PE1-000(R) 13105-PE1-000(L) | | | | | | |
| | | | | | | | |
| EW-II 1488 cc 4 cyl.  TEIKIN ENGINE COMPONENTS Surface Treatment Tin Coated Bore Clearance MRC: 0.030 mm MP: 14.00 mm | Ø 74.00 CD 29.7 TL 59.6 | 2 - 1.5 1 - 4.0 | Ø 19.000 TL 56.00 | | | | TEIKIN NO. 12 |
| | TEIKIN NO. 38605 (38163) | TEIKIN NO. P 38145 | | | | | |
| | REFERENCE NO. 13101-PE4-000 | | | | | | |
| | | | | | | | |

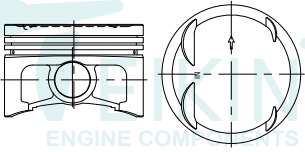
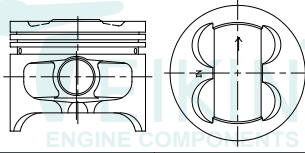
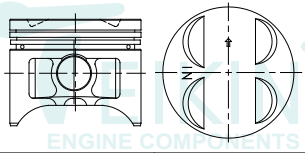
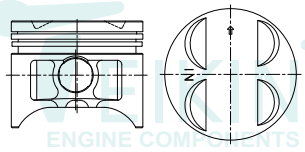
| ENGINE TYPE | PISTON | PISTON RING | PISTON PIN | PIN BUSHING | LINER | | LINER KIT SET |
|---|---|-------------------------------|--------------------------------|-------------|---------|-----------|---------------|
| | | | | | FLANGED | NO FLANGE | |
| D13 1343 cc CIVIC DX 88-95 4 cyl. | \emptyset 75.00 -1.0 CD 31.0 TL 51.0 | 1 - 1.2 1 - 1.5 1 - 2.8 | \emptyset 19.000 TL 55.00 | | | | TEIKIN NO. |
|  | TEIKIN NO. 38666 | | TEIKIN NO. P 44695 | | | | |
| Surface Treatment Bore Clearance Tin Coated MRC: 0.030 mm MP: 6.00 mm | REFERENCE NO. 13010-P3R-T00 | | | | | | 13 |
| D15 1493 cc 4 cyl. | \emptyset 75.00 +1.0 CD 30.8 TL 61.8 | 1 - 1.2 1 - 1.5 1 - 4.0 | \emptyset 19.000 TL 56.00 | | | | TEIKIN NO. |
|  | TEIKIN NO. 38656 | | TEIKIN NO. P 38145 | | | | |
| Surface Treatment Bore Clearance Tin Coated MRC: 0.030 mm MP: 14.00 mm | REFERENCE NO. 13010-PM3-K00 | | | | | | 14 |
| D15B2/D15B1 1493 cc CIVIC CRX 4 cyl. F.I., SOHC 4, 16 V 1988-91 | \emptyset 75.00 CD 30.9 TL 60.9 | 1 - 1.2 1 - 1.5 1 - 2.8 | \emptyset 19.000 TL 56.00 | | | | TEIKIN NO. |
|  | TEIKIN NO. 38145 | | TEIKIN NO. P 38145 | | | | |
| Surface Treatment Bore Clearance Tin Coated MRC: 0.020 mm MP: 13.50 mm | REFERENCE NO. 13101-PM3-000 13101-PM3-010 13101-PM3-020 | | | | | | 15 |
| D15B-II 1500 cc 4 cyl. | \emptyset 75.00 -4.3 CD 30.9 TL 60.9 | 1 - 1.2 1 - 1.5 1 - 4.0 | \emptyset 19.000 TL 56.00 | | | | TEIKIN NO. |
|  | TEIKIN NO. 38187 | | TEIKIN NO. P 38145 | | | | |
| Surface Treatment Bore Clearance None MRC: 0.030 mm MP: 13.50 mm | REFERENCE NO. 13101-PM3-P02 13101-PM3-P01 13101-P02-101 13101-PM3-P00 | | | | | | 16 |

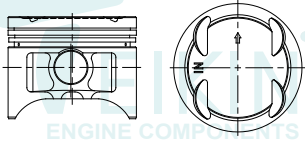
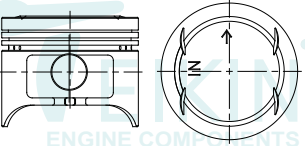
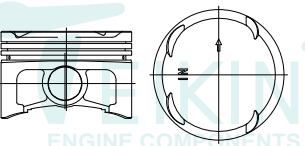
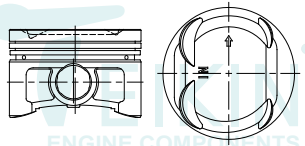

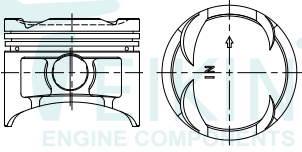
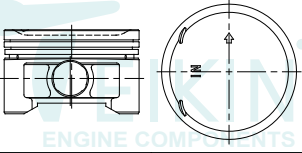
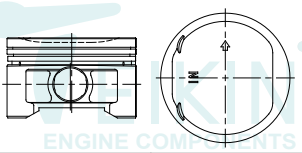
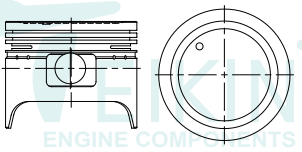

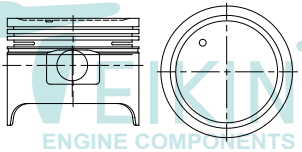
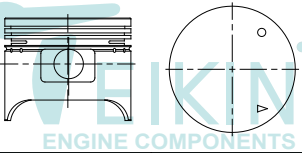
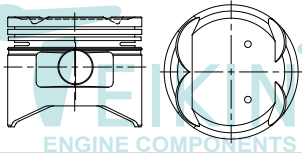
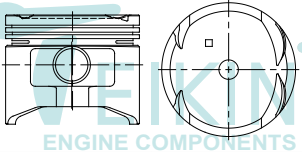
| ENGINE TYPE | PISTON | PISTON RING | PISTON PIN | PIN BUSHING | LINER | | LINER KIT SET |
|--|--|-------------------------------|--------------------------------|-------------|---------|-----------|---------------|
| | | | | | FLANGED | NO FLANGE | |
| D16A6-II 4 cyl. | \emptyset 75.00 -1.0 CD 29.5 TL 59.6 | 1 - 1.2 1 - 1.5 1 - 2.8 | \emptyset 19.000 TL 56.00 | | | | TEIKIN NO. |
|  | TEIKIN NO. 38173 | | TEIKIN NO. P 38145 | | | | |
| Surface Treatment None Bore Clearance MRC: 0.020 mm MP: 13.50 mm | REFERENCE NO. 13101-PM6-000 13101-PM6-010 | | | | | | 21 |
| D16A-II 1590 cc 4 cyl. | \emptyset 75.00 +0.7 CD 30.0 TL 60.7 | 1 - 1.2 1 - 1.5 1 - 2.8 | \emptyset 19.000 TL 56.00 | | | | TEIKIN NO. |
|  | TEIKIN NO. 38665 | | TEIKIN NO. P 38145 | | | | |
| Surface Treatment Tin Coated Bore Clearance MRC: 0.030 mm MP: 11.00 mm | REFERENCE NO. 13101-PG6-000 13101-PR3-003 13102-PG6-000 13012-PG6-000 | | | | | | 22 |
| D16Y7 1590 cc 4 cyl. | \emptyset 75.00 -3.5 CD 30.0 TL 50.0 | 1 - 1.0 1 - 1.2 1 - 2.8 | \emptyset 19.000 TL 56.00 | | | | TEIKIN NO. |
|  | TEIKIN NO. 38181 | | TEIKIN NO. P 38145 | | | | |
| Surface Treatment Tin Coated Bore Clearance MRC: 0.030 mm MP: 7.00 mm | REFERENCE NO. 13010-P2E-000 13101-P2E-000 | | | | | | 23 |
| D16Y8 1590 cc 4 cyl. CIVIC 1995-99 DEL SOL 1996-97 F.I., SOHC | \emptyset 75.00 -2.2 CD 29.3 TL 49.4 | 1 - 1.0 1 - 1.2 1 - 2.8 | \emptyset 19.000 TL 56.00 | | | | TEIKIN NO. |
|  | TEIKIN NO. 38153 | | TEIKIN NO. P 38145 | | | | |
| Surface Treatment None Bore Clearance MRC: 0.020 mm MP: 7.00 mm | REFERENCE NO. 13010-P2P-000 13101-P2P-000 | | | | | | 24 |

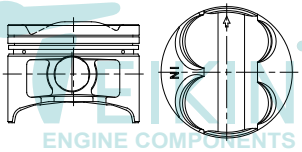
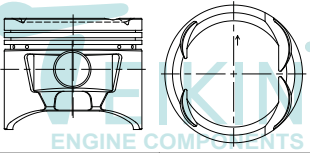
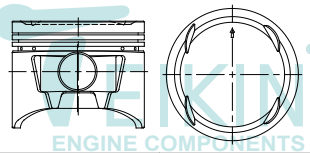
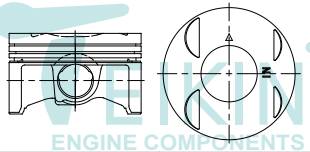
| ENGINE TYPE | PISTON | PISTON RING | PISTON PIN | PIN BUSHING | LINER | | LINER KIT SET |
|--|---|-------------------------------|-----------------------|-------------|---------|-----------|---------------|
| | | | | | FLANGED | NO FLANGE | |
| D16Z6 1590 cc CIVIC VTEC F.I., SOHC, 16 V 1992-95 4 cyl. | Ø 75.00 -3.5 CD 30.1 TL 60.0 | 1 - 1.2 1 - 1.5 1 - 2.8 | Ø 19.000 TL 56.00 | | | | TEIKIN NO. |
|  | TEIKIN NO. 38149 | | TEIKIN NO. P 38145 | | | | |
| Surface Treatment Tin Coated Bore Clearance MRC: 0.020 mm MP: 15.30 mm | REFERENCE NO. 13010-P28-A01 13101-P28-A01 | | | | | | 25 |
| D17A1 1700 cc SOHC 16 V 2001-02 4 cyl. | Ø 75.00 -3.0 CD 27.0 TL 46.6 | 1 - 1.0 1 - 1.2 1 - 2.0 | Ø 19.000 TL 56.00 | | | | TEIKIN NO. |
|  | TEIKIN NO. 38170 | | TEIKIN NO. P 38145 | | | | |
| Surface Treatment None Bore Clearance MRC: 0.030 mm MP: 7.30 mm | REFERENCE NO. 13010-PLM-A00 13101-PLM-A00 | | | | | | 26 |
| D17A2 1700 cc SOHC 16 V 2001-02 4 cyl. | Ø 75.00 -2.65 CD 26.9 TL 46.4 | 1 - 1.0 1 - 1.2 1 - 2.0 | Ø 19.000 TL 56.00 | | | | TEIKIN NO. |
|  | TEIKIN NO. 38169 | | TEIKIN NO. P 38145 | | | | |
| Surface Treatment Tin Coated Bore Clearance MRC: 0.030 mm MP: 7.30 mm | REFERENCE NO. 13010-PLR-A00 | | | | | | 27 |
| EK-1 1750 cc ED - 3 4 cyl. | Ø 77.00 -1.15 CD 27.6 TL 62.6 | 2 - 1.5 1 - 4.0 | Ø 18.000 TL 70.00 | | | | TEIKIN NO. |
|  | TEIKIN NO. 38114 | | TEIKIN NO. P 38114 | | | | |
| Surface Treatment None Bore Clearance MRC: 0.030 mm MP: 18.50 mm | REFERENCE NO. 13101-689-000 | | | | | | 28 |



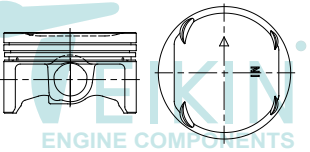

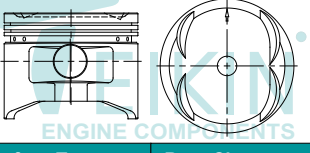

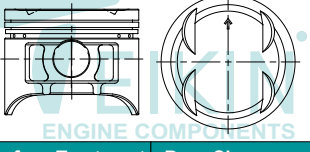
| ENGINE TYPE | PISTON | PISTON RING | PISTON PIN | PIN BUSHING | LINER | | LINER KIT SET |
|--|--|--------------------|--------------------------------|-------------|---------|-----------|---------------|
| | | | | | FLANGED | NO FLANGE | |
| EK-1-III 4 cyl. | \emptyset 77.00 -1.1 CD 27.5 TL 62.5 | 2 - 1.5 1 - 4.0 | \emptyset 18.000 TL 70.00 | | | | TEIKIN NO. |
|  | TEIKIN NO. 38179 | | TEIKIN NO. P 38114 | | | | |
| Surface Treatment Tin Coated Bore Clearance MRC: 0.030 mm MP: 18.50 mm | REFERENCE NO. 13101-689-010 | | | | | | 29 |
| EP 1601 cc 4 cyl. | \emptyset 77.00 CD 28.0 TL 62.5 | 2 - 1.5 1 - 4.0 | \emptyset 18.000 TL 62.00 | | | | TEIKIN NO. |
|  | TEIKIN NO. 38652 | | TEIKIN NO. P 38652 | | | | |
| Surface Treatment Tin Coated Bore Clearance MRC: 0.030 mm MP: 17.00 mm | REFERENCE NO. 13101-PC1-000 13101-PC1-010 13101-PC3-600 | | | | | | 30 |
| ES 1829 cc 4 cyl. | \emptyset 80.00 -1.3 CD 29.8 TL 65.3 | 2 - 1.5 1 - 4.0 | \emptyset 20.000 TL 62.00 | | | | TEIKIN NO. |
|  | TEIKIN NO. 38602 (38165) | | TEIKIN NO. P 38129 | | | | |
| Surface Treatment Tin Coated Bore Clearance MRC: 0.030 mm MP: 17.00 mm | REFERENCE NO. 13101-PD3-000 | | | | | | 31 |
| ES1 1829 cc 4 cyl. | \emptyset 80.00 -2.0 CD 29.8 TL 65.3 | 2 - 1.5 1 - 4.0 | \emptyset 20.000 TL 62.00 | | | | TEIKIN NO. |
|  | TEIKIN NO. 38655 | | TEIKIN NO. P 38129 | | | | |
| Surface Treatment Tin Coated Bore Clearance MRC: 0.030 mm MP: 9.00 mm | REFERENCE NO. 13101-PC7-000 13101-PC7-730 13101-PC7-731 | | | | | | 32 |

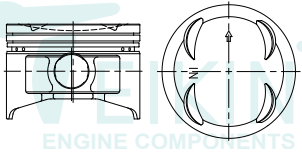
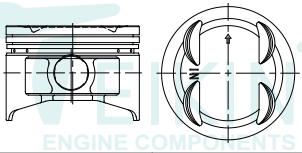
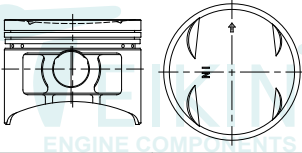
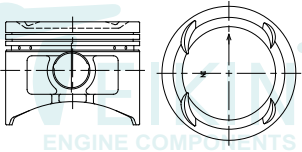

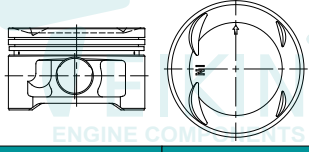

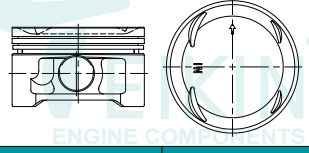

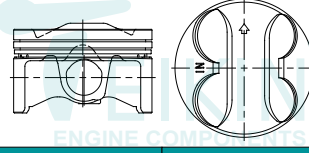
| ENGINE TYPE | PISTON | PISTON RING | PISTON PIN | PIN BUSHING | LINER | | LINER KIT SET |
|---|--|-------------------------------|--------------------------------|-------------|---------|-----------|---------------|
| | | | | | FLANGED | NO FLANGE | |
| B18C1 1797 cc INTEGRA TYPE R MODE F.I., DOHC 16 V 4 cyl. | \emptyset 81.00 +1.8 CD 30.4 TL 62.2 | 1 - 1.0 1 - 1.2 1 - 2.8 | \emptyset 21.000 TL 56.00 | | | | TEIKIN NO. |
|  | TEIKIN NO. 38151 | TEIKIN NO. P 38151 | | | | | |
| Surface Treatment Bore Clearance Moly Skirt MRC: 0.020 mm MP: 14.70 mm | REFERENCE NO. 13010-P73-A00 | | | | | | |
| | | | | | | | |
| B20A3 1958 cc 4 cyl. | \emptyset 81.00 -2.0 CD 29.8 TL 65.2 | 1 - 1.2 1 - 1.5 1 - 2.8 | \emptyset 20.000 TL 62.00 | | | | TEIKIN NO. |
|  | TEIKIN NO. 38664 | TEIKIN NO. P 38129 | | | | | |
| Surface Treatment Bore Clearance Tin Coated MRC: 0.030 mm MP: 16.00 mm | REFERENCE NO. 13101-PK1-000/010 | | | | | | |
| | | | | | | | |
| B20A5 1958 cc 4 cyl. | \emptyset 81.00 -2.0 CD 30.9 TL 65.4 | 1 - 1.2 1 - 1.5 1 - 2.8 | \emptyset 22.000 TL 57.00 | | | | TEIKIN NO. |
|  | TEIKIN NO. 38660 | TEIKIN NO. P 38660 | | | | | |
| Surface Treatment Bore Clearance Tin Coated MRC: 0.030 mm MP: 16.50 mm | REFERENCE NO. 13101-PK2-660 13101-PK2-662 | | | | | | |
| | | | | | | | |
| R18A1/A2 1799 cc CIVIC - FR - V SOHC 16V 2006 - 2009 4 cyl. | \emptyset 81.00 -2.2 CD 28.9 TL 49.4 | 2 - 1.2 1 - 2.0 | \emptyset 19.960 TL 46.00 | | | | TEIKIN NO. |
|  | TEIKIN NO. 38659 | TEIKIN NO. P 38186 | | | | | |
| Surface Treatment Bore Clearance Moly Skirt MRC: 0.030 mm MP: 8.00 mm | REFERENCE NO. 13010-RNA-A00 13020-RNA-A00 | | | | | | |
| | | | | | | | |

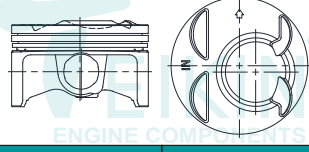
H

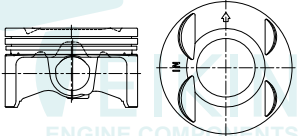
| ENGINE TYPE | PISTON | PISTON RING | PISTON PIN | PIN BUSHING | LINER | | LINER KIT SET |
|--|--|------------------------------|---|-------------|---------|-----------|------------------------------|
| | | | | | FLANGED | NO FLANGE | |
| R20A 2000 cc 4 cyl.  Surface Treatment Moly Skirt Bore Clearance MRC: 0.030 mm MP: 8.00 mm | \varnothing 81.00 -2.1 CD 28.8 TL 49.3 | 2 - 1.2 1 - 2.0 | \varnothing 19.960 TL 46.00  | | | | TEIKIN NO. 41 |
| | TEIKIN NO. 38186 | TEIKIN NO. P 38186 | | | | | |
| | REFERENCE NO. 13010-RNA-Y00 | | | | | | |
| | | | | | | | |
| A20A BS-II 1955 cc 4 cyl.  Surface Treatment Tin Coated Bore Clearance MRC: 0.030 mm MP: 16.85 mm | \varnothing 82.70 -2.4 CD 29.8 TL 65.3 | 2 - 1.5 1 - 4.0 | \varnothing 20.000 TL 62.00 | | | | TEIKIN NO. 42 |
| | TEIKIN NO. 38654 | TEIKIN NO. P 38129 | | | | | |
| | REFERENCE NO. 13101-PH4-000 | | | | | | |
| | | | | | | | |
| BS / A20A1 1955 cc 4 cyl. BT / A20A3 1986-89 ACCORD 1986-89  Surface Treatment Tin Coated Bore Clearance MRC: 0.030 mm MP: 16.85 mm | \varnothing 82.70 -2.4 CD 29.8 TL 65.3 | 2 - 1.5 1 - 4.0 | \varnothing 20.000 TL 62.00 | | | | TEIKIN NO. 43 |
| | TEIKIN NO. 38129 | TEIKIN NO. P 38129 | | | | | |
| | REFERENCE NO. 13101-PJ0-660 13101-PJ0-661 13101-PH4-010 13101-PJ0-010 | | | | | | |
| | | | | | | | |
| B21A1 2056 cc 4 cyl. PRELUDE, F.I., DOHC4 1990-91  Surface Treatment Tin Coated Bore Clearance MRC: 0.020 mm MP: 16.00 mm | \varnothing 83.00 -0.8 CD 30.9 TL 65.4 | 2 - 1.2 1 - 2.8 | \varnothing 22.000 TL 56.00 | | | | TEIKIN NO. 44 |
| | TEIKIN NO. 38148 | TEIKIN NO. P 34101 | | | | | |
| | REFERENCE NO. 13101-PK3-A01 | | | | | | |
| | | | | | | | |

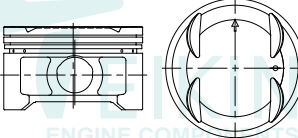
| ENGINE TYPE | PISTON | PISTON RING | PISTON PIN | PIN BUSHING | LINER | | LINER KIT SET |
|--|---|--------------------|--------------------------------|-------------|---------|-----------|---------------|
| | | | | | FLANGED | NO FLANGE | |
| B20B4 1972 cc 4 cyl. CRV F.I., DOHC 16V 1997-98 | \emptyset 84.00 -4.1 CD 29.6 TL 59.6 | 2 - 1.2 1 - 2.8 | \emptyset 21.000 TL 56.00 | | | | TEIKIN NO. |
|  | TEIKIN NO. 38154 | | TEIKIN NO. P 38151 | | | | |
| Surface Treatment None Bore Clearance MRC: 0.030 mm MP: 14.50 mm | REFERENCE NO. 13010-P3F-A00 13020-P3F-000 13101-P3F-A00 | | | | | | 45 |
| B20Z2 1997 cc 4 cyl. DOHC 16V 1999-2001 | \emptyset 84.00 -0.8 CD 29.6 TL 59.6 | 2 - 1.2 1 - 2.8 | \emptyset 21.000 TL 56.00 | | | | TEIKIN NO. |
|  | TEIKIN NO. 38171 | | TEIKIN NO. P 38151 | | | | |
| Surface Treatment None Bore Clearance MRC: 0.030 mm MP: 14.50 mm | REFERENCE NO. 13010-PHK-000 13101-PHK-000 | | | | | | 46 |
| F18A 2000 cc 4 cyl. | \emptyset 85.00 -2.5 CD 30.8 TL 65.3 | 2 - 1.2 1 - 2.8 | \emptyset 22.000 TL 56.00 | | | | TEIKIN NO. |
|  | TEIKIN NO. 38150 | | TEIKIN NO. P 34101 | | | | |
| Surface Treatment Tin Coated Bore Clearance MRC: 0.030 mm MP: 16.00 mm | REFERENCE NO. 13101-PT1-010 13101-PT1-000 | | | | | | 47 |
| F22A 2156 cc 4 cyl. | \emptyset 85.00 -4.0 CD 30.7 TL 65.2 | 2 - 1.2 1 - 2.8 | \emptyset 22.000 TL 56.00 | | | | TEIKIN NO. |
|  | TEIKIN NO. 38651 (38161) | | TEIKIN NO. P 34101 | | | | |
| Surface Treatment Tin Coated Bore Clearance MRC: 0.030 mm MP: 16.00 mm | REFERENCE NO. 13101-PT3-A01 | | | | | | 48 |

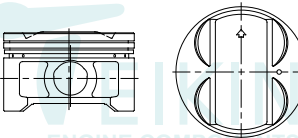
| ENGINE TYPE | PISTON | PISTON RING | PISTON PIN | PIN BUSHING | LINER | | LINER KIT SET |
|--|--|------------------------|---|-------------|---------|-----------|---------------|
| | | | | | FLANGED | NO FLANGE | |
| F23A1 2254 cc F23A4/ F23A7 ACCORD (LX,EX, VP) 98-02 F.I. SOHC 16V ODYSSEY 98 4 cyl. | Ø 86.00 -3.10 CD 30.1 TL 51.6 | 2 - 1.2 1 - 2.8 | Ø 21.965 TL 54.00  | | | | TEIKIN NO. |
|  | TEIKIN NO. 38180 | | TEIKIN NO. P 38172 | | | | |
| Surface Treatment None Bore Clearance MRC: 0.020 mm MP: 6.00 mm | REFERENCE NO. 13010-PAA-A00 | | | | | | 49 |
| F23A5 2254 cc ODYSSEY, ACCORD 1998-2001 F.I. SOHC 16V 4 cyl. | Ø 86.00 -4.3 CD 30.0 TL 51.5 | 2 - 1.2 1 - 2.8 | Ø 21.965 TL 54.00  | | | | TEIKIN NO. |
|  | TEIKIN NO. 38172 | | TEIKIN NO. P 38172 | | | | |
| Surface Treatment None Bore Clearance MRC: 0.020 mm MP: 6.00 mm | REFERENCE NO. 13010-PAB-A00 | | | | | | 50 |
| K20A2 2000 cc RSX TYPE S 2002-2006 CIVIC SI 2006 CSX TYPE S CIVIC TYPE S 2007 4 cyl. | Ø 86.00 +3.8 CD 30.0 TL 55.8 | 2 - 1.2 1 - 2.0 | Ø 21.965 TL 52.00  | | | | TEIKIN NO. |
|  | TEIKIN NO. 38190 | | TEIKIN NO. P 38174 | | | | |
| Surface Treatment Moly Skirt Bore Clearance MRC: 0.030 mm MP: 8.50 mm | REFERENCE NO. 13020-PRB-A01 13010-PRB-A01 13030-PRB-A01 | | | | | | 51 |
| K20A3 1998 cc CIVIC [Si] 2002-2005 VTEC DOHC 16V ACCURA RSX 2002-2005 4 cyl. | Ø 86.00 +2.5 CD 29.5 TL 54.0 | 2 - 1.2 1 - 2.0 | Ø 21.965 TL 52.00  | | | | TEIKIN NO. |
|  | TEIKIN NO. 38185 | | TEIKIN NO. P 38174 | | | | |
| Surface Treatment Moly Skirt Bore Clearance MRC: 0.030 mm MP: 8.50 mm | REFERENCE NO. 13010-PNC-010 | | | | | | 52 |

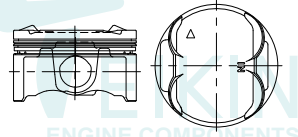
| ENGINE TYPE | PISTON | PISTON RING | PISTON PIN | PIN BUSHING | LINER | | LINER KIT SET |
|---|--|-----------------------------------|---|-------------|---------|-----------|---------------|
| | | | | | FLANGED | NO FLANGE | |
| K20A5 4 cyl. | \emptyset 86.00 -0.9 CD 29.5 TL 51.5 | 2 - 1.2 1 - 2.8 | \emptyset 21.965 TL 52.00  | | | | TEIKIN NO. |
|  | TEIKIN NO. 38199 | | TEIKIN NO. P 38174 | | | | |
| Surface Treatment Bore Clearance Moly Skirt MRC: 0.030 mm MP: 8.50 mm | REFERENCE NO. 13010-PNB-P01 | | | | | | 53 |
| J30A 2997 cc 6 cyl. | \emptyset 86.00 -0.9 CD 30.0 TL 51.5 | 2 - 1.2 1 - 2.8 | \emptyset 21.965 TL 54.00  | | | | TEIKIN NO. |
|  | TEIKIN NO. 38195 | | TEIKIN NO. P 38172 | | | | |
| Surface Treatment Bore Clearance None MRC: 0.030 mm MP: 7.00 mm | REFERENCE NO. 13010-P8A-A00 13030-P8A-A00 13040-P8A-A00 | | | | | | 54 |
| J30A4 2977 cc 6 cyl. V6 3.0L 2003-2005 ACCORD EX,LX SOHC 24V | \emptyset 86.00 +0.7 CD 30.0 TL 52.2 | 2 - 1.2 1 - 2.8 | \emptyset 21.965 TL 54.00  | | | | TEIKIN NO. |
|  | TEIKIN NO. 38178 | | TEIKIN NO. P 38172 | | | | |
| Surface Treatment Bore Clearance Moly Skirt MRC: 0.030 mm MP: 7.00 mm | REFERENCE NO. 13010-RCA-A00 | | | | | | 55 |
| ACCORD 4 cyl. | \emptyset 87.00 +3.5 CD 29.4 TL 53.9 | 1 - 1.2 1 - 1.0 1 - 2.0 | \emptyset 21.965 TL 52.00  | | | | TEIKIN NO. |
|  | TEIKIN NO. 38197 | | TEIKIN NO. P 43683 | | | | |
| Surface Treatment Bore Clearance Moly Skirt MRC: 0.030 mm MP: 7.00 mm | REFERENCE NO. 13010-5B0-Y00 | | | | | | 56 |

| ENGINE TYPE | PISTON | PISTON RING | PISTON PIN | PIN BUSHING | LINER | | LINER KIT SET |
|--|---|------------------------|----------------------------------|-------------|---------|-----------|---------------|
| | | | | | FLANGED | NO FLANGE | |
| H22A1 2157 cc PRELUDE [Si] VTEC, DOHC 16 V 1993-96 4 cyl. | \varnothing 87.00 +0.8 CD 31.0 TL 61.8 | 2 - 1.2 1 - 2.8 | \varnothing 22.000 TL 56.00 | | | | TEIKIN NO. |
| | TEIKIN NO. 38156 | | TEIKIN NO. P 34101 | | | | |
| | REFERENCE NO. 13010-P13-A00 | | | | | | |
| | Surface Treatment Bore Clearance Tin Coated MRC: 0.030 mm MP: 13.50 mm | | | | | | |
| H22A4 2157 cc PRELUDE [Si] VTEC, DOHC 16 V 1997-98 4 cyl. | \varnothing 87.00 +0.8 CD 31.0 TL 61.8 | 2 - 1.2 1 - 2.8 | \varnothing 21.965 TL 57.00 | | | | TEIKIN NO. |
| | TEIKIN NO. 38157 | | TEIKIN NO. P 38157 | | | | |
| | REFERENCE NO. 13010-P5M-A00 13101-P5M-A00 | | | | | | |
| | Surface Treatment Bore Clearance Tin Coated MRC: 0.030 mm MP: 13.70 mm | | | | | | |
| H23A1 2259 cc PRELUDE [Si, SE] DOHC 16 V 1992-96 4 cyl. | \varnothing 87.00 -3.1 CD 30.5 TL 60.5 | 2 - 1.2 1 - 2.8 | \varnothing 22.000 TL 56.00 | | | | TEIKIN NO. |
| | TEIKIN NO. 38158 | | TEIKIN NO. P 34101 | | | | |
| | REFERENCE NO. 13010-P14-A00 | | | | | | |
| | Surface Treatment Bore Clearance Tin Coated MRC: 0.030 mm MP: 13.00 mm | | | | | | |
| K24A 2400 cc 4 cyl. | \varnothing 87.00 -1.0 CD 29.3 TL 53.3 | 2 - 1.2 1 - 2.0 | \varnothing 21.965 TL 52.00 | | | | TEIKIN NO. |
| | TEIKIN NO. 38198 | | TEIKIN NO. P 38174 | | | | |
| | REFERENCE NO. 13010-RLF-000 | | | | | | |
| | Surface Treatment Bore Clearance Moly Skirt MRC: 0.030 mm MP: 7.50 mm | | | | | | |

57

58

59

60

| ENGINE TYPE | PISTON | PISTON RING | PISTON PIN | PIN BUSHING | LINER | | LINER KIT SET |
|--|---|------------------------|--------------------------------------|-------------|---------|-----------|----------------------|
| | | | | | FLANGED | NO FLANGE | |
| K24Z2 2354 cc K24Z3 4 cyl. | \varnothing 87.00 +4.2 CD 29.2 TL 57.4 | 2 - 1.2 1 - 2.0 | \varnothing 21.965 TL 52.00 | | | | TEIKIN NO. 65 |
| | TEIKIN NO. 38191 | TEIKIN NO. P 38174 | | | | | |
| | REFERENCE NO. 13010-R40-A00 | | | | | | |
| | Surface Treatment Bore Clearance Moly Skirt MRC: 0.030 mm MP: 7.50 mm | | | | | | |
| K24Z3 2400 cc ACURA TSX 09- 4 cyl. | \varnothing 87.00 +3.6 CD 29.2 TL 56.8 | 2 - 1.2 1 - 2.0 | \varnothing 21.965 TL 52.00 | | | | TEIKIN NO. 66 |
| | TEIKIN NO. 38188 | TEIKIN NO. P 38174 | | | | | |
| | REFERENCE NO. 13010-RL5-A00 | | | | | | |
| | Surface Treatment Bore Clearance Moly Skirt MRC: 0.030 mm MP: 8.50 mm | | | | | | |
| C27A4 2675 cc ACURA C27A1 6 cyl. ACCORD 1995-97 F.I., SOHC 24V | \varnothing 87.00 -1.6 CD 31.5 TL 63.0 | 2 - 1.2 1 - 4.0 | \varnothing 22.000 TL 56.00 | | | | TEIKIN NO. 67 |
| | TEIKIN NO. 38168 | TEIKIN NO. P 34101 | | | | | |
| | REFERENCE NO. 13010-P0G-A00 13101-PL2-000 | | | | | | |
| | Surface Treatment Bore Clearance Tin Coated MRC: 0.020 mm MP: 12.75 mm | | | | | | |
| J32A3 3200 cc J32A4 6 cyl. 3.2L V6 | \varnothing 89.00 +2.6 CD 30.0 TL 54.1 | 2 - 1.2 1 - 2.8 | \varnothing 21.965 TL 54.00 | | | | TEIKIN NO. 68 |
| | TEIKIN NO. 38193 | TEIKIN NO. P 38172 | | | | | |
| | REFERENCE NO. 13010-RDA-A00 | | | | | | |
| | Surface Treatment Bore Clearance Moly Skirt MRC: 0.030 mm MP: 7.50 mm | | | | | | |



| ENGINE TYPE | PISTON | PISTON RING | PISTON PIN | PIN BUSHING | LINER | | LINER KIT SET |
|---|--|--------------------|--------------------------|-------------|---------|-----------|---------------|
| | | | | | FLANGED | NO FLANGE | |
| J35A1 3474 cc V6 F.I 3.5L 1999-2001 ODYSSEY EX,LX SOHC 24V 6 cyl. | Ø 89.00 -2.4 CD 30.0 TL 51.5 | 2 - 1.2 1 - 2.8 | Ø 21.965 TL 54.00 | | | | TEIKIN NO. |
| | TEIKIN NO. 38176 | | TEIKIN NO. P 38172 | | | | |
| Surface Treatment Moly Skirt Bore Clearance MRC: 0.030 mm MP: 7.00 mm | REFERENCE NO. 13010-P8F-A00 13010-P8F-A01 13101-P8F-A00 | | | | | | 69 |
| J35A3 3471 cc V6 3.5L 2001 ACURA MDX,MDX TOURING 2002-2004 ODYSSEY EX.LX 2003-2004 PILOT 6 cyl. | Ø 89.00 -1.2 CD 30.0 TL 51.5 | 2 - 1.2 1 - 2.8 | Ø 21.965 TL 54.00 | | | | TEIKIN NO. |
| | TEIKIN NO. 38177 | | TEIKIN NO. P 38172 | | | | |
| Surface Treatment Moly Skirt Bore Clearance MRC: 0.030 mm MP: 7.00 mm | REFERENCE NO. 13010-PGK-A00 13010-PGK-A01 13010-RDJ-A00 13010-RGL-A00 | | | | | | 70 |
| J35A7 3500 cc 3.5L V6 6 cyl. | Ø 89.00 -0.5 CD 30.0 TL 51.5 | 2 - 1.2 1 - 2.8 | Ø 21.965 TL 54.00 | | | | TEIKIN NO. |
| | TEIKIN NO. 38192 | | TEIKIN NO. P 38172 | | | | |
| Surface Treatment Moly Skirt Bore Clearance MRC: 0.030 mm MP: 8.00 mm | REFERENCE NO. 13010-R70-A00 | | | | | | 71 |
| J35A8 3500 cc J35A3 3.5L V6 6 cyl. | Ø 89.00 +0.9 CD 30.0 TL 52.4 | 2 - 1.2 1 - 2.8 | Ø 21.965 TL 54.00 | | | | TEIKIN NO. |
| | TEIKIN NO. 38194 | | TEIKIN NO. P 38172 | | | | |
| Surface Treatment Moly Skirt Bore Clearance MRC: 0.030 mm MP: 8.00 mm | REFERENCE NO. 13010-RJA-A00 13020-RJA-A00 | | | | | | 72 |



SUITABLE FOR

HONDA

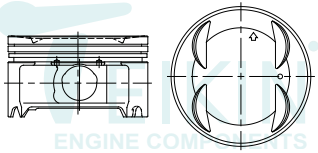
GASOLINE

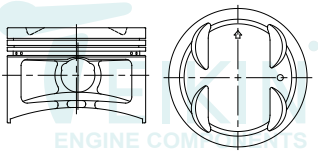

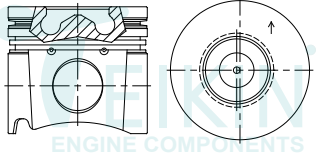
| ENGINE TYPE | PISTON | PISTON RING | PISTON PIN | PIN BUSHING | LINER | | LINER KIT SET | | |
|--|---|--------------------|--|-------------|---------|-----------|--|------------------------------|----|
| | | | | | FLANGED | NO FLANGE | | | |
| J35Z3 6 cyl.  Surface Treatment Moly Skirt Bore Clearance MRC: 0.030 mm MP: 8.00 mm | Ø 89.00 -1.5 CD 30.0 TL 51.5 | 2 - 1.2 1 - 2.8 | Ø 21.965 TL 54.00  | | | | TEIKIN NO. 38196 REFERENCE NO. 13010-R72-A00 | TEIKIN NO. P 38172 | 73 |
| C32A 3206 cc 6 cyl.  Surface Treatment Tin Coated Bore Clearance MRC: 0.030 mm MP: 12.50 mm | Ø 90.00 -0.35 CD 30.9 TL 61.8 | 2 - 1.2 1 - 2.8 | Ø 22.000 TL 57.00 | | | | TEIKIN NO. 38662 REFERENCE NO. 13101-PY3-A02 13101-PY3-A00 13101-PY3-000 13102-PY3-A02 | TEIKIN NO. P 38662 | 74 |

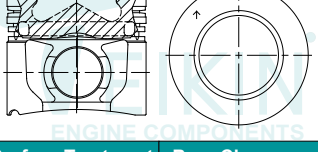
| ENGINE TYPE | PISTON | PISTON RING | PISTON PIN | PIN BUSHING | LINER | | | LINER KIT SET |
|---|---|----------------------------------|---|-------------|---|------------------------|---|---------------|
| | | | | | FLANGED | NO FLANGE | | |
| 20T2N/20T2 TURBO 1994 cc ROVER ACCORD 2.0 TDI CIVIC 2.0 TDI 4 cyl. | \varnothing 84.45 -17.0 CD 48.0 TL 77.0 | 1 - 3.0 FK 1 - 2.0 1 - 3.0 | \varnothing 30.000 TL 70.00  | | TL 158.5 OD 88.0 FT 4.0 FD 90.5 | 158.50 88.0 88.0 | TEIKIN NO. LKSX 38658A LKSF 38658A | |
|  | TEIKIN NO. 38658A | TEIKIN NO. R 38658 | TEIKIN NO. P 38658 | | TEIKIN NO. LSX 38658 LSF 38658 | | 75 | |
| Surface Treatment Bore Clearance Chromated Moly Skirt MRC: 0.088 mm MP: 10.50 mm | REFERENCE NO. 13011-P5T-G00 | | REFERENCE NO. K-89536190 | | | | | |
| | | | | | | | | |
| N22A1/N22A2 2204 cc ACCORD - CR - V 2.2D I-CTD 4 cyl. | \varnothing 85.00 -15.8 CD 47.0 TL 73.0 | 1 - 2.0 FK 1 - 2.0 1 - 3.0 | \varnothing 30.00 TL 69.00  | | | | TEIKIN NO. | |
|  | TEIKIN NO. 38661AG | | TEIKIN NO. P 38661 | | | | 76 | |
| Surface Treatment Bore Clearance Moly Skirt MRC: 0.050 mm MP: 7.00 mm | REFERENCE NO. 13010-RMA-E00 13020-RMA-E00 13030-RMA-E00 | | | | | | | |
| | | | | | | | | |

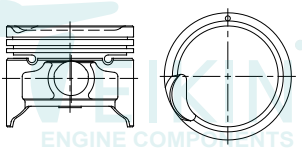
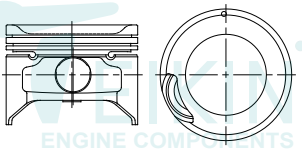
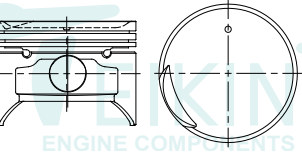
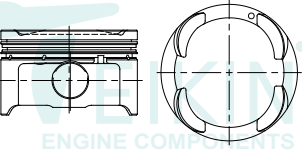
| ENGINE TYPE | PISTON | PISTON RING | PISTON PIN | PIN BUSHING | LINER | | LINER KIT SET |
|---|--|--|--------------------------------|-------------|---------|-----------|---------------|
| | | | | | FLANGED | NO FLANGE | |
| ATOZ-II 800 cc 4 cyl. | \emptyset 63.00 -2.1 CD 26.0 TL 50.0 | 1 - 1.2 1 - 1.5 1 - 2.8 | \emptyset 17.000 TL 46.50 | | | | TEIKIN NO. |
|  | | TEIKIN NO. | TEIKIN NO. | | | | |
| Surface Treatment Bore Clearance None MRC: 0.030 mm MP: 11.50 mm | | REFERENCE NO. | | | | | |
| | | 23410-02510 | | | | | 1 |
| ATOZ 1000 cc 4 cyl. | \emptyset 66.00 -4.5 CD 25.0 TL 50.0 | 2 - 1.2 1 - 2.5 | \emptyset 17.000 TL 46.50 | | | | TEIKIN NO. |
|  | | TEIKIN NO. | TEIKIN NO. | | | | |
| Surface Treatment Bore Clearance None MRC: 0.030 mm MP: 14.00 mm | | REFERENCE NO. | | | | | |
| | | 23410-02710 23410-02700 23410-02720 23410-02310 | | | | | 2 |
| SANTRO XING 1.1 1100 cc 4 cyl. | \emptyset 66.00 -3.1 CD 25.0 TL 49.7 | 2 - 1.2 1 - 2.5 | \emptyset 17.000 TL 45.00 | | | | TEIKIN NO. |
|  | | TEIKIN NO. | TEIKIN NO. | | | | |
| Surface Treatment Bore Clearance None MRC: 0.030 mm MP: 13.00 mm | | REFERENCE NO. | | | | | |
| | | 23410-02840 | | | | | 3 |
| KAPPA2 1197 cc 4 cyl. | \emptyset 71.00 -2.2 CD 26.2 TL 44.2 | 1 - 1.0 1 - 1.2 1 - 2.0 | \emptyset 18.000 TL 47.50 | | | | TEIKIN NO. |
|  | | TEIKIN NO. | TEIKIN NO. | | | | |
| Surface Treatment Bore Clearance Tin Coated Moly Skirt MRC: 0.030 mm MP: 6.50 mm | | REFERENCE NO. | | | | | |
| | | 23041-03140 | | | | | 4 |

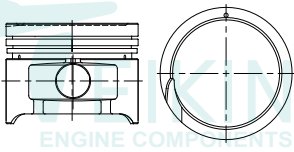
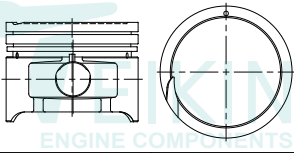
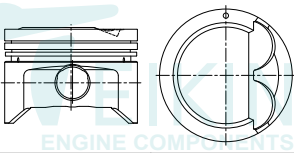
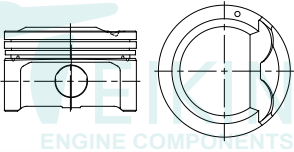
| ENGINE TYPE | PISTON | PISTON RING | PISTON PIN | PIN BUSHING | LINER | | LINER KIT SET |
|---|--|-------------------------------|--------------------------------|-------------|---------|-----------|---|
| | | | | | FLANGED | NO FLANGE | |
| X3, G4EH 1300 cc 4 cyl.  Surface Treatment None Bore Clearance MRC: 0.030 mm MP: 9.00 mm | \emptyset 71.50 -1.1 CD 31.2 TL 54.3 | 2 - 1.5 1 - 3.0 | \emptyset 18.010 TL 47.50 | | | | TEIKIN NO. REFERENCE NO. 23410-22360 23410-22350/70 23410-22250/60 23410-22270 |
| | TEIKIN NO. 51600 (51106) | TEIKIN NO. P 51600 | | | | | |
| | | | | | | | |
| | | | | | | | |
| X3-II 1341 cc 4 cyl.  Surface Treatment Tin Coated Bore Clearance MRC: 0.030 mm MP: 9.00 mm | \emptyset 71.50 -0.7 CD 30.8 TL 53.8 | 2 - 1.5 1 - 3.0 | \emptyset 18.010 TL 47.50 | | | | TEIKIN NO. REFERENCE NO. 23410-22712 23410-22971-4 23410-22880 |
| | TEIKIN NO. 51129 | TEIKIN NO. P 51600 | | | | | |
| | | | | | | | |
| | | | | | | | |
| ACCENT 1.5L 1500 cc 4 cyl.  Surface Treatment Tin Coated Bore Clearance MRC: 0.030 mm MP: 11.00 mm | \emptyset 75.50 +1.0 CD 30.5 TL 54.5 | 1 - 1.2 1 - 1.5 1 - 3.0 | \emptyset 18.000 TL 47.50 | | | | TEIKIN NO. REFERENCE NO. 23410-22511 |
| | TEIKIN NO. 51134 | TEIKIN NO. P 30110 | | | | | |
| | | | | | | | |
| | | | | | | | |
| ATTITUDE 1400 cc 4 cyl.  Surface Treatment Moly Skirt Bore Clearance MRC: 0.030 mm MP: 5.00 mm | \emptyset 75.50 +2.2 CD 28.7 TL 48.0 | 2 - 1.2 1 - 2.0 | \emptyset 18.000 TL 47.50 | | | | TEIKIN NO. REFERENCE NO. 23410-26410 |
| | TEIKIN NO. 51128 | TEIKIN NO. P 30110 | | | | | |
| | | | | | | | |
| | | | | | | | |

H

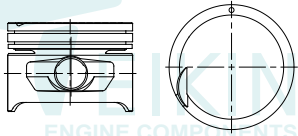
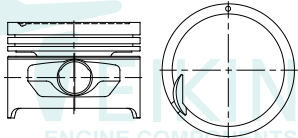
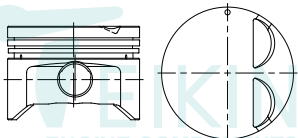
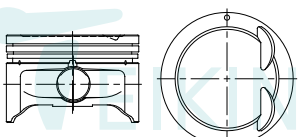
| ENGINE TYPE | PISTON | PISTON RING | PISTON PIN | PIN BUSHING | LINER | | LINER KIT SET |
|---|--|-------------------------------|--------------------------------|-------------|---------|-----------|---------------|
| | | | | | FLANGED | NO FLANGE | |
| G4EB 1500 cc 4 cyl. ACCENT 2000-03 F.I. SOHC 12V | \emptyset 75.50 -0.2 CD 30.7 TL 53.7 | 2 - 1.5 1 - 3.0 | \emptyset 18.000 TL 47.50 | | | | TEIKIN NO. |
|  | TEIKIN NO. 51119 | | TEIKIN NO. P 30110 | | | | |
| Surface Treatment Bore Clearance None MRC: 0.030 mm MP: 8.75 mm | REFERENCE NO. 23410-22612 23410-22921/22 23410-22961/62 | | | | | | 9 |
| G4EK - ALPHA - F1 1495 cc 4 cyl. G4AE, G4AEB ACCENT 1500i CS, RS, SCOUPL 1.5 LS/GT 12 V | \emptyset 75.50 -0.75 CD 31.4 TL 54.4 | 2 - 1.5 1 - 3.0 | \emptyset 18.010 TL 47.50 | | | | TEIKIN NO. |
|  | TEIKIN NO. 51104 | | TEIKIN NO. P 51600 | | | | |
| Surface Treatment Bore Clearance Tin Coated MRC: 0.030 mm MP: 8.75 mm | REFERENCE NO. 23410-22410 23410-22450 23410-22400 23410-22420 | | | | | | 10 |
| G4FK 1495 cc 4 cyl. ACCENT 1996-98 F.I. DOHC 16V | \emptyset 75.50 -4.15 CD 30.5 TL 53.5 | 1 - 1.2 1 - 1.5 1 - 3.0 | \emptyset 18.000 TL 47.50 | | | | TEIKIN NO. |
|  | TEIKIN NO. 51116 | | TEIKIN NO. P 30110 | | | | |
| Surface Treatment Bore Clearance None MRC: 0.020 mm MP: 11.00 mm | REFERENCE NO. 23410-26012 23410-26913 23410-26916 23410-26919 | | | | | | 11 |
| 1.6L 1600 cc 4 cyl. ACCENT G4ED | \emptyset 76.50 -0.8 CD 28.4 TL 50.4 | 2 - 1.2 1 - 2.5 | \emptyset 18.000 TL 47.50 | | | | TEIKIN NO. |
|  | TEIKIN NO. 51115 | | TEIKIN NO. P 30110 | | | | |
| Surface Treatment Bore Clearance Tin Coated MRC: 0.020 mm MP: 10.50 mm | REFERENCE NO. 23410-26111 | | | | | | 12 |

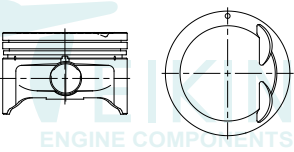
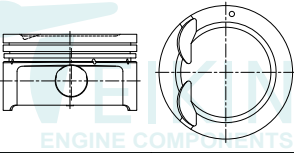
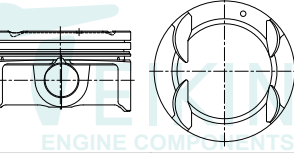
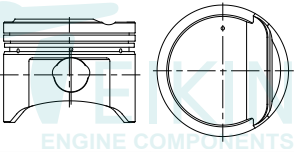
| ENGINE TYPE | PISTON | PISTON RING | PISTON PIN | PIN BUSHING | LINER | | LINER KIT SET |
|--|--|---|--------------------------------|-------------|---------|-----------|---------------|
| | | | | | FLANGED | NO FLANGE | |
| XD 1600 cc ADVANTE 4 cyl. 1600cc DOHC | \emptyset 76.50 -0.5 CD 28.2 TL 50.2 | 2 - 1.2 1 - 2.0 | \emptyset 18.010 TL 47.50 | | | | TEIKIN NO. |
|  | TEIKIN NO. 51121 | | TEIKIN NO. P 51600 | | | | |
| Surface Treatment Tin Coated Moly Skirt | Bore Clearance MRC: 0.030 mm MP: 10.50 mm | REFERENCE NO. 23410-26510 23410-23917 | | | | | 13 |
| AVANTE 1.6L 1600 cc 4 cyl. | \emptyset 77.00 -1.0 CD 26.9 TL 43.9 | 2 - 1.2 1 - 2.0 | \emptyset 18.000 TL 53.00 | | | | TEIKIN NO. |
|  | TEIKIN NO. 51136 | | TEIKIN NO. P 46332 | | | | |
| Surface Treatment Tin Coated Moly Skirt | Bore Clearance MRC: 0.030 mm MP: 5.00 mm | REFERENCE NO. | | | | | 14 |
| G4FC-II 4 cyl. ELANTRA I30 ~ VELOSTER A2 ~ AM ~ SOUL (11-) DOHC 16V | \emptyset 77.00 -0.9 CD 26.9 TL 43.9 | 2 - 1.2 1 - 2.0 | \emptyset 18.000 TL 53.00 | | | | TEIKIN NO. |
|  | TEIKIN NO. 51145 | | TEIKIN NO. P 46332 | | | | |
| Surface Treatment Anodized Crown Moly Skirt 1st Ring Anodized | Bore Clearance MRC: 0.030 mm MP: 5.50 mm | REFERENCE NO. 23410-2B900 23410-2B910 23410-2B920 | | | | | 15 |
| J2 (BETA) 1599 cc 4 cyl. E LANTRA 1.6 GLS DOHC 16 VALVE 1994 - ON | \emptyset 77.40 +1.8 CD 31.0 TL 60.8 | 2 - 1.2 1 - 2.5 | \emptyset 20.000 TL 59.00 | | | | TEIKIN NO. |
|  | TEIKIN NO. 51101 | | TEIKIN NO. P 51101 | | | | |
| Surface Treatment Tin Coated | Bore Clearance MRC: 0.030 mm MP: 15.40 mm | REFERENCE NO. 23410-23100/10/20 23410-23105/15/25 23410-23155/65/75 | | | | | 16 |

H

| ENGINE TYPE | PISTON | PISTON RING | PISTON PIN | PIN BUSHING | LINER | | LINER KIT SET |
|--|---|-------------------------------|----------------------|-------------|---------|-----------|---------------|
| | | | | | FLANGED | NO FLANGE | |
| 15D 1500 cc ELANTRA 1.5L 4 cyl. | Ø 79.70 +2.0 CD 32.4 TL 66.4 | 1 - 1.2 1 - 1.5 1 - 3.0 | Ø 21.000 TL 66.00 | | | | TEIKIN NO. |
| | | TEIKIN NO. | TEIKIN NO. | | | | |
| Surface Treatment: Tin Coated Bore Clearance: MRC: 0.030 mm, MP: 16.50 mm | | REFERENCE NO. | | | | | |
| | | | | | | | 17 |
| Y2 1800 cc 1800 CC SOHC 4 cyl. | Ø 80.60 +3.0 CD 35.0 TL 74.9 | 2 - 1.5 1 - 4.0 | Ø 21.000 TL 72.50 | | | | TEIKIN NO. |
| | | TEIKIN NO. | TEIKIN NO. | | | | |
| Surface Treatment: Tin Coated Bore Clearance: MRC: 0.030 mm, MP: 19.30 mm | | REFERENCE NO. | | | | | |
| | | | | | | | 18 |
| G4DM 1836 cc GACN ELANTRA 1993-95 F.I., DOHC, 16V 4 cyl. | Ø 81.50 -1.15 CD 34.7 TL 67.0 | 1 - 1.2 1 - 1.5 1 - 3.0 | Ø 21.000 TL 66.00 | | | | TEIKIN NO. |
| | | TEIKIN NO. | TEIKIN NO. | | | | |
| Surface Treatment: Tin Coated Bore Clearance: MRC: 0.030 mm, MP: 16.00 mm | | REFERENCE NO. | | | | | |
| | | | | | | | 19 |
| 2.0L 2000 cc 4 cyl. | Ø 82.00 +0.3 CD 31.0 TL 57.8 | 2 - 1.2 1 - 2.5 | Ø 20.000 TL 59.00 | | | | TEIKIN NO. |
| | | TEIKIN NO. | TEIKIN NO. | | | | |
| Surface Treatment: Tin Coated Bore Clearance: MRC: 0.030 mm, MP: 10.00 mm | | REFERENCE NO. | | | | | |
| | | | | | | | 20 |

H

| ENGINE TYPE | PISTON | PISTON RING | PISTON PIN | PIN BUSHING | LINER | | LINER KIT SET |
|---|--|------------------------|--------------------------------|-------------|---------|-----------|---------------|
| | | | | | FLANGED | NO FLANGE | |
| G4DR - BETA - J2 1836 cc 4 cyl. G4GB ELANTRA 1.8 GLi 1994-ON TIBURON 1996-1998 | \emptyset 82.00 +2.1 CD 31.1 TL 63.2 | 2 - 2.0 1 - 4.0 | \emptyset 20.000 TL 59.00 | | | | TEIKIN NO. |
| | TEIKIN NO. 51105 | | TEIKIN NO. P 51101 | | | | |
| Surface Treatment Tin Coated Bore Clearance MRC: 0.030 mm MP: 17.00 mm | | | | | | | 21 |
| G4DR - BETA - J2 - II 1800 cc 4 cyl. G4GM LAVITA ADVANTE 1.8L | \emptyset 82.00 +2.2 CD 30.9 TL 63.2 | 2 - 1.2 1 - 2.5 | \emptyset 20.000 TL 59.00 | | | | TEIKIN NO. |
| | TEIKIN NO. 51120 | | TEIKIN NO. P 51101 | | | | |
| Surface Treatment Tin Coated Bore Clearance MRC: 0.030 mm MP: 17.00 mm | REFERENCE NO. 23410-23010 23410-23060 23410-26901/02 23410-23931/32 | | | | | | 22 |
| G4GF 1975 cc 4 cyl. | \emptyset 82.00 +1.0 CD 31.0 TL 62.0 | 2 - 1.2 1 - 2.5 | \emptyset 20.000 TL 59.00 | | | | TEIKIN NO. |
| | TEIKIN NO. 51131 | | TEIKIN NO. P 51101 | | | | |
| Surface Treatment Tin Coated Bore Clearance MRC: 0.030 mm MP: 17.00 mm | REFERENCE NO. 23410-23210 | | | | | | 23 |
| MATRIX 1.8L 1800 cc 4 cyl. | \emptyset 82.00 +1.9 CD 31.0 TL 59.4 | 2 - 1.2 1 - 2.5 | \emptyset 20.000 TL 59.00 | | | | TEIKIN NO. |
| | TEIKIN NO. 51122 | | TEIKIN NO. P 51101 | | | | |
| Surface Treatment Tin Coated Bore Clearance MRC: 0.030 mm MP: 10.00 mm | REFERENCE NO. 23410-23610 | | | | | | 24 |

H

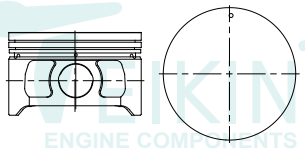
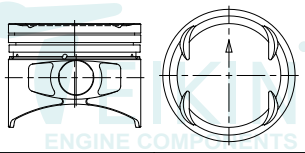
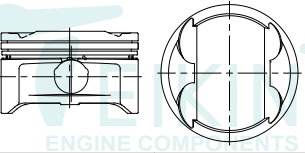
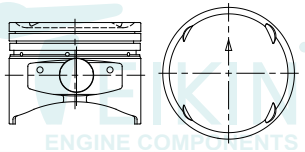
| ENGINE TYPE | PISTON | PISTON RING | PISTON PIN | PIN BUSHING | LINER | | LINER KIT SET |
|--|--|-------------------------------|--------------------------------|-------------|---------|-----------|---------------|
| | | | | | FLANGED | NO FLANGE | |
| G6BV DELTA 2493 cc 6 cyl. SONATA OPTIMA F.I., DOHC 24V 1999-2001 | \emptyset 84.00 CD 30.6 TL 52.5 | 2 - 1.2 1 - 2.5 | \emptyset 21.000 TL 59.00 | | | | TEIKIN NO. |
|  | TEIKIN NO. 51111 | | TEIKIN NO. P 45131 | | | | |
| Surface Treatment Bore Clearance Tin Coated MRC: 0.030 mm MP: 8.75 mm | REFERENCE NO. 23410-37120 | | | | | | 25 |
| G4JP 1997 cc 4 cyl. | \emptyset 85.00 -1.3 CD 34.7 TL 66.6 | 1 - 1.2 1 - 1.5 1 - 2.8 | \emptyset 22.000 TL 62.00 | | | | TEIKIN NO. |
|  | TEIKIN NO. 51130 | | TEIKIN NO. P 43222 | | | | |
| Surface Treatment Bore Clearance Tin Coated MRC: 0.030 mm MP: 16.50 mm | REFERENCE NO. 23410-38190 | | | | | | 26 |
| G4KD 4 cyl. GF10 - IX35 SONATA NF - TUCSON KIA CERATO - FORTE | \emptyset 86.00 +1.0 CD 27.5 TL 51.5 | 2 - 1.2 1 - 2.0 | \emptyset 21.000 TL 59.00 | | | | TEIKIN NO. |
|  | TEIKIN NO. 51144 | | TEIKIN NO. P 45131 | | | | |
| Surface Treatment Bore Clearance Tin Coated Moly Skirt MRC: 0.030 mm MP: 9.00 mm | REFERENCE NO. 23410-2G000 23410-2G010 23410-2G020 | | | | | | 27 |
| G6BV 4 cyl. G4JS | \emptyset 86.50 -3.5 CD 34.6 TL 66.7 | 1 - 1.2 1 - 1.5 1 - 2.8 | \emptyset 22.000 TL 62.00 | | | | TEIKIN NO. |
|  | TEIKIN NO. 51110 | | TEIKIN NO. P 43222 | | | | |
| Surface Treatment Bore Clearance Tin Coated MRC: 0.030 mm MP: 16.50 mm | REFERENCE NO. 23410-38210 23410-38290 | | | | | | 28 |

| ENGINE TYPE | PISTON | PISTON RING | PISTON PIN | PIN BUSHING | LINER | | LINER KIT SET |
|---|--|------------------------|--|-------------|---------|-----------|---------------|
| | | | | | FLANGED | NO FLANGE | |
| DELTA 2.7L 6 cyl. | \emptyset 86.70 -0.8 CD 30.5 TL 54.0 | 2 - 1.2 1 - 2.0 | \emptyset 21.000 TL 59.00 | | | | TEIKIN NO. |
| | TEIKIN NO. 51124 | | TEIKIN NO. P 45131 | | | | |
| Surface Treatment Tin Coated Moly Skirt | Bore Clearance MRC: 0.030 mm MP: 9.00 mm | | REFERENCE NO. 23410-3E001 | | | | 29 |
| G6BA SONATA SANTA FE, OPTIMA F.I., DOHC 24V 2000-02 2657 cc 6 cyl. | \emptyset 86.70 -0.9 CD 30.5 TL 54.0 | 2 - 1.2 1 - 2.5 | \emptyset 21.000 TL 59.00 | | | | TEIKIN NO. |
| | TEIKIN NO. 51113 | | TEIKIN NO. P 45131 | | | | |
| Surface Treatment Tin Coated | Bore Clearance MRC: 0.020 mm MP: 9.00 mm | | REFERENCE NO. 23410-37100 23410-37310 | | | | 30 |
| SANTA FE 6 cyl. | \emptyset 86.70 -0.6 CD 30.5 TL 54.0 | 2 - 1.2 1 - 2.0 | \emptyset 21.000 TL 59.00 | | | | TEIKIN NO. |
| | TEIKIN NO. 51138 | | TEIKIN NO. P 45131 | | | | |
| Surface Treatment Tin Coated Moly Skirt | Bore Clearance MRC: 0.030 mm MP: 9.50 mm | | REFERENCE NO. | | | | 31 |
| SONATA 2.4 L THETA 2.4 MPI 2400 cc 4 cyl. | \emptyset 88.00 -1.7 CD 27.5 TL 51.5 | 2 - 1.2 1 - 2.0 | \emptyset 21.000 TL 59.00 | | | | TEIKIN NO. |
| | TEIKIN NO. 51135 | | TEIKIN NO. P 45131 | | | | |
| Surface Treatment Tin Coated Moly Skirt | Bore Clearance MRC: 0.030 mm MP: 10.00 mm | | REFERENCE NO. 23410-25201 | | | | 32 |



H







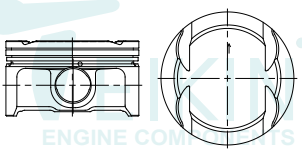
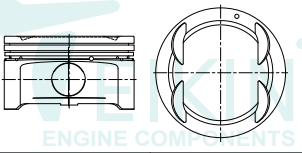

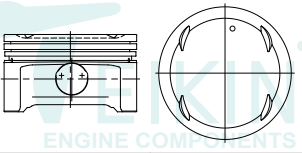
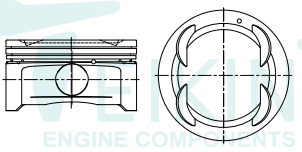
SUITABLE FOR

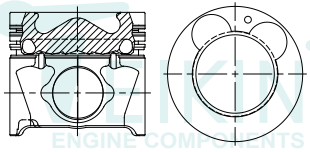
HYUNDAI

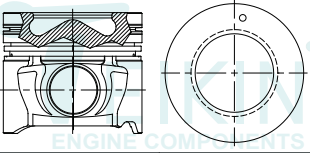

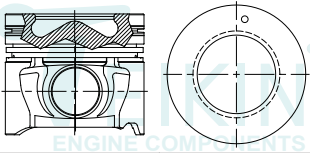

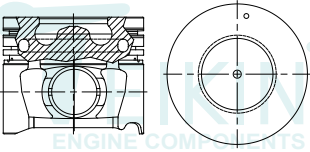



GASOLINE

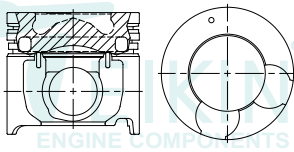

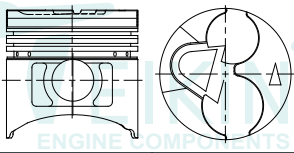

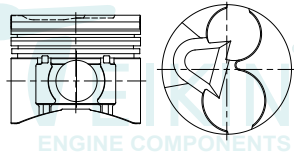

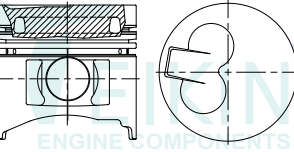

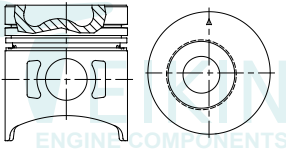

| ENGINE TYPE | PISTON | PISTON RING | PISTON PIN | PIN BUSHING | LINER | | LINER KIT SET |
|---|---------------------------------------|--------------------|---|-------------|---------|-----------|---------------|
| | | | | | FLANGED | NO FLANGE | |
| G6DB 3300 cc 3342 CC SONATA 2006- 6 cyl. | Ø 92.00 -0.5 CD 30.7 TL 52.0 | 2 - 1.2 1 - 2.0 | Ø 23.000 TL 64.00 | | | | TEIKIN NO. |
|  | TEIKIN NO. 51139 | | TEIKIN NO. P 51102 | | | | |
| Surface Treatment Bore Clearance Moly Skirt Anodized Crown 1st Ring Anodized | MRC: 0.030 mm MP: 6.50 mm | | | | | | |
| | | | | | | | 33 |
| SONATA 3.3L 3300 cc 6 cyl. | Ø 92.00 -0.6 CD 30.7 TL 51.8 | 2 - 1.2 1 - 2.0 | Ø 23.000 TL 63.00 | | | | TEIKIN NO. |
|  | TEIKIN NO. 51133 | | TEIKIN NO. P 51132 | | | | |
| Surface Treatment Bore Clearance Tin Coated Moly Skirt | MRC: 0.030 mm MP: 6.50 mm | | | | | | |
| | | | | | | | 34 |
| XG350 6 cyl. | Ø 93.00 -2.5 CD 31.2 TL 54.2 | 2 - 1.5 1 - 3.0 | Ø 22.000 TL 64.00  | | | | TEIKIN NO. |
|  | TEIKIN NO. 51123 | | TEIKIN NO. P 43220 | | | | |
| Surface Treatment Bore Clearance Tin Coated | MRC: 0.030 mm MP: 8.00 mm | | | | | | |
| | | | | | | | 35 |
| SONATA 3.8L 3800 cc LAMBDA 6 cyl. | Ø 96.00 -2.1 CD 29.1 TL 52.0 | 2 - 1.2 1 - 2.0 | Ø 23.000 TL 63.00 | | | | TEIKIN NO. |
|  | TEIKIN NO. 51132 | | TEIKIN NO. P 51132 | | | | |
| Surface Treatment Bore Clearance Tin Coated Moly Skirt | MRC: 0.030 mm MP: 9.00 mm | | | | | | |
| | | | | | | | 36 |

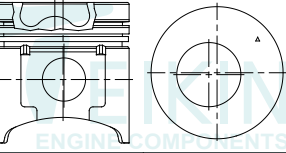
| ENGINE TYPE | PISTON | PISTON RING | PISTON PIN | PIN BUSHING | LINER | | LINER KIT SET | |
|---|--|--|---|-------------------------------------|---|----------------|---|-----------|
| | | | | | FLANGED | NO FLANGE | | |
| i20 MAGNA CDRI 4 cyl.  | \emptyset 75.00 -11.8 CD 44.7 TL 68.4 | 2 - 1.75 1 - 3.0 | \emptyset 28.000 TL 61.00  | | | | TEIKIN NO. REFERENCE NO. 23410-2A951 | 37 |
| | TEIKIN NO. 51142AG | | TEIKIN NO. P 44671 | | | | | |
| | Surface Treatment Bore Clearance Moly Skirt MRC: 0.030 mm 2nd Ring Anodized MP: 8.00 mm | | | | | | | |
| | | | | | | | | |
| D3EA 1493 cc 3 cyl.  | \emptyset 83.00 -14.0 CD 46.3 TL 72.3 | 1 - 2.0 FK 1 - 2.0 1 - 3.0 | \emptyset 28.000 TL 65.50  | | TL 153.5 OD 86.0 FT 4.8 FD 89.0 | 153.5 86.0 | TEIKIN NO. LKSF 51604A LKSX 51604A | 38 |
| | TEIKIN NO. 51604A | TEIKIN NO. R 51604 | TEIKIN NO. P 51604 | TEIKIN NO. B 51604 | TEIKIN NO. LSF 51604 LSX 51604 | | | |
| | Surface Treatment Bore Clearance Moly Skirt MRC: 0.030 mm MP: 7.00 mm | REFERENCE NO. 23410-27921 | REFERENCE NO. 23040-27900/1/2 23040-27910/1/2 23040-27920/1/2 | REFERENCE NO. 23517-27000 | REFERENCE NO. | | | |
| | | | | | | | | |
| D4EA 1991 cc 4 cyl.  | \emptyset 83.00 -14.0 CD 46.3 TL 72.3 | 1 - 2.0 FK 1 - 2.0 1 - 3.0 | \emptyset 28.000 TL 65.50  | | TL 153.5 OD 86.0 FT 4.8 FD 89.0 | 153.5 86.0 | TEIKIN NO. LKSF 51604A-4 LKSX 51604A-4 | 39 |
| | TEIKIN NO. 51604A-4 | TEIKIN NO. R 51604 | TEIKIN NO. P 51604 | TEIKIN NO. B 51604 | TEIKIN NO. LSF 51604 LSX 51604 | | | |
| | Surface Treatment Bore Clearance Moly Skirt MRC: 0.030 mm MP: 7.00 mm | REFERENCE NO. 23410-27901/3/4 23410-27921/3/4 | REFERENCE NO. 23040-27900 23040-27901/2 23040-27910/1/2 | REFERENCE NO. 23517-27000 | REFERENCE NO. | | | |
| | | | | | | | | |
| D4EB-F / D4EB-G 2188 cc SANTA FE 2.2 CRDI 4 cyl.  | \emptyset 87.00 -17.4 CD 46.3 TL 72.3 | 1 - 2.5 FK 1 - 2.0 1 - 3.0 | \emptyset 28.000 TL 72.00  | | TL 162.0 OD 91.05 FT 4.0 FD 92.5 | 162.0 91.05 | TEIKIN NO. LKSF 51605 LKSX 51605 | 40 |
| | TEIKIN NO. 51605AG | TEIKIN NO. R 51605 | TEIKIN NO. P 51605 | TEIKIN NO. B 51604 | TEIKIN NO. LSF 51605 LSX 51605 | | | |
| | Surface Treatment Bore Clearance Moly Skirt MRC: 0.070 mm MP: 7.50 mm | REFERENCE NO. 23410-27940/1/2/3/4 | REFERENCE NO. 23040-27940/1/2 | REFERENCE NO. 23517-27000 | REFERENCE NO. | | | |
| | | | | | | | | |

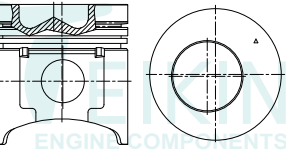
H

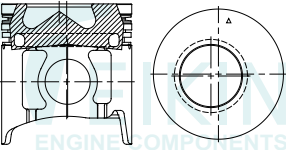

| ENGINE TYPE | PISTON | PISTON RING | PISTON PIN | PIN BUSHING | LINER | | | LINER KIT SET |
|---|---|---|---|----------------------|---|----------------|--|---------------|
| | | | | | FLANGED | NO FLANGE | | |
| D4CB CRDI 2497 cc 4 cyl.  Surface Treatment Tin Coated Moly Skirt Bore Clearance MRC: 0.070 mm MP: 9.00 mm | \varnothing 91.00 -15.0 CD 54.2 TL 83.7 | 1 - 2.5 HK 1 - 2.0 1 - 3.0 | \varnothing 33.000 TL 75.00  | | TL 170.5 OD 94.15 FT 2.0 FD 98.15 | 170.5 94.15 | TEIKIN NO. LKSF 51603AG LKSX 51603AG | |
| | TEIKIN NO. | TEIKIN NO. | TEIKIN NO. | TEIKIN NO. | TEIKIN NO. | | | |
| | REFERENCE NO. | REFERENCE NO. | REFERENCE NO. | REFERENCE NO. | REFERENCE NO. | | | |
| | 23410-4A900/1/2 23410-4A910/1/2/3/4 | 23040-4A900/1/2 23040-4A910/1/2 | P 51603 | B 51603 | LSF 51603 LSX 51603 21131-4A000 | | | |
| | | | | | | | | 41 |
| D4BA 2400 cc 4 cyl.  Surface Treatment Tin Coated Bore Clearance MRC: 0.030 mm MP: 18.50 mm | \varnothing 91.10 -3.3 CD 48.7 TL 88.7 | 2 - 2.0 1 - 3.0 | \varnothing 29.000 TL 75.00  | | TL 165.0 OD 94.1 FT 2.0 FD 98.1 | 164.5 94.2 | TEIKIN NO. LKFX 51108 LKSF 51108 LKSX 51108 LKFX 51108A LKSF 51108A LKSX 51108A | |
| | TEIKIN NO. | TEIKIN NO. | TEIKIN NO. | TEIKIN NO. | TEIKIN NO. | | | |
| | REFERENCE NO. | REFERENCE NO. | REFERENCE NO. | REFERENCE NO. | REFERENCE NO. | | | |
| | 23410-42201 23410-42211 23410-42221 | 23040-42200 23040-42202 23040-42210 | P 43171 | B 51102 | LSF 51102 LSX 51102 LFX 51102 MD050009 MD103648 21131-42001 | | | |
| | | | | | | | | 42 |
| D4BB 2600 cc 4 cyl. T2 MITSUBISHI 4D57  Surface Treatment Tin Coated Moly Skirt Bore Clearance MRC: 0.030 mm MP: 11.80 mm | \varnothing 91.10 -3.2 CD 46.2 TL 76.2 | 2 - 2.0 1 - 3.0 | \varnothing 29.000 TL 75.00  | | TL 165.0 OD 94.1 FT 2.0 FD 98.1 | 165.0 94.2 | TEIKIN NO. LKSF 51102 LKSX 51102 LKFX 51102 LKSF 51102A LKSX 51102A LKFX 51102A | |
| | TEIKIN NO. | TEIKIN NO. | TEIKIN NO. | TEIKIN NO. | TEIKIN NO. | | | |
| | REFERENCE NO. | REFERENCE NO. | REFERENCE NO. | REFERENCE NO. | REFERENCE NO. | | | |
| | 23410-42701 23410-42711 23410-42721 23410-42202 | 23040-42200 23040-42202 23040-42210 | P 43171 | B 51102 | LSF 51102 LSX 51102 LFX 51102 MD050009 MD103648 21131-42001 | | | |
| | | | | | | | | 43 |
| D4BH 2476 cc 4 cyl.  Surface Treatment Tin Coated Bore Clearance MRC: 0.030 mm MP: 18.00 mm | \varnothing 91.10 -2.7 CD 48.7 TL 88.7 | 1 - 2.5 HK 1 - 2.0 HK 1 - 4.0 | \varnothing 29.000 TL 75.00  | | TL 165.0 OD 94.1 FT 2.0 FD 98.1 | 164.5 94.2 | TEIKIN NO. LKFX 51606AG LKSX 51606AG LKSF 51606AG | |
| | TEIKIN NO. | TEIKIN NO. | TEIKIN NO. | TEIKIN NO. | TEIKIN NO. | | | |
| | REFERENCE NO. | REFERENCE NO. | REFERENCE NO. | REFERENCE NO. | REFERENCE NO. | | | |
| | 23410-42500(L/R) 23410-42520 23411-42600 23411-42630 | 23040-42510/20/21 23040-42530/50/51 | P 43171 | B 51102 | LFX 51102 LSX 51102 LSF 51102 MD050009 23517-42001 21131-42001 | | | |
| | | | | | | | | 44 |

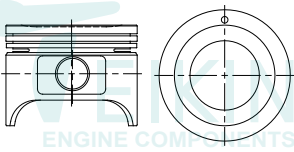
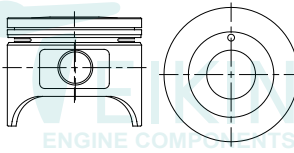
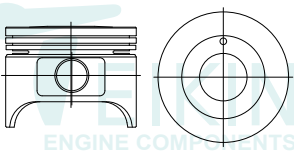
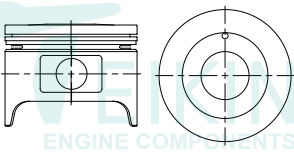

| ENGINE TYPE | PISTON | PISTON RING | PISTON PIN | PIN BUSHING | LINER | | | LINER KIT SET |
|---|--|--|---|-------------------------------------|---|----------------|---|---------------|
| | | | | | FLANGED | NO FLANGE | | |
| D4AE 3298 cc 4 cyl.  Surface Treatment Bore Clearance Tin Coated MRC: 0.080 mm MP: 26.50 mm | \emptyset 100.00 -17.4 CD 60.6 TL 110.6 | 1 - 3.0 FK 1 - 2.0 1 - 4.0 | \emptyset 34.000 TL 83.50  | | TL 191.0 OD 104.0 FT 5.0 FD 109.0 | 191.0 104.0 | TEIKIN NO. LKSF 51112 LKXS 51112 LKSF 51112A LKXS 51112A | |
| | TEIKIN NO. 51112 51112A | TEIKIN NO. R 51112 | TEIKIN NO. P 39138 | TEIKIN NO. B 51112 | TEIKIN NO. LSF 51112 LSX 51112 | | | |
| | REFERENCE NO. 23410-41410 23411-41410 23410-41430 23411-41700 | REFERENCE NO. 23040-41400 23040-41410 | REFERENCE NO. 23517-41310 | REFERENCE NO. 21311-41300 | | | | |
| | 45 | | | | | | | |
| D4AF 4 cyl. K-1 H-250 CHORUS  Surface Treatment Bore Clearance Tin Coated MRC: 0.060 mm MP: 27.00 mm | \emptyset 104.00 -19.0 CD 60.7 TL 110.7 | 1 - 3.0 HK 1 - 2.0 1 - 4.0 | \emptyset 34.000 TL 83.50  | | TL 192.0 OD 107.0 FT 4.0 FD 113.0 | 192.0 107.0 | TEIKIN NO. LKSF 51103 LKXS 51103 LKSF 51103A LKXS 51103A | |
| | TEIKIN NO. 51103 51103A | TEIKIN NO. R 51103 | TEIKIN NO. P 39138 | TEIKIN NO. B 51112 | TEIKIN NO. LSF 51103 LSX 51103 | | | |
| | REFERENCE NO. 23410-41210 | REFERENCE NO. 23040-41200 23040-46020 | REFERENCE NO. 23517-41310 | REFERENCE NO. 21131-41200 | | | | |
| | 46 | | | | | | | |
| D4AF-III 3568 cc 4 cyl.  Surface Treatment Bore Clearance Tin Coated MRC: 0.060 mm MP: 24.00 mm | \emptyset 104.00 -19.0 CD 60.7 TL 110.7 | 1 - 3.0 HK 1 - 2.0 1 - 4.0 | \emptyset 34.000 TL 84.00  | | TL 192.0 OD 107.0 FT 4.0 FD 113.0 | 192.0 107.0 | TEIKIN NO. LKXS 51607A LKSF 51607A | |
| | TEIKIN NO. 51607A | TEIKIN NO. R 51103 | TEIKIN NO. P 43683 | TEIKIN NO. B 51112 | TEIKIN NO. LSX 51103 LSF 51103 | | | |
| | REFERENCE NO. 23410-41200 23411-41200 | REFERENCE NO. 23040-41200 23040-46020 | REFERENCE NO. 23517-41310 | REFERENCE NO. 21131-41200 | | | | |
| | 47 | | | | | | | |
| D4DA 3907 cc 4 cyl.  Surface Treatment Bore Clearance Tin Coated MRC: 0.090 mm MP: 27.80 mm | \emptyset 104.00 -19.8 CD 62.2 TL 112.2 | 1 - 3.0 FK 1 - 2.0 1 - 4.0 | \emptyset 36.000 TL 88.00  | | TL 200.0 OD 108.0 FT 4.0 FD 113.0 | 200.0 108.0 | TEIKIN NO. LKSF 51602AG LKXS 51602AG | |
| | TEIKIN NO. 51602AG | TEIKIN NO. R 51602 | TEIKIN NO. P 43608 | TEIKIN NO. B 51602 | TEIKIN NO. LSF 51602 LSX 51602 | | | |
| | REFERENCE NO. 23411-45000 23410-45000 | REFERENCE NO. 23040-45010 | REFERENCE NO. 23315-45900 | REFERENCE NO. 21100-45000 | | | | |
| | 48 | | | | | | | |

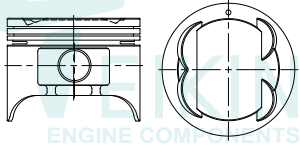
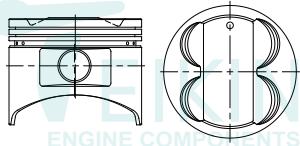
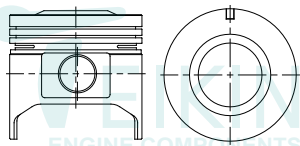
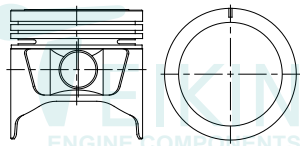
H

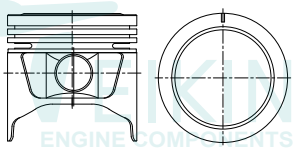
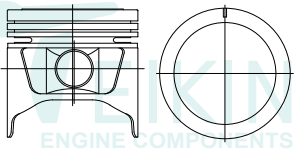
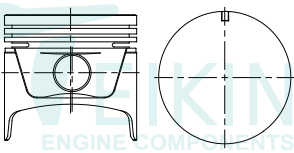
| ENGINE TYPE | PISTON | PISTON RING | PISTON PIN | PIN BUSHING | LINER | | LINER KIT SET |
|---|--|------------------------|---------------------------------|-------------|---------|--|---------------|
| | | | | | FLANGED | | |
| 4XC1 1471 cc 4 cyl.  ENGINE COMPONENTS | \varnothing 77.00 -0.9 CD 28.5 TL 59.0 | 2 - 1.2 1 - 2.8 | \varnothing 18.00 TL 63.00 | | | | TEIKIN NO. |
| | TEIKIN NO. | TEIKIN NO. | | | | | |
| | 39603 (39205) | P 39210 | | | | | |
| | REFERENCE NO. 8-94162-766-2 8-94162-766-0 | | | | | | |
| Surface Treatment Tin Coated | Bore Clearance MRC: 0.020 mm MP: 13.00 mm | | | | | | 1 |
| 4XC1-II 1471 cc 4 cyl.  ENGINE COMPONENTS | \varnothing 77.00 +0.5 CD 28.5 TL 62.5 | 1 - 1.5 1 - 2.8 | \varnothing 18.00 TL 62.70 | | | | TEIKIN NO. |
| | TEIKIN NO. | TEIKIN NO. | | | | | |
| | 39650 | P 39650 | | | | | |
| | REFERENCE NO. 8-94425-275-0 8-94460-838-2 8-94251-076-1 8-94141-420-0 | | | | | | |
| Surface Treatment Tin Coated | Bore Clearance MRC: 0.030 mm MP: 17.00 mm | | | | | | 2 |
| 4XC1-III 1471 cc 4 cyl.  ENGINE COMPONENTS | \varnothing 77.00 +0.5 CD 28.5 TL 59.5 | 2 - 1.2 1 - 2.8 | \varnothing 18.00 TL 65.00 | | | | TEIKIN NO. |
| | TEIKIN NO. | TEIKIN NO. | | | | | |
| | 39652 | P 39652 | | | | | |
| | REFERENCE NO. 8-94411-975-0 | | | | | | |
| Surface Treatment Tin Coated | Bore Clearance MRC: - mm MP: - mm | | | | | | 3 |
| 4XC1-IV 1471 cc 4 cyl.  ENGINE COMPONENTS | \varnothing 77.00 +0.5 CD 28.5 TL 59.5 | 1 - 1.5 1 - 2.8 | \varnothing 18.00 TL 61.00 | | | | TEIKIN NO. |
| | TEIKIN NO. | TEIKIN NO. | | | | | |
| | 39659 | P 43187 | | | | | |
| | REFERENCE NO. 8-94141-426-0 8-94425-275-0 8-94460-838-2 8-94251-076-1 | | | | | | |
| Surface Treatment Tin Coated | Bore Clearance MRC: 0.030 mm MP: 16.75 mm | | | | | | 4 |

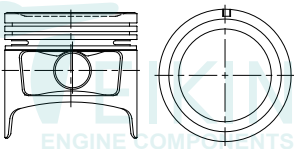
| ENGINE TYPE | PISTON | PISTON RING | PISTON PIN | PIN BUSHING | LINER | | LINER KIT SET |
|---|--|--------------------|--------------------------------|-------------|---------|-----------|---------------|
| | | | | | FLANGED | NO FLANGE | |
| 4XE1V 1588 cc SOHC 12 V STYLUS 1991-93 4 cyl. | \emptyset 80.00 -1.05 CD 28.5 TL 61.9 | 2 - 1.2 1 - 3.0 | \emptyset 18.000 TL 63.00 | | | | TEIKIN NO. |
|  | TEIKIN NO. | | TEIKIN NO. | | | | |
| | 39210 | | P 39210 | | | | |
| Surface Treatment Bore Clearance None MRC: 0.030 mm MP: 18.50 mm | REFERENCE NO. | | | | | | |
| 4XE1W 1588 cc DOHC 16 V IMPULSE 1990-91 I-MARK 1989, STYLUS 1991 4 cyl. | \emptyset 80.00 +0.7 CD 28.4 TL 64.7 | 2 - 1.2 1 - 3.0 | \emptyset 18.000 TL 66.00 | | | | TEIKIN NO. |
|  | TEIKIN NO. | | TEIKIN NO. | | | | |
| | 39209 | | P 39209 | | | | |
| Surface Treatment Bore Clearance Moly Skirt MRC: 0.030 mm MP: 20.50 mm | REFERENCE NO. | | | | | | |
| 4ZA1 1584 cc 4 cyl. | \emptyset 82.00 +2.4 CD 37.0 TL 80.4 | 2 - 1.5 1 - 4.0 | \emptyset 22.000 TL 66.00 | | | | TEIKIN NO. |
|  | TEIKIN NO. | | TEIKIN NO. | | | | |
| | 39605 (39214) | | P 39104 | | | | |
| Surface Treatment Bore Clearance Tin Coated MRC: 0.030 mm MP: 24.00 mm | REFERENCE NO. | | | | | | |
| G161Z 1584 cc KB20, GEMINI COUPE GEMINI LT-MINX LS, LT, LD, ELF-TRK FASTER (G.M) 4 cyl. | \emptyset 82.00 +0.4 CD 37.0 TL 80.5 | 2 - 2.0 1 - 4.0 | \emptyset 22.000 TL 66.00 | | | | TEIKIN NO. |
|  | TEIKIN NO. | | TEIKIN NO. | | | | |
| | 39104 | | P 39104 | | | | |
| Surface Treatment Bore Clearance Tin Coated MRC: 0.030 mm MP: 25.00 mm | REFERENCE NO. | | | | | | |

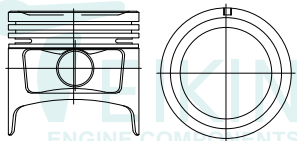
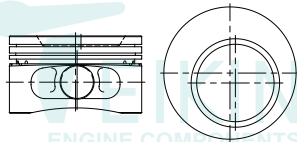

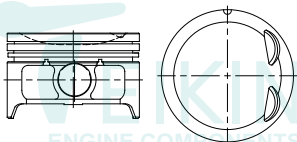

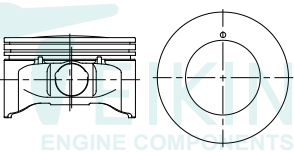
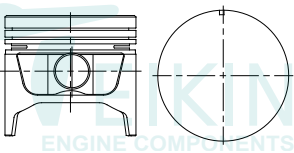
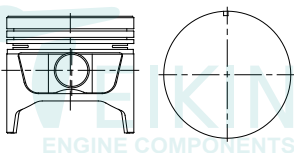
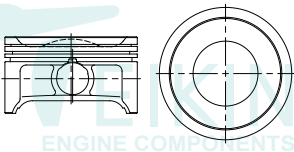

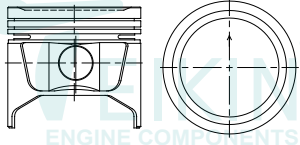
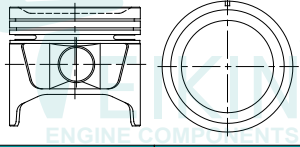
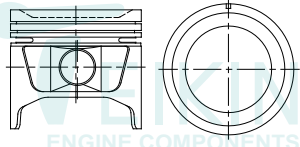
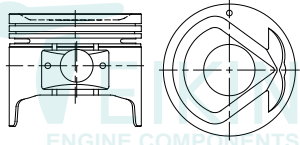

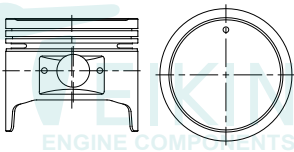
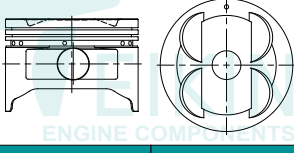
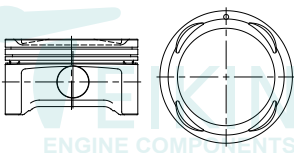
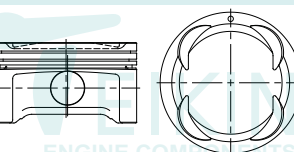
| ENGINE TYPE | PISTON | PISTON RING | PISTON PIN | PIN BUSHING | LINER | | LINER KIT SET |
|---|---|------------------------|---|-------------|---------|-----------|---|
| | | | | | FLANGED | NO FLANGE | |
| G161ZB-II 1584 cc 4 cyl.  | \varnothing 82.00 +0.8 CD 37.0 TL 80.9 | 2 - 2.0 1 - 4.0 | \varnothing 22.000 TL 66.00 | | | | TEIKIN NO. 9 |
| | TEIKIN NO. 39236 | TEIKIN NO. P 39104 | | | | | |
| | REFERENCE NO. 8-94218-808-0 8-94220-636-0 | | | | | | |
| | Surface Treatment Bore Clearance Tin Coated MRC: 0.030 mm MP: 25.00 mm | | | | | | |
| G161Z-II 1584 cc 4 cyl.  | \varnothing 82.00 +0.5 CD 37.0 TL 80.5 | 2 - 1.5 1 - 4.0 | \varnothing 22.000 TL 69.50 | | | | TEIKIN NO. 10 |
| | TEIKIN NO. 39628 (39225) | TEIKIN NO. P 46202 | | | | | |
| | REFERENCE NO. 8-94244-402-0 | | | | | | |
| | Surface Treatment Bore Clearance Tin Coated MRC: 0.030 mm MP: 25.00 mm | | | | | | |
| G180SR 1817 cc 4 cyl.  | \varnothing 84.00 CD 36.8 TL 79.8 | 2 - 2.0 1 - 4.0 | \varnothing 22.000 TL 66.00  | | | | TEIKIN NO. 11 |
| | TEIKIN NO. 39208 | TEIKIN NO. P 39104 | | | | | |
| | REFERENCE NO. 9-12411-670-0 9-12411-622-0 | | | | | | |
| | Surface Treatment Bore Clearance None MRC: 0.030 mm MP: 25.00 mm | | | | | | |
| G180Z 1817 cc 4 cyl.  | \varnothing 84.00 -2.4 CD 36.8 TL 79.8 | 2 - 2.0 1 - 4.0 | \varnothing 22.000 TL 66.00 | | | | TEIKIN NO. 12 |
| | TEIKIN NO. 39110 | TEIKIN NO. P 39104 | | | | | |
| | REFERENCE NO. 8-94201-040-0 8-94201-607-0 8-94208-205-0 | | | | | | |
| | Surface Treatment Bore Clearance Tin Coated MRC: 0.030 mm MP: 25.00 mm | | | | | | |

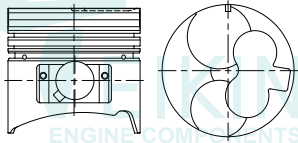

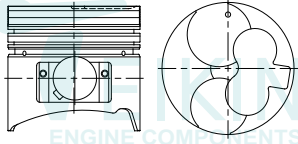

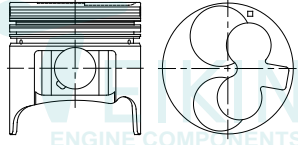

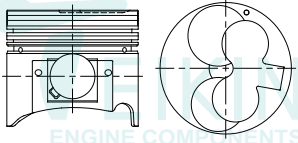

| ENGINE TYPE | PISTON | PISTON RING | PISTON PIN | PIN BUSHING | LINER | | LINER KIT SET |
|---|---|--------------------|--------------------------------|-------------|---------|-----------|---------------|
| | | | | | FLANGED | NO FLANGE | |
| G180Z-II 1817 cc AUTOM - CAMION SOHC 1981-85 4 cyl. | \emptyset 84.00 -0.8 CD 37.0 TL 80.0 | 2 - 2.0 1 - 4.0 | \emptyset 22.000 TL 66.00 | | | | TEIKIN NO. |
|  | TEIKIN NO. 39654 | | TEIKIN NO. P 39104 | | | | |
| Surface Treatment Bore Clearance Tin Coated MRC: 0.030 mm MP: 25.00 mm | REFERENCE NO. 8-94215-088-0 | | | | | | 13 |
| LUV 2200 cc 4 cyl. | \emptyset 86.00 -7.1 CD 30.0 TL 50.1 | 2 - 1.5 1 - 3.0 | \emptyset 21.000 TL 61.50 | | | | TEIKIN NO. |
|  | TEIKIN NO. 39233 | | TEIKIN NO. P 56104 | | | | |
| Surface Treatment Bore Clearance None MRC: 0.030 mm MP: 6.50 mm | REFERENCE NO. 8-92062-633-0 | | | | | | 14 |
| X20SE 1998 cc DAEWOO NUBIRA 1999-2002 DOHC 16V 4 cyl. | \emptyset 86.00 -6.5 CD 30.4 TL 55.4 | 2 - 1.5 1 - 3.0 | \emptyset 21.000 TL 61.50 | | | | TEIKIN NO. |
|  | TEIKIN NO. 39229 | | TEIKIN NO. P 56104 | | | | |
| Surface Treatment Bore Clearance Tin Coated MRC: 0.030 mm MP: 10.00 mm | REFERENCE NO. 9-05010-58 MAHLE: 011 03 00 | | | | | | 15 |
| X22SE 2198 cc DOHC 16 V AMIGO, RODEO 1998-00 4 cyl. | \emptyset 86.00 -7.5 CD 30.4 TL 55.5 | 2 - 1.5 1 - 3.0 | \emptyset 21.000 TL 61.50 | | | | TEIKIN NO. |
|  | TEIKIN NO. 39211 | | TEIKIN NO. P 56104 | | | | |
| Surface Treatment Bore Clearance Tin Coated MRC: 0.030 mm MP: 12.00 mm | REFERENCE NO. 8-92062-910-0 | | | | | | 16 |

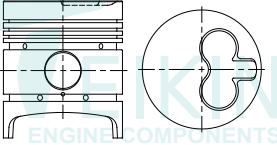
| ENGINE TYPE | PISTON | PISTON RING | PISTON PIN | PIN BUSHING | LINER | | LINER KIT SET |
|---|--|-------------------------------|---|-------------|---------|-----------|---------------|
| | | | | | FLANGED | NO FLANGE | |
| X22SE-II RODEO 4 cyl. | \varnothing 86.00 +1.2 CD 27.6 TL 53.7 | 1 - 1.2 1 - 1.5 1 - 2.5 | \varnothing 21.000 TL 61.50 | | | | TEIKIN NO. |
|  | TEIKIN NO. 39230 | | TEIKIN NO. P 56104 | | | | |
| Surface Treatment Tin Coated | Bore Clearance MRC: 0.030 mm MP: 11.00 mm | | REFERENCE NO. 8-92064-692-0 8-92064-693-0 | | | | 17 |
| G200Z 1979 4 cyl. | \varnothing 87.00 CD 37.0 TL 79.9 | 2 - 1.5 1 - 4.0 | \varnothing 22.000 TL 79.00 | | | | TEIKIN NO. |
|  | TEIKIN NO. 39119 | | TEIKIN NO. P 43153 | | | | |
| Surface Treatment Tin Coated | Bore Clearance MRC: 0.030 mm MP: 24.50 mm | | REFERENCE NO. 8-94237-469-1 | | | | 18 |
| G200Z-II 1949 cc 4 cyl. | \varnothing 87.00 CD 37.0 TL 80.0 | 2 - 2.0 1 - 4.0 | \varnothing 22.000 TL 79.00 | | | | TEIKIN NO. |
|  | TEIKIN NO. 39226 (39610) | | TEIKIN NO. P 43153 | | | | |
| Surface Treatment Tin Coated | Bore Clearance MRC: 0.030 mm MP: 24.50 mm | | REFERENCE NO. 8-94213-831-0 8-94271-840-0 8-94271-890-0 | | | | 19 |
| DIMAX 2.4L 4 cyl. | \varnothing 87.50 -6.4 CD 27.3 TL 50.3 | 1 - 1.2 1 - 1.5 1 - 2.5 | \varnothing 21.000 TL 61.50 | | | | TEIKIN NO. |
|  | TEIKIN NO. 39235 | | TEIKIN NO. P 56104 | | | | |
| Surface Treatment Tin Coated | Bore Clearance MRC: 0.030 mm MP: 10.00 mm | | REFERENCE NO. 8-93292-774-0 8-93325-189-0 93325556 | | | | 20 |

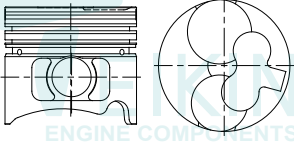

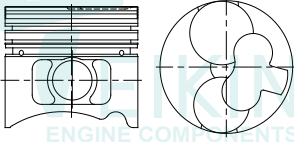

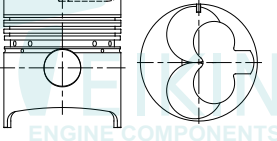

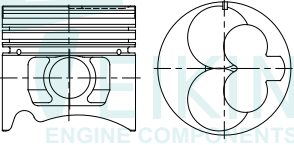

| ENGINE TYPE | PISTON | PISTON RING | PISTON PIN | PIN BUSHING | LINER | | LINER KIT SET |
|--|---|------------------------------|--------------------------------|-------------|---------|-----------|---------------|
| | | | | | FLANGED | NO FLANGE | |
| 4ZC1 1994 cc WFR 2.01 1986-ON 4 cyl. | \emptyset 88.00 -2.1 CD 37.0 TL 80.0 | 2 - 1.5 1 - 4.0 | \emptyset 22.000 TL 69.50 | | | | TEIKIN NO. |
|  | TEIKIN NO. 39175 | TEIKIN NO. P 46202 | | | | | |
| Surface Treatment Bore Clearance None MRC: 0.030 mm MP: 23.50 mm | REFERENCE NO. 8-94175-087-2 8-94224-314-0 | | | | | | |
| | | | | | | | |
| 4ZD1 2254 cc PICK UP 1986 - 87 TROOPER II 1986 - 87 AMIGO 1989 - 93 IMPULSE 1988 - 89 4 cyl. | \emptyset 89.30 -4.2 CD 39.0 TL 81.0 | 2 - 1.5 1 - 4.0 | \emptyset 23.000 TL 80.00 | | | | TEIKIN NO. |
|  | TEIKIN NO. 39176 | TEIKIN NO. P 39176 | | | | | |
| Surface Treatment Bore Clearance Tin Coated MRC: 0.026 mm MP: 23.00 mm | REFERENCE NO. 8-94438-625-2 8-94439-301-2 8-94136-777-3 | | | | | | |
| | | | | | | | |
| 4ZD1-II 2254 cc 4 cyl. | \emptyset 89.30 -5.2 CD 39.0 TL 81.0 | 2 - 1.5 1 - 4.0 | \emptyset 23.000 TL 80.00 | | | | TEIKIN NO. |
|  | TEIKIN NO. 39228 | TEIKIN NO. P 39176 | | | | | |
| Surface Treatment Bore Clearance None MRC: 0.030 mm MP: 23.00 mm | REFERENCE NO. 8-94156-657-0 8-94413-459-0 | | | | | | |
| | | | | | | | |
| 4ZE1 2559 cc C & FI SOHC 4 PICKUP, AMIGO, RODEO 1994-96 4 cyl. | \emptyset 92.60 -4.6 CD 36.5 TL 79.1 | 2 - 1.5 1 - 4.0 | \emptyset 23.000 TL 80.00 | | | | TEIKIN NO. |
|  | TEIKIN NO. 39185 | TEIKIN NO. P 39176 | | | | | |
| Surface Treatment Bore Clearance Tin Coated MRC: 0.030 mm MP: 24.00 mm | REFERENCE NO. 8-97037-801-1 | | | | | | |
| | | | | | | | |

| ENGINE TYPE | PISTON | PISTON RING | PISTON PIN | PIN BUSHING | LINER | | LINER KIT SET |
|---|--|--------------------|-----------------------------|-------------|---------|-----------|---------------|
| | | | | | FLANGED | NO FLANGE | |
| 4ZE1-II 2559 cc 4 cyl.  TEIKIN ENGINE COMPONENTS Surface Treatment Tin Coated Bore Clearance MRC: 0.030 mm MP: 24.50 mm | Ø 92.60 -1.3 CD 36.5 TL 78.9 | 2 - 1.5 1 - 4.0 | Ø 23.000 TL 80.00 | | | | TEIKIN NO. |
| | TEIKIN NO. | | TEIKIN NO. | | | | |
| | 39604 (39212) | | P 39176 | | | | |
| | REFERENCE NO. | | | | | | |
| | 8-94163-189-2 | | | | | | |
| | | | | | | | 25 |
| 6VD1 3165 cc DOHC V6 TROOPER, RODEO 1992-96  TEIKIN ENGINE COMPONENTS Surface Treatment Tin Coated Bore Clearance MRC: 0.020 mm MP: 19.50 mm | Ø 93.40 -0.7 CD 31.8 TL 65.2 | 2 - 1.5 1 - 4.0 | Ø 22.000 TL 66.00 | | | | TEIKIN NO. |
| | TEIKIN NO. | | TEIKIN NO. | | | | |
| | 39186 | | P 39104 | | | | |
| | REFERENCE NO. | | | | | | |
| | 8-94374-965-1 8-12211-034-1 | | | | | | |
| | | | | | | | 26 |
| 6VE1 DIMAX 3.5L 6 cyl.  TEIKIN ENGINE COMPONENTS Surface Treatment Tin Coated Bore Clearance MRC: 0.030 mm MP: 7.90 mm | Ø 93.40 -4.2 CD 29.7 TL 52.7 | 2 - 1.2 1 - 2.0 | Ø 22.000 TL 66.00 | | | | TEIKIN NO. |
| | TEIKIN NO. | | TEIKIN NO. | | | | |
| | 39234 | | P 39104 | | | | |
| | REFERENCE NO. | | | | | | |
| | 8-97358-040-0 | | | | | | |
| | | | | | | | 27 |
| 6VE1-II 6 cyl.  TEIKIN ENGINE COMPONENTS Surface Treatment Tin Coated Bore Clearance MRC: 0.030 mm MP: 7.90 mm | Ø 93.40 -3.0 CD 29.7 TL 52.7 | 2 - 1.5 1 - 3.0 | Ø 22.000 TL 66.00 | | | | TEIKIN NO. |
| | TEIKIN NO. | | TEIKIN NO. | | | | |
| | 39673 | | P 39104 | | | | |
| | REFERENCE NO. | | | | | | |
| | 8-97136-315-3 | | | | | | |
| | | | | | | | 28 |

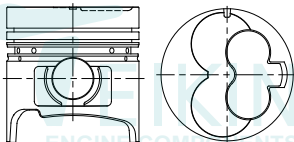
| ENGINE TYPE | PISTON | PISTON RING | PISTON PIN | PIN BUSHING | LINER | | | LINER KIT SET |
|---|---|---|---|------------------------------|---|---------------|---|---------------|
| | | | | | FLANGED | NO FLANGE | | |
| 4EC1 OLD 1487 cc 4 cyl.  | \emptyset 76.00 -1.5 CD 41.7 TL 71.8 | 1 - 2.0 1 - 1.5 1 - 3.0 | \emptyset 22.000 TL 60.00  | | TL 145.0 OD 80.0 FT 5.0 FD 84.0 | 140.0 80.0 | TEIKIN NO. LKSF 39170 LKSF 39170 LKSF 39170A LKSF 39170A | |
| | TEIKIN NO. 39170 39170A | TEIKIN NO. R 39170 | TEIKIN NO. P 34102 | TEIKIN NO. B 39170 | TEIKIN NO. LSF 39170 LSX 39170 | | | |
| | REFERENCE NO. 8-94129-828-0 8-94129-828-1 | REFERENCE NO. 8-94144-187-0 8-94332-767-1 8-94342-490-0 | REFERENCE NO. 8-94251-216-1 | REFERENCE NO. | | | | |
| | Surface Treatment Bore Clearance Tin Coated MRC: 0.030 mm MP: 14.50 mm | | | | | | | |
| | 30 | | | | | | | |
| 4EC1 TURBO 1487 cc 4 cyl.  | \emptyset 76.00 -1.5 CD 41.7 TL 71.7 | 1 - 2.0 1 - 1.5 1 - 3.0 | \emptyset 25.000 TL 60.00  | | TL 145.0 OD 80.0 FT 5.0 FD 84.0 | 140.0 80.0 | TEIKIN NO. LKSF 39179 LKSF 39179 LKSF 39179A LKSF 39179A | |
| | TEIKIN NO. 39179 39179A | TEIKIN NO. R 39170 | TEIKIN NO. P 39179 | TEIKIN NO. B 39179 | TEIKIN NO. LSF 39170 LSX 39170 | | | |
| | REFERENCE NO. 8-94129-431-0 8-94149-276-4 | REFERENCE NO. 8-94144-187-0 8-94332-767-1 8-94342-490-0 | REFERENCE NO. 5-12251-007-0 8-94114-054-0 | REFERENCE NO. | | | | |
| | Surface Treatment Bore Clearance Tin Coated MRC: 0.030 mm MP: 14.00 mm | | | | | | | |
| | 31 | | | | | | | |
| 4EE1 1686 cc CORSA 1.7L 4 cyl.  | \emptyset 79.00 -1.7 CD 39.7 TL 79.7 | 1 - 2.0 1 - 1.5 1 - 3.0 | \emptyset 25.000 TL 60.00  | | TL 144.0 OD 83.0 FT 2.0 FD 87.0 | 144.0 83.0 | TEIKIN NO. LKSF 39668A LKSF 39668A | |
| | TEIKIN NO. 39668A | TEIKIN NO. R 39189 | TEIKIN NO. P 39668 | TEIKIN NO. B 39179 | TEIKIN NO. LSF 39189 LSX 39189 | | | |
| | REFERENCE NO. 8-97129-437-0 8-97129-437-1 8-97129-437-2 | REFERENCE NO. 8-94381-709-0 8-94381-709-1 | REFERENCE NO. 5-12251-007-0 8-94114-054-0 | REFERENCE NO. | | | | |
| | Surface Treatment Bore Clearance Tin Coated MRC: 0.020 mm MP: 23.00 mm | | | | | | | |
| | 32 | | | | | | | |
| 4EE1-T 1686 cc 4 cyl.  | \emptyset 79.00 -1.5 CD 39.7 TL 69.8 | 1 - 2.0 1 - 1.5 1 - 3.0 | \emptyset 27.000 TL 64.00  | | TL 144.0 OD 83.0 FT 2.0 FD 87.0 | 144.0 83.0 | TEIKIN NO. LKSF 39189 LKSF 39189 LKSF 39189A LKSF 39189A | |
| | TEIKIN NO. 39189 39189A | TEIKIN NO. R 39189 | TEIKIN NO. P 39189 | TEIKIN NO. B 39189 | TEIKIN NO. LSF 39189 LSX 39189 | | | |
| | REFERENCE NO. 8-97043-772-0 8-97043-773-0 | REFERENCE NO. 8-94381-709-0 8-94381-709-1 | REFERENCE NO. 8-94369-904-0 | REFERENCE NO. | | | | |
| | Surface Treatment Bore Clearance Tin Coated MRC: 0.030 mm MP: 13.00 mm | | | | | | | |
| | 33 | | | | | | | |

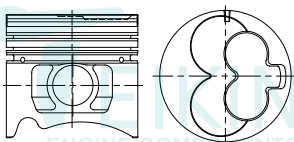
| ENGINE TYPE | PISTON | PISTON RING | PISTON PIN | PIN BUSHING | LINER | | LINER KIT SET |
|---|--|--|---|---|--|---------------|---|
| | | | | | FLANGED | NO FLANGE | |
| C-221-II 2207 cc 4 cyl.  | \varnothing 83.00 -3.0 CD 48.5 TL 95.5 | 3 - 2.0 2 - 5.0 | \varnothing 25.000 TL 72.50  | | TL 174.0 OD 86.0 FT 1.4 FD 92.0 | | TEIKIN NO. LKCF 39620 |
| | TEIKIN NO. 39620 (39216) | TEIKIN NO. R 39620 | TEIKIN NO. P 39620 | TEIKIN NO. B 39620 | TEIKIN NO. LCF 39620 | | |
| | REFERENCE NO. 9-12111-646-0 5-12111-065-0 | REFERENCE NO. 5-12121-013-0 5-12121-014-0 5-12121-015-0 9-12181-122-0 | | REFERENCE NO. 9-12251-038-0 9-12251-048-0 9-12251-061-0 | REFERENCE NO. 9-11261-253-0 9-11261-253-1 | | |
| | Surface Treatment Bore Clearance Tin Coated MRC: 0.070 mm MP: 10.00 mm | | | | | | |
| 34 | | | | | | | |
| 4FB1 1817 cc 4 cyl.  | \varnothing 84.00 -1.9 CD 44.7 TL 74.7 | 1 - 2.5 1 - 2.0 1 - 4.0 | \varnothing 25.000 TL 67.00  | | TL 172.0 OD 88.0 FT 4.0 FD 92.0 | 150.0 88.0 | TEIKIN NO. LKSF 39183 LKSF 39183 LKSF 39183A LKSF 39183A |
| | TEIKIN NO. 39183 39183A | TEIKIN NO. R 39157 | TEIKIN NO. P 39157 | TEIKIN NO. B 39157 | TEIKIN NO. LSF 39157 LSX 39157 | | |
| | REFERENCE NO. 8-94228-886-2 8-94201-492-0 8-94235-962-0 | REFERENCE NO. 8-94139-973-0 8-94224-221-0 | | REFERENCE NO. 5-12251-007-0 | REFERENCE NO. 5-11261-119-0 | | |
| | Surface Treatment Bore Clearance Tin Coated MRC: 0.030 mm MP: 12.00 mm | | | | | | |
| 35 | | | | | | | |
| 4FC1 1995 cc 4 cyl.  | \varnothing 84.00 -1.8 CD 46.7 TL 76.7 | 1 - 2.5 1 - 2.0 1 - 4.0 | \varnothing 25.000 TL 67.00  | | TL 172.0 OD 88.0 FT 4.0 FD 92.0 | 150.0 88.0 | TEIKIN NO. LKSF 39157 LKSF 39157 LKSF 39157A LKSF 39157A |
| | TEIKIN NO. 39157 39157A | TEIKIN NO. R 39157 | TEIKIN NO. P 39157 | TEIKIN NO. B 39157 | TEIKIN NO. LSF 39157 LSX 39157 | | |
| | REFERENCE NO. 8-94111-655-1 8-94228-887-0 8-94228-887-1 | REFERENCE NO. 8-94224-221-0 8-94139-973-0 | | REFERENCE NO. 5-12251-007-0 | REFERENCE NO. 5-11261-119-0 | | |
| | Surface Treatment Bore Clearance Tin Coated MRC: 0.030 mm MP: 12.40 mm | | | | | | |
| 36 | | | | | | | |
| C-190 2369 cc C-240 NEW 1971 4 cyl.  | \varnothing 86.00 -2.7 CD 51.6 TL 95.6 | 3 - 2.0 1 - 5.0 | \varnothing 27.000 TL 72.00  | | TL 178.5 OD 88.0 FT 0.9 FD 94.0 | | TEIKIN NO. LKCF 39127 LKSF 39127 LKCF 39127A LKSF 39127A |
| | TEIKIN NO. 39127 39127A | TEIKIN NO. R 39125 | TEIKIN NO. P 39125 | TEIKIN NO. B 39125 | TEIKIN NO. LCF 39125 LSF 39125 | | |
| | REFERENCE NO. 5-12111-119-0 5-12111-203-0 5-12111-137-0 5-12111-202-0 | REFERENCE NO. 5-12121-007-0 5-12181-027-0 5-12181-028-0 9-12181-603-0 | | REFERENCE NO. 9-12251-062-0 | REFERENCE NO. 9-11261-230-0 9-11261-230-1 | | |
| | Surface Treatment Bore Clearance Tin Coated MRC: 0.070 mm MP: 22.30 mm | | | | | | |
| 37 | | | | | | | |

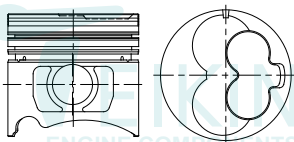
| ENGINE TYPE | PISTON | PISTON RING | PISTON PIN | PIN BUSHING | LINER | | LINER KIT SET |
|---|---|--|---|--|--|-----------|---|
| | | | | | FLANGED | NO FLANGE | |
| C-190-3R 1951 cc C-240 4 cyl. | \emptyset 86.00 -2.0 CD 51.5 TL 96.6 | 1 - 2.5 1 - 2.0 1 - 5.0 | \emptyset 27.000 TL 68.00 | | TL 163.3 OD 88.0 FT 0.9 FD 94.0 * DIMENSION IS FOR LCF | | TEIKIN NO. LKCF 39128 LKSF 39128 LKCF 39128A LKSF 39128A |
| | TEIKIN NO. 39128 39128A | TEIKIN NO. R 39128 | TEIKIN NO. P 39130 | TEIKIN NO. B 39128 | TEIKIN NO. LCF 39128 LSF 39128 | | |
| | REFERENCE NO. 5-12111-225-0 5-12111-226-0 | REFERENCE NO. 5-12121-021-0 8-94104-949-0 | REFERENCE NO. 5-12251-005-0 5-12251-007-0 9-12251-005-0 | REFERENCE NO. 9-11261-224-0 9-11261-224-1 | | | |
| | Surface Treatment Bore Clearance Tin Coated MRC: 0.070 mm MP: 23.00 mm | | | | | | |
| C-240 2369 cc 4 cyl. | \emptyset 86.00 -2.5 CD 51.5 TL 84.5 | 1 - 2.5 1 - 2.0 1 - 5.0 | \emptyset 27.000 TL 68.00 | | TL 178.5 OD 88.0 FT 0.9 FD 94.0 * DIMENSION IS FOR LCF | | TEIKIN NO. LKCF 39621 LKSF 39621 LKCF 39621A LKSF 39621A |
| | TEIKIN NO. 39621 39621A (39217) | TEIKIN NO. R 39128 | TEIKIN NO. P 39130 | TEIKIN NO. B 39128 | TEIKIN NO. LCF 39125 LSF 39125 | | |
| | REFERENCE NO. 8-94326-225-0 | REFERENCE NO. 5-12121-021-0 8-94104-949-0 | REFERENCE NO. 5-12251-005-0 5-12251-007-0 9-12251-005-0 | REFERENCE NO. 9-11261-230-0 9-11261-230-1 | | | |
| | Surface Treatment Bore Clearance Tin Coated MRC: 0.020 mm MP: 15.00 mm | | | | | | |
| C-240 OLD 2369 cc 4 cyl. | \emptyset 86.00 -3.0 CD 51.5 TL 95.4 | 3 - 2.0 1 - 5.0 | \emptyset 27.000 TL 72.00 | | TL 178.5 OD 88.0 FT 0.9 FD 94.0 * DIMENSION IS FOR LCF | | TEIKIN NO. LKCF 39125 LKSF 39125 LKCF 39125A LKSF 39125A |
| | TEIKIN NO. 39125 39125A | TEIKIN NO. R 39125 | TEIKIN NO. P 39125 | TEIKIN NO. B 39125 | TEIKIN NO. LCF 39125 LSF 39125 | | |
| | REFERENCE NO. 9-12111-813-0 5-12111-064-0 5-12411-064-0 | REFERENCE NO. 5-12121-007-0 5-12181-027-0 5-12181-028-0 9-12181-603-0 | REFERENCE NO. 9-12251-062-0 | REFERENCE NO. 9-11261-230-0 9-11261-230-1 | | | |
| | Surface Treatment Bore Clearance Tin Coated MRC: 0.070 mm MP: 24.00 mm | | | | | | |
| 4FD1 2189 cc 4 cyl. | \emptyset 88.00 -2.2 CD 46.7 TL 80.7 | 2 - 2.0 1 - 4.0 | \emptyset 27.000 TL 68.00 | | TL 169.0 OD 92.0 FT 4.0 FD 96.0 | | TEIKIN NO. LKSF 39159 LKXS 39159 LKSF 39159A LKXS 39159A |
| | TEIKIN NO. 39159 39159A | TEIKIN NO. R 39159 | TEIKIN NO. P 39130 | TEIKIN NO. B 39159 | TEIKIN NO. LSF 39159 LSX 39159 | | |
| | REFERENCE NO. 8-94105-454-0 | REFERENCE NO. 8-94250-730-0 | REFERENCE NO. 8-94247-838-0 | REFERENCE NO. 8-94286-454-0 | | | |
| | Surface Treatment Bore Clearance Tin Coated MRC: 0.030 mm MP: 12.00 mm | | | | | | |









| ENGINE TYPE | PISTON | PISTON RING | PISTON PIN | PIN BUSHING | LINER | | LINER KIT SET |
|--|---|--|---|---|---|-----------|---|
| | | | | | FLANGED | NO FLANGE | |
| C-223 2238 cc 4 cyl.  | \emptyset 88.00 -2.3 CD 47.6 TL 82.7 | 2 - 2.0 1 - 4.0 | \emptyset 27.000 TL 68.00  | | TL 163.0 OD 90.0 FT 0.9 FD 95.0 * DIMENSION IS FOR LCF | | TEIKIN NO. LKCF 39130 LKSF 39130 LKCF 39130A LKSF 39130A |
| | TEIKIN NO. 39130 39130A | TEIKIN NO. R 39130 | TEIKIN NO. P 39130 | TEIKIN NO. B 39128 | TEIKIN NO. LCF 39130 LSF 39130 | | |
| | REFERENCE NO. 8-94250-729-0 | REFERENCE NO. 8-94253-736-0 | | REFERENCE NO. 5-12251-005-0 5-12251-007-0 9-12251-005-0 | REFERENCE NO. 5-11261-015-0 5-11261-015-2 8-94169-883-1 | | |
| | Surface Treatment Bore Clearance Tin Coated MRC: 0.050 mm MP: 13.65 mm | | | | | | |
| C-223 OLD 2238 cc 4 cyl.  | \emptyset 88.00 -2.5 CD 47.5 TL 90.0 | 1 - 2.5 1 - 2.0 1 - 4.5 | \emptyset 27.000 TL 68.00  | | TL 163.0 OD 90.0 FT 0.9 FD 95.0 * DIMENSION IS FOR LCF | | TEIKIN NO. LKCF 39601 LKSF 39601 LKCF 39601A LKSF 39601A |
| | TEIKIN NO. 39601 39601A (39191) | TEIKIN NO. R 39601 | TEIKIN NO. P 39130 | TEIKIN NO. B 39128 | TEIKIN NO. LCF 39130 LSF 39130 | | |
| | REFERENCE NO. 5-12111-212-0 | REFERENCE NO. 5-12121-017-0 5-12121-024-0 | | REFERENCE NO. 5-12251-005-0 5-12251-007-0 9-12251-005-0 | REFERENCE NO. 5-11261-015-0 5-11261-015-2 8-94169-883-1 | | |
| | Surface Treatment Bore Clearance Tin Coated MRC: 0.100 mm MP: 21.00 mm | | | | | | |
| C-223-II 2238 cc 4 cyl.  | \emptyset 88.00 -3.45 CD 47.6 TL 82.7 | 2 - 2.0 1 - 4.0 | \emptyset 27.000 TL 68.00  | | | | TEIKIN NO. |
| | TEIKIN NO. 39218 39218A | | TEIKIN NO. P 39130 | | | | |
| | REFERENCE NO. | | | | | | |
| | Surface Treatment Bore Clearance Tin Coated MRC: 0.050 mm MP: 13.65 mm | | | | | | |
| C-223-T 2238 cc 4 cyl.  | \emptyset 88.00 -1.8 CD 47.6 TL 82.6 | 1 - 2.5 1 - 2.0 1 - 4.0 | \emptyset 29.000 TL 68.00  | | TL 163.0 OD 90.0 FT 0.9 FD 95.0 * DIMENSION IS FOR LCF | | TEIKIN NO. LKCF 39609 LKSF 39609 LKCF 39609A LKSF 39609A |
| | TEIKIN NO. 39609 39609A (39198) | TEIKIN NO. R 39609 | TEIKIN NO. P 39609 | TEIKIN NO. B 39609 | TEIKIN NO. LCF 39130 LSF 39130 | | |
| | REFERENCE NO. 8-94118-826-0 | REFERENCE NO. 8-94158-084-0 | | REFERENCE NO. | REFERENCE NO. 5-11261-015-0 5-11261-015-2 8-94169-883-1 | | |
| | Surface Treatment Bore Clearance Tin Coated MRC: 0.040 mm MP: 14.00 mm | | | | | | |

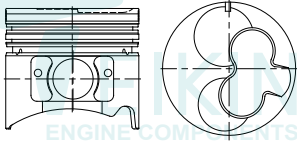

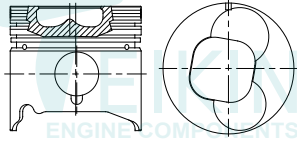

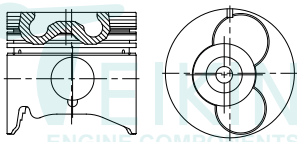

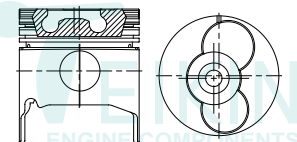

42

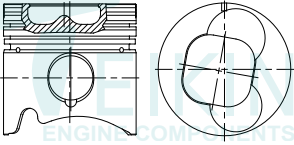

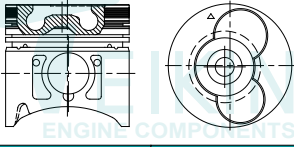

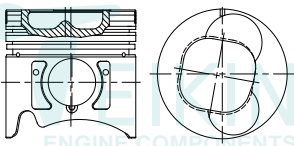

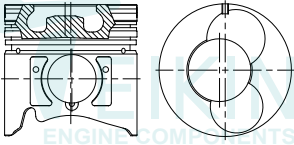

43

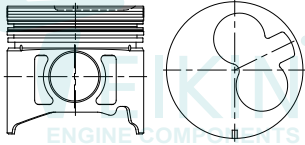
44

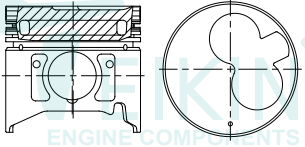
45

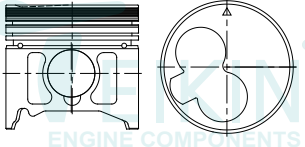
| ENGINE TYPE | PISTON | PISTON RING | PISTON PIN | PIN BUSHING | LINER | | LINER KIT SET |
|--|--|---|--|---|--|------------------------|---|
| | | | | | FLANGED | NO FLANGE | |
| 4FG1 2380 cc 4 cyl.  | \emptyset 89.30 -2.8 CD 47.2 TL 80.7 | 2 - 2.0 1 - 4.0 | \emptyset 27.00 TL 68.00  | | TL 194.5 OD 93.3 FT 4.0 FD 97.3 | 190.5 93.3 | TEIKIN NO. LKSF 39602 LKSF 39602A LKFX 39602 LKFX 39602A LKFX 39602A LKFX 39602A |
| | TEIKIN NO. 39602 39602A (39193) | TEIKIN NO. R 39602 | TEIKIN NO. P 39130 | TEIKIN NO. B 39159 | TEIKIN NO. LSF 39602 LSX 39602 LFX 39602 | | |
| | REFERENCE NO. 8-94454-813-0 8-97073-851-0 | REFERENCE NO. 8-94469-634-0 | REFERENCE NO. 8-94247-838-0 | REFERENCE NO. 8-94247-838-0 | REFERENCE NO. | | |
| | Surface Treatment Bore Clearance Tin Coated MRC: 0.030 mm MP: 16.00 mm | 46 | | | | | |
| 4JA1 2499 cc 4 cyl.  | \emptyset 93.00 -14.6 CD 47.8 TL 87.9 | 2 - 2.0 1 - 4.0 | \emptyset 31.00 TL 77.00  | | TL 156.0 OD 95.0 FT 0.9 FD 101.0 | * DIMENSION IS FOR LCF | TEIKIN NO. LKCF 39162 LKSF 39162 LKCF 39162A LKSF 31962A |
| | TEIKIN NO. 39162 39162A | TEIKIN NO. R 39162 | TEIKIN NO. P 39162 | TEIKIN NO. B 39162 | TEIKIN NO. LCF 39162 LSF 39162 | | |
| | REFERENCE NO. 8-94152-712-1 8-94369-281-0 | REFERENCE NO. 8-94247-867-0 8-94247-867-1 8-97319-087-0 | REFERENCE NO. 8-94247-968-0 8-94419-455-0 | REFERENCE NO. 8-94110-144-0 8-94462-130-0 8-97176-691-0 | REFERENCE NO. | | |
| | Surface Treatment Bore Clearance Tin Coated MRC: 0.030 mm MP: 16.00 mm | 47 | | | | | |
| 4JA1 LATE 2499 cc 4 cyl.  | \emptyset 93.00 -17.5 CD 47.8 TL 87.8 | 2 - 2.0 1 - 4.0 | \emptyset 31.00 TL 76.00  | | TL 156.0 OD 95.0 FT 0.9 FD 101.0 | * DIMENSION IS FOR LCF | TEIKIN NO. LKCF 39658A LKSF 39658A |
| | TEIKIN NO. 39658A | TEIKIN NO. R 39162 | TEIKIN NO. P 39232 | TEIKIN NO. B 39162 | TEIKIN NO. LCF 39162 LSF 39162 | | |
| | REFERENCE NO. 8-94436-892-0 8-97089-892-0 8-97109-181-0 8-97176-601-0 | REFERENCE NO. 8-94247-867-0 8-94247-867-1 8-97319-087-0 | REFERENCE NO. 8-94247-968-0 8-94419-455-0 | REFERENCE NO. 8-94110-144-0 8-94462-130-0 8-97176-691-0 | REFERENCE NO. | | |
| | Surface Treatment Bore Clearance Tin Coated MRC: 0.030 mm MP: 16.00 mm | 48 | | | | | |
| 4JA1T NEW DIMAX 2.5L 4 cyl.  | \emptyset 93.00 -17.3 CD 47.8 TL 102.8 | 2 - 2.0 1 - 4.0 | \emptyset 31.00 TL 76.00  | | TL 156.0 OD 95.0 FT 0.9 FD 101.0 | * DIMENSION IS FOR LCF | TEIKIN NO. LKCF 39231 LKSF 39231 LKCF 39231A LKSF 39231A |
| | TEIKIN NO. 39231 39231A | TEIKIN NO. R 39162 | TEIKIN NO. P 39232 | TEIKIN NO. B 39162 | TEIKIN NO. LCF 39162 LSF 39162 | | |
| | REFERENCE NO. 8-97942-985-0 8-97176-691-0 8-97176-695-0 | REFERENCE NO. 8-94247-867-0 8-94247-867-1 8-97319-087-0 | REFERENCE NO. 8-94247-968-0 8-94419-455-0 | REFERENCE NO. 8-94110-144-0 8-94462-130-0 8-97176-691-0 | REFERENCE NO. | | |
| | Surface Treatment Bore Clearance Tin Coated MRC: 0.030 mm MP: 34.20 mm | 49 | | | | | |

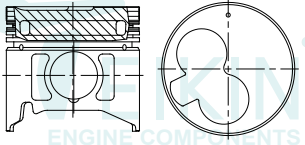







| ENGINE TYPE | PISTON | PISTON RING | PISTON PIN | PIN BUSHING | LINER | | LINER KIT SET |
|---|--|---|---|--|---|-----------|---|
| | | | | | FLANGED | NO FLANGE | |
| 4JB1 2771 cc 4 cyl.  | \emptyset 93.00 -14.4 CD 51.9 TL 91.8 | 2 - 2.0 1 - 4.0 | \emptyset 31.000 TL 77.00  | | TL 181.0 OD 95.0 FT 0.9 FD 101.0 * DIMENSION IS FOR LCF | | TEIKIN NO. LKCF 39163 LKSF 39163 LKCF 39163A LKSF 31963A |
| | TEIKIN NO. 39163 39163A | TEIKIN NO. R 39162 | TEIKIN NO. P 39162 | TEIKIN NO. B 39162 | TEIKIN NO. LCF 39163 LSF 39163 | | |
| | REFERENCE NO. 8-94152-711-1 8-94152-711-0 8-94433-177-1 8-94445-718-0 | REFERENCE NO. 8-94247-867-0 8-94247-867-1 6-97319-087-0 | | REFERENCE NO. 8-94247-968-0 8-94419-455-0 | REFERENCE NO. 8-94247-861-0 8-94247-861-2 | | |
| | Surface Treatment Bore Clearance Tin Coated MRC: 0.030 mm MP: 16.00 mm | | | | | | |
| | | | | | | | 50 |
| 4JB1 LATE 2771 cc 4 cyl.  | \emptyset 93.00 -19.6 CD 51.8 TL 91.8 | 2 - 2.0 1 - 4.0 | \emptyset 31.000 TL 77.00  | | TL 181.0 OD 95.0 FT 0.9 FD 101.0 * DIMENSION IS FOR LCF | | TEIKIN NO. LKCF 39656A LKSF 39656A |
| | TEIKIN NO. 39656A | TEIKIN NO. R 39162 | TEIKIN NO. P 39162 | TEIKIN NO. B 39162 | TEIKIN NO. LCF 39163 LSF 39163 | | |
| | REFERENCE NO. 8-97176-606-0 | REFERENCE NO. 8-94247-867-0 8-94247-867-1 8-97319-087-0 | | REFERENCE NO. 8-94247-968-0 8-94419-455-0 | REFERENCE NO. 8-94247-861-0 8-94247-861-2 | | |
| | Surface Treatment Bore Clearance Tin Coated MRC: 0.040 mm MP: 19.00 mm | | | | | | |
| | | | | | | | 51 |
| 4JB1-T 2771 cc 4 cyl.  | \emptyset 93.00 -13.6 CD 51.9 TL 91.8 | 2 - 2.0 1 - 4.0 | \emptyset 34.000 TL 78.00  | | TL 181.0 OD 95.0 FT 0.9 FD 101.0 * DIMENSION IS FOR LCF | | TEIKIN NO. LKCF 39188 LKSF 39188 LKCF 39188A LKSF 39188A |
| | TEIKIN NO. 39188 39188A | TEIKIN NO. R 39162 | TEIKIN NO. P 39188 | TEIKIN NO. B 39188 | TEIKIN NO. LCF 39163 LSF 39163 | | |
| | REFERENCE NO. 8-97176-602-0 8-94340-620-2 8-94369-218-0 | REFERENCE NO. 8-94247-867-0 8-94247-867-1 8-97319-087-0 | | REFERENCE NO. 8-84457-158-0 | REFERENCE NO. 8-94247-861-0 8-94247-861-2 | | |
| | Surface Treatment Bore Clearance Tin Coated MRC: 0.030 mm MP: 16.00 mm | | | | | | |
| | | | | | | | 52 |
| 4JB1-T LATE 2771 cc 4 cyl.  | \emptyset 93.00 -19.3 CD 51.9 TL 91.8 | 2 - 2.0 1 - 4.0 | \emptyset 34.000 TL 78.00  | | TL 181.0 OD 95.0 FT 0.9 FD 101.0 * DIMENSION IS FOR LCF | | TEIKIN NO. LKCF 39190 LKSF 39190 LKCF 39190A LKSF 39190A |
| | TEIKIN NO. 39190 39190A | TEIKIN NO. R 39162 | TEIKIN NO. P 39188 | TEIKIN NO. B 39188 | TEIKIN NO. LCF 39163 LSF 39163 | | |
| | REFERENCE NO. 8-97108-621-0 8-94460-887-1 | REFERENCE NO. 8-94247-867-0 8-94247-867-1 8-97319-087-0 | | REFERENCE NO. 8-84457-158-0 | REFERENCE NO. 8-94247-861-0 8-94247-861-2 | | |
| | Surface Treatment Bore Clearance Tin Coated MRC: 0.030 mm MP: 16.00 mm | | | | | | |
| | | | | | | | 53 |

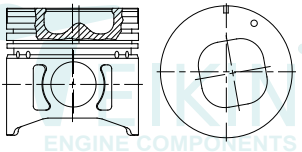

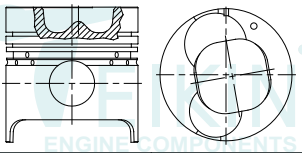

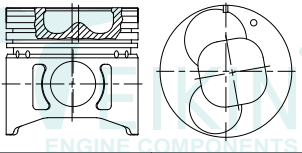

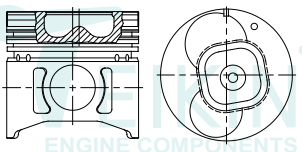

| ENGINE TYPE | PISTON | PISTON RING | PISTON PIN | PIN BUSHING | LINER | | LINER KIT SET |
|--|--|---------------------------------------|---|--|---|---|---------------|
| | | | | | FLANGED | NO FLANGE | |
| 4JG2 EARLY 3059 cc 4 cyl.  | \emptyset 95.40 -2.75 CD 49.2 TL 89.2 | 1 - 2.5 1 - 2.0 1 - 4.0 | \emptyset 34.000 TL 78.00  | | TL 178.6 OD 97.0 FT 1.1 FD 102.3 * DIMENSION IS FOR LCF | TEIKIN NO. LKCF 39600 LKSF 39600 LKCF 39600A LKSF 39600A | |
| | TEIKIN NO. 39600 39600A (39195) | TEIKIN NO. R 39600 | TEIKIN NO. P 39188 | TEIKIN NO. B 39188 | TEIKIN NO. LCF 39232 LSF 39232 | | |
| | REFERENCE NO. 8-97073-647-1 | REFERENCE NO. 8-97080-215-0 | REFERENCE NO. 8-84457-158-0 | REFERENCE NO. 8-97176-702-0 8-94456-791-0 | | | |
| | Surface Treatment Bore Clearance Tin Coated MRC: 0.050 mm MP: 17.80 mm | 54 | | | | | |
| 4JG2-T 3059 cc 4 cyl.  | \emptyset 95.40 -2.8 CD 49.1 TL 89.1 | 1 - 2.5 1 - 2.0 1 - 4.0 | \emptyset 34.000 TL 78.00  | | TL 178.6 OD 97.0 FT 1.1 FD 102.3 * DIMENSION IS FOR LCF | TEIKIN NO. LKCF 39608AG LKSF 39608AG | |
| | TEIKIN NO. 39608AG (39196) | TEIKIN NO. R 39600 | TEIKIN NO. P 39188 | TEIKIN NO. B 39188 | TEIKIN NO. LCF 39232 LSF 39232 | | |
| | REFERENCE NO. 8-97086-449-0 8-97176-622-0 8-97176-623-0 | REFERENCE NO. 8-97080-215-0 | REFERENCE NO. 8-84457-158-0 | REFERENCE NO. 8-97176-702-0 8-94456-791-0 | | | |
| | Surface Treatment Bore Clearance Tin Coated MRC: 0.030 mm Anodized Crown MP: 19.00 mm | 55 | | | | | |
| 4JG2-T NEW 3059 cc 4 cyl.  | \emptyset 95.40 -1.4 CD 49.2 TL 89.2 | 1 - 2.5 1 - 2.0 1 - 4.0 | \emptyset 34.000 TL 78.00  | | TL 178.6 OD 97.0 FT 1.1 FD 102.3 * DIMENSION IS FOR LCF | TEIKIN NO. LKCF 39660AG LKSF 39660AG | |
| | TEIKIN NO. 39660AG | TEIKIN NO. R 39600 | TEIKIN NO. P 39660 | TEIKIN NO. B 39188 | TEIKIN NO. LCF 39232 LSF 39232 | | |
| | REFERENCE NO. 8-97176-624-0 8-97176-624-1 8-97176-625-0 8-97176-625-1 | REFERENCE NO. 8-97080-215-0 | REFERENCE NO. 8-84457-158-0 | REFERENCE NO. 8-97176-702-0 8-94456-791-0 | | | |
| | Surface Treatment Bore Clearance Tin Coated MRC: 0.030 mm Anodized Crown MP: 15.00 mm | 56 | | | | | |
| 4JG2-T-II 3059 cc 4 cyl.  | \emptyset 95.40 -2.7 CD 49.2 TL 89.2 | 1 - 2.5 FK 1 - 2.0 1 - 4.0 | \emptyset 34.000 TL 78.00  | | TL 178.6 OD 97.0 FT 1.1 FD 102.3 * DIMENSION IS FOR LCF | TEIKIN NO. LKCF 39669AG LKSF 39669AG | |
| | TEIKIN NO. 39669AG | TEIKIN NO. R 39669 | TEIKIN NO. P 39188 | TEIKIN NO. B 39188 | TEIKIN NO. LCF 39232 LSF 39232 | | |
| | REFERENCE NO. 8-97176-620-0 8-97176-621-0 | REFERENCE NO. 8-94370-449-0 | REFERENCE NO. 8-84457-158-0 | REFERENCE NO. 8-97176-702-0 8-94456-791-0 | | | |
| | Surface Treatment Bore Clearance Tin Coated MRC: 0.030 mm Anodized Crown MP: 18.00 mm | 57 | | | | | |

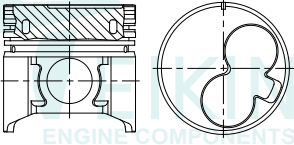
| ENGINE TYPE | PISTON | PISTON RING | PISTON PIN | PIN BUSHING | LINER | | LINER KIT SET |
|--|--|---|--------------------------------------|--------------------------------|---|---------------|---|
| | | | | | FLANGED | NO FLANGE | |
| 4JH1-TC 3000 cc DIMAX 3.0L 4 cyl. | \varnothing 95.40 -20.1 CD 49.9 TL 88.9 | 1 - 2.5 1 - 2.0 1 - 3.0 | \varnothing 31.000 TL 76.00 | | TL 178.6 OD 97.0 FT 1.1 FD 102.3 * DIMENSION IS FOR LCF | | TEIKIN NO. LKCF 39232AG LKSF 39232AG |
| | TEIKIN NO. | TEIKIN NO. | TEIKIN NO. | TEIKIN NO. | TEIKIN NO. | | |
| | 39232AG | R 39232 | P 39232 | B 39232 | LCF 39232 LSF 39232 | | |
| | REFERENCE NO. | REFERENCE NO. | REFERENCE NO. | REFERENCE NO. | REFERENCE NO. | | |
| Surface Treatment Bore Clearance Tin Coated MRC: 0.030 mm MP: 16.00 mm | 8-97305-585-3 8-97305-586-1 | 8-97941-122-0 8-97259-941-0 | | | 8-97176-702-0 8-94456-791-0 | | 58 |
| 4JJ1-TC CRDI 2999 cc 4 cyl. | \varnothing 95.40 -16.1 CD 49.8 TL 78.4 | 1 - 2.0 HK 1 - 1.5 1 - 3.0 | \varnothing 34.000 TL 78.00 | | TL 180.0 OD 99.4 FT 4.0 FD 103.4 | 177.0 99.4 | TEIKIN NO. LKSF 39674AG LKSF 39674AG |
| | TEIKIN NO. | TEIKIN NO. | TEIKIN NO. | TEIKIN NO. | TEIKIN NO. | | |
| | 39674AG | R 39674 | P 39188 | B 39674 | LSF 39674 LSX 39674 | | |
| | REFERENCE NO. | REFERENCE NO. | REFERENCE NO. | REFERENCE NO. | REFERENCE NO. | | |
| Surface Treatment Bore Clearance Moly Skirt MRC: 0.040 mm MP: 7.00 mm | 8-97367-397-1 8-97367-398-1 8-97367-399-1 8-97388-327-0 | 8-97388-734-0 8-97389-284-0 8-98096-676-0 | | 8-97311-438-0 | | | 59 |
| 4JK1-TC 2999 cc 4 cyl. | \varnothing 95.40 -16.7 CD 58.5 TL 87.2 | 1 - 2.0 HK 1 - 1.5 1 - 3.0 | \varnothing 34.000 TL 78.00 | | TL 180.0 OD 99.4 FT 4.0 FD 103.4 | 177.0 99.4 | TEIKIN NO. LKSF 39675AG LKSF 39675AG |
| | TEIKIN NO. | TEIKIN NO. | TEIKIN NO. | TEIKIN NO. | TEIKIN NO. | | |
| | 39675AG | R 39674 | P 39188 | | LSX 39661 LSF 39661 | | |
| | REFERENCE NO. | REFERENCE NO. | REFERENCE NO. | REFERENCE NO. | REFERENCE NO. | | |
| Surface Treatment Bore Clearance Moly Skirt MRC: 0.060 mm MP: 10.00 mm | 8-97355-672-2 | | | | | | 60 |
| 4JX1 2999 cc 4 cyl. | \varnothing 95.40 -17.4 CD 50.0 TL 101.7 | 1 - 2.5 FK 1 - 2.0 1 - 4.0 | \varnothing 31.000 TL 76.00 | | TL 180.0 OD 99.4 FT 4.0 FD 103.4 | 177.0 99.4 | TEIKIN NO. LKSF 39661AG LKSF 39661AG |
| | TEIKIN NO. | TEIKIN NO. | TEIKIN NO. | TEIKIN NO. | TEIKIN NO. | | |
| | 39661AG | R 39661 | P 39232 | B 39162 | LSF 39661 LSX 39661 | | |
| | REFERENCE NO. | REFERENCE NO. | REFERENCE NO. | REFERENCE NO. | REFERENCE NO. | | |
| Surface Treatment Bore Clearance Anodized Crown Moly Skirt MRC: 0.040 mm MP: 17.00 mm | 8-97182-768-1 8-97263-264-2 | 8-97184-533-0 | | 8-94247-968-0 8-94419-455-0 | | | 61 |

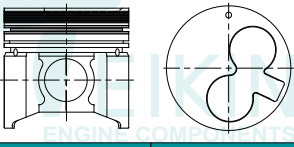

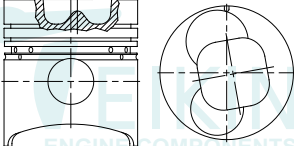

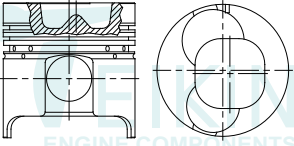



| ENGINE TYPE | PISTON | PISTON RING | PISTON PIN | PIN BUSHING | LINER | | LINER KIT SET |
|---|--|--|------------------------------------|---------------------------------------|---|-----------|---|
| | | | | | FLANGED | NO FLANGE | |
| 4BA1 2775 cc 1973 4 cyl. | \emptyset 98.00 -2.1 CD 62.6 TL 112.3 | 1 - 3.0 1 - 2.5 1 - 5.0 | \emptyset 33.000 TL 85.00 | | TL 180.5 OD 101.0 FT 1.4 FD 108.0 * DIMENSION IS FOR LCF | | TEIKIN NO. LKCF 39160 LKSF 39160 LKCF 39160A LKSF 39160A |
| Surface Treatment Bore Clearance Tin Coated MRC: 0.100 mm MP: 27.00 mm | TEIKIN NO. 39160 39160A | TEIKIN NO. R 39160 | TEIKIN NO. P 39160 | TEIKIN NO. B 39160 | TEIKIN NO. LCF 39160 LSF 39160 | | |
| | REFERENCE NO. 5-12111-055-1 | REFERENCE NO. 5-12121-001-0 5-12121-019-0 5-12181-025-0 9-12181-601-0 | | REFERENCE NO. 9-12251-059-0 | REFERENCE NO. 5-11261-802-0 9-11261-802-2 | | 62 |
| DA220 4084 cc 4 cyl. | \emptyset 100.00 -5.53 CD 62.0 TL 125.0 | 3 - 2.5 1 - 5.0 | \emptyset 34.000 TL 83.50 | | TL 220.0 OD 113.0 FT 8.0 FD 119.0 | | TEIKIN NO. LKFF 39137 |
| Surface Treatment Bore Clearance Tin Coated MRC: 0.080 mm MP: 32.50 mm | TEIKIN NO. 39137-4 | TEIKIN NO. R 39137-4 | TEIKIN NO. P 39138 | TEIKIN NO. B 39137 | TEIKIN NO. LFF 39137 | | |
| | REFERENCE NO. 1-12111-126-0 9-12111-126-0 9-12111-376-0 9-12111-901-0 | REFERENCE NO. 1-12121-001-0 1-12181-005-0 1-12181-006-0 1-12181-038-0 | | REFERENCE NO. 9-12251-083-0 | REFERENCE NO. 9-11261-276-0 9-11261-287-0 9-11261-287-1 | | 63 |
| DA-120-4R 6126 cc 1966 6 cyl. | \emptyset 100.00 -5.53 CD 62.0 TL 125.0 | 3 - 2.5 1 - 5.0 | \emptyset 34.000 TL 83.50 | | TL 220.0 OD 113.0 FT 8.0 FD 119.0 | | TEIKIN NO. LKFF 39137 |
| Surface Treatment Bore Clearance Tin Coated MRC: 0.080 mm MP: 32.50 mm | TEIKIN NO. 39137 | TEIKIN NO. R 39137 | TEIKIN NO. P 39138 | TEIKIN NO. B 39137 | TEIKIN NO. LFF 39137 | | |
| | REFERENCE NO. 9-12111-901-0 1-12111-126-0 9-12111-126-0 9-12111-376-0 | REFERENCE NO. 1-12121-001-0 1-12181-005-0 1-12181-087-0 1-12181-036-0 | | REFERENCE NO. 9-12251-083-0 | REFERENCE NO. 9-11261-276-0 9-11261-287-0 9-11261-287-1 | | 64 |
| DA-120-5R 6126 cc 1961-66 6 cyl. | \emptyset 100.00 -5.53 CD 62.0 TL 125.0 | 3 - 2.5 2 - 4.0 | \emptyset 34.000 TL 83.50 | | | | TEIKIN NO. |
| Surface Treatment Bore Clearance Tin Coated MRC: 0.080 mm MP: 28.50 mm | TEIKIN NO. 39138 | | TEIKIN NO. P 39138 | | | | |
| | REFERENCE NO. 9-12111-196-0 | | | | | | 65 |

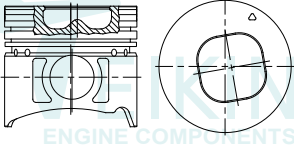

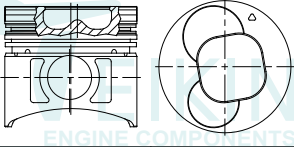

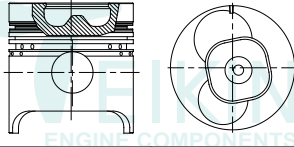

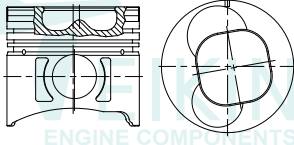

| ENGINE TYPE | PISTON | PISTON RING | PISTON PIN | PIN BUSHING | LINER | | LINER KIT SET |
|--|--|--|---|---|--|-----------|--|
| | | | | | FLANGED | NO FLANGE | |
| 4BB1 3595 cc 1972 4 cyl. | \varnothing 102.00 -19.1 CD 62.8 TL 112.4 | 1 - 3.0 1 - 2.5 1 - 5.0 | \varnothing 35.000 TL 87.50 | | TL 204.0 OD 105.0 FT 1.4 FD 112.0 * DIMENSION IS FOR LCF | | TEIKIN NO. LKCF 39148-4 LKFF 39148-4 LKSF 39148-4 |
| Surface Treatment Tin Coated Bore Clearance MRC: 0.150 mm MP: 66.00 mm | TEIKIN NO. 39148-4 REFERENCE NO. 5-12111-013-0 | TEIKIN NO. R 39165 REFERENCE NO. 5-12121-004-0 5-12121-005-0 5-12181-003-1 5-45454-004-2 | TEIKIN NO. P 39149 REFERENCE NO. 1-12251-027-0 5-12251-006-0 9-12251-602-0 | TEIKIN NO. B 39166 REFERENCE NO. 1-11261-118-0 5-11261-004-0 5-11261-118-0 | | | 66 |
| 4BC1 3268 cc 1979 4 cyl. | \varnothing 102.00 -2.3 CD 58.6 TL 112.1 | 1 - 3.0 1 - 2.5 1 - 5.0 | \varnothing 33.000 TL 83.00 | | TL 187.0 OD 105.0 FT 1.4 FD 112.0 * DIMENSION IS FOR LCF | | TEIKIN NO. LKCF 39165 LKFF 39165 LKSF 39165 LKCF 39165A LKFF 39165A LKSF 39165A |
| Surface Treatment Tin Coated Bore Clearance MRC: 0.100 mm MP: 32.15 mm | TEIKIN NO. 39165 39165A REFERENCE NO. 5-12111-172-1 5-12111-188-1 | TEIKIN NO. R 39165 REFERENCE NO. 5-12121-004-0 5-12121-005-0 5-12181-003-1 5-45454-004-2 | TEIKIN NO. P 39165 REFERENCE NO. 5-12251-010-0 9-12251-603-0 | TEIKIN NO. B 39165 REFERENCE NO. 5-11261-014-0 5-11261-014-2 | | | 67 |
| 4BC2 3268 cc 1981 4 cyl. | \varnothing 102.00 -17.6 CD 58.9 TL 98.2 | 1 - 3.0 1 - 2.5 1 - 5.0 | \varnothing 35.000 TL 85.00 | | TL 187.0 OD 105.0 FT 1.4 FD 112.0 * DIMENSION IS FOR LCF | | TEIKIN NO. LKCF 39166 LKFF 39166 LKSF 39166 LKCF 39166A LKFF 39166A LKSF 39166A |
| Surface Treatment Tin Coated Bore Clearance MRC: 0.050 mm MP: 17.45 mm | TEIKIN NO. 39166 39166A REFERENCE NO. 5-12111-230-4 8-94169-765-0 8-97176-632-0 | TEIKIN NO. R 39165 REFERENCE NO. 5-12121-004-0 5-12121-005-0 5-12181-003-1 5-45454-004-2 | TEIKIN NO. P 39166 REFERENCE NO. 1-12251-027-0 5-12251-006-0 9-12251-602-0 | TEIKIN NO. B 39166 REFERENCE NO. 5-11261-014-0 5-11261-014-2 | | | 68 |
| 4BD1 3856 cc JCR 1976 4 cyl. | \varnothing 102.00 -19.8 CD 58.8 TL 104.3 | 1 - 3.0 1 - 2.5 1 - 5.0 | \varnothing 35.000 TL 87.50 | | TL 204.0 OD 105.0 FT 1.4 FD 112.0 * DIMENSION IS FOR LCF | | TEIKIN NO. LKCF 39149-4 LKFF 39149-4 LKSF 39149-4 LKCF 39149A-4 LKFF 39149A-4 LKSF 39149A-4 |
| Surface Treatment Tin Coated Bore Clearance MRC: 0.170 mm MP: 60.00 mm | TEIKIN NO. 39149-4 39149A-4 REFERENCE NO. 5-12111-068-0 5-12111-068-2 5-12111-211-0 5-12111-211-1 | TEIKIN NO. R 39165 REFERENCE NO. 5-12121-004-0 5-12121-005-0 5-12181-003-1 5-45454-004-2 | TEIKIN NO. P 39149 REFERENCE NO. 1-12251-027-0 5-12251-006-0 9-12251-602-0 | TEIKIN NO. B 39166 REFERENCE NO. 1-11261-118-0 5-11261-004-0 5-11261-118-0 | | | 69 |

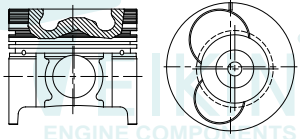

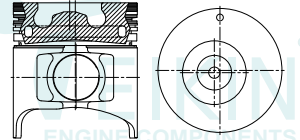

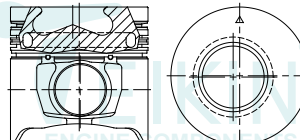

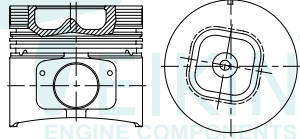

| ENGINE TYPE | PISTON | PISTON RING | PISTON PIN | PIN BUSHING | LINER | | LINER KIT SET |
|---|--|--|---|---|--|--|---------------|
| | | | | | FLANGED | NO FLANGE | |
| 4BD1 LATE 3856 cc 4 cyl.  Surface Treatment Bore Clearance Tin Coated MRC: 0.040 mm MP: 17.50 mm | \emptyset 102.00 -19.9 CD 58.9 TL 98.3 | 1 - 3.0 1 - 2.5 1 - 5.0 | \emptyset 35.000 TL 87.50  | | TL 204.0 OD 105.0 FT 1.4 FD 112.0 * DIMENSION IS FOR LCF | TEIKIN NO. LKCF 39227A LKFF 39227A LKSF 39227A | |
| | TEIKIN NO. | TEIKIN NO. | TEIKIN NO. | TEIKIN NO. | TEIKIN NO. | | |
| | 39227A | R 39165 | P 39149 | B 39166 | LCF 39227 LFF 39227 LSF 39227 | | |
| | REFERENCE NO. | REFERENCE NO. | REFERENCE NO. | REFERENCE NO. | REFERENCE NO. | | |
| | 8-94452-912-0 | 5-12121-004-0 5-12121-005-0 5-12181-003-1 5-45454-004-2 | 1-12251-027-0 5-12251-006-0 9-12251-602-0 | 1-11261-118-0 5-11261-004-0 5-11261-118-0 | | | |
| 4BD1-II 3865 cc 4 cyl. 1985  Surface Treatment Bore Clearance Tin Coated MRC: 0.170 mm MP: 59.25 mm | \emptyset 102.00 -19.7 CD 58.8 TL 104.2 | 1 - 3.0 1 - 2.5 1 - 5.0 | \emptyset 35.000 TL 87.50  | | TL 204.0 OD 105.0 FT 1.4 FD 112.0 * DIMENSION IS FOR LCF | TEIKIN NO. LKCF 39151A-4 LKFF 39151A-4 LKSF 39151A-4 | |
| | TEIKIN NO. | TEIKIN NO. | TEIKIN NO. | TEIKIN NO. | TEIKIN NO. | | |
| | 39151A-4 | R 39165 | P 39149 | B 39166 | LCF 39227 LFF 39227 LSF 39227 | | |
| | REFERENCE NO. | REFERENCE NO. | REFERENCE NO. | REFERENCE NO. | REFERENCE NO. | | |
| | 1-12111-240-1 1-12111-303-0 1-12111-773-0 5-12111-240-1 | 5-12121-004-0 5-12121-005-0 5-12181-003-1 5-45454-004-2 | 1-12251-027-0 5-12251-006-0 9-12251-602-0 | 1-11261-118-0 5-11261-004-0 5-11261-118-0 | | | |
| 4BD1-III 5785 cc 4 cyl.  Surface Treatment Bore Clearance Tin Coated MRC: 0.040 mm MP: 17.50 mm | \emptyset 102.00 -19.9 CD 58.9 TL 98.3 | 1 - 3.0 1 - 2.5 1 - 5.0 | \emptyset 35.000 TL 87.50  | | | TEIKIN NO. | |
| | TEIKIN NO. | TEIKIN NO. | TEIKIN NO. | | | | |
| | 39184 39184A | | P 39149 | | | | |
| | REFERENCE NO. | | | | | | |
| | 5-12111-649-1 | | | | | | |
| 4BD1-T 3856 cc 4 cyl.  Surface Treatment Bore Clearance Tin Coated MRC: 0.030 mm MP: 17.80 mm | \emptyset 102.00 -19.5 CD 58.8 TL 98.0 | 1 - 3.0 1 - 2.5 1 - 5.0 | \emptyset 35.000 TL 87.50  | | TL 204.0 OD 105.0 FT 4.0 FD 112.0 * DIMENSION IS FOR LCF | TEIKIN NO. LKCF 39618 LKFF 39618 LKSF 39618 LKCF 39618A LKFF 39618A LKSF 39618A | |
| | TEIKIN NO. | TEIKIN NO. | TEIKIN NO. | TEIKIN NO. | TEIKIN NO. | | |
| | 39618 39618A (39213) | R 39615 | P 39149 | B 39166 | LCF 39227 LFF 39227 LSF 39227 | | |
| | REFERENCE NO. | REFERENCE NO. | REFERENCE NO. | REFERENCE NO. | REFERENCE NO. | | |
| | 8-94321-734-0 8-94175-027-2 5-12111-242-1 5-87810-280-3 | 5-12121-004-0 5-12121-005-1 5-45454-004-2 5-12181-003-1 | 1-12251-027-0 5-12251-006-0 9-12251-602-0 | 1-11261-118-0 5-11261-004-0 5-11261-118-0 | | | |

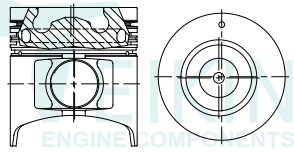

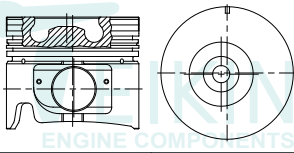

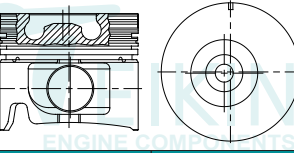

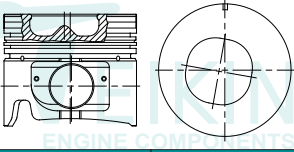

| ENGINE TYPE | PISTON | PISTON RING | PISTON PIN | PIN BUSHING | LINER | | LINER KIT SET |
|--|--|--|---|---|--|-----------|---|
| | | | | | FLANGED | NO FLANGE | |
| 4BD2-T 3856 cc 4 cyl.  | \emptyset 102.00 -2.6 CD 58.7 TL 98.1 | 1 - 3.0 1 - 2.5 1 - 5.0 | \emptyset 35.000 TL 87.40  | | TL 204.0 OD 105.0 FT 1.4 FD 112.0 * DIMENSION IS FOR LCF | | TEIKIN NO. LKCF 39611AG LKFF 39611AG LKSF 39611AG |
| | TEIKIN NO. 39611AG (39200) | TEIKIN NO. R 39165 | TEIKIN NO. P 39611 | TEIKIN NO. B 39166 | TEIKIN NO. LCF 39227 LFF 39227 LSF 39227 | | |
| | REFERENCE NO. 8-97025-457-2 8-97176-640-0 | REFERENCE NO. 5-12121-004-0 5-12121-005-0 5-12181-003-1 5-45454-004-2 | REFERENCE NO. 1-12251-027-0 5-12251-006-0 9-12251-602-0 | REFERENCE NO. 1-11261-118-0 5-11261-004-0 5-11261-118-0 | | | |
| | Surface Treatment Bore Clearance Tin Coated MRC: 0.040 mm Anodized Crown MP: 17.00 mm | | | | | | |
| 4BD2-T LATE 3856 cc 1995-98 4 cyl.  | \emptyset 102.00 -3.25 CD 58.8 TL 98.1 | 1 - 3.0 1 - 2.0 1 - 4.0 | \emptyset 35.000 TL 87.50  | | TL 204.0 OD 105.0 FT 1.4 FD 112.0 * DIMENSION IS FOR LCF | | TEIKIN NO. LKCF 39655AG LKFF 39655AG LKSF 39655AG |
| | TEIKIN NO. 39655AG | TEIKIN NO. R 39655 | TEIKIN NO. P 39149 | TEIKIN NO. B 39166 | TEIKIN NO. LCF 39227 LFF 39227 LSF 39227 | | |
| | REFERENCE NO. 8-97176-642-0 | REFERENCE NO. 8-97117-686-0 | REFERENCE NO. 1-12251-027-0 5-12251-006-0 9-12251-602-0 | REFERENCE NO. 1-11261-118-0 5-11261-004-0 5-11261-118-0 | | | |
| | Surface Treatment Bore Clearance Tin Coated MRC: 0.030 mm Anodized Crown MP: 15.00 mm | | | | | | |
| 6BB1 5393 cc 1972 6 cyl.  | \emptyset 102.00 -19.1 CD 62.8 TL 112.4 | 1 - 3.0 1 - 2.5 1 - 5.0 | \emptyset 35.000 TL 87.50  | | TL 204.0 OD 105.0 FT 1.4 FD 112.0 * DIMENSION IS FOR LCF | | TEIKIN NO. LKCF 39148 LKSF 39148 LKCF 39148A LKSF 39148A |
| | TEIKIN NO. 39148 39148A | TEIKIN NO. R 39148 | TEIKIN NO. P 39149 | TEIKIN NO. B 39148 | TEIKIN NO. LCF 39148 LSF 39148 | | |
| | REFERENCE NO. 5-12111-013-0 | REFERENCE NO. 5-12121-005-0 5-12181-023-2 | REFERENCE NO. 1-12251-027-0 5-12251-006-0 | REFERENCE NO. 5-11261-004-0 5-11261-118-0 | | | |
| | Surface Treatment Bore Clearance Tin Coated MRC: 0.150 mm MP: 66.00 mm | | | | | | |
| 6BD1 5785 cc JCR 1976 6 cyl.  | \emptyset 102.00 -19.8 CD 58.8 TL 104.3 | 1 - 3.0 1 - 2.5 1 - 5.0 | \emptyset 35.000 TL 87.50  | | TL 204.0 OD 105.0 FT 1.4 FD 112.0 * DIMENSION IS FOR LCF | | TEIKIN NO. LKCF 39149 LKSF 39149 LKCF 39149A LKSF 39149A |
| | TEIKIN NO. 39149 39149A | TEIKIN NO. R 39148 | TEIKIN NO. P 39149 | TEIKIN NO. B 39148 | TEIKIN NO. LCF 39148 LSF 39148 | | |
| | REFERENCE NO. 5-12111-068-0 5-12111-068-2 5-12111-211-0 5-12111-211-1 | REFERENCE NO. 5-12121-005-0 5-12181-023-2 | REFERENCE NO. 1-12251-027-0 5-12251-006-0 | REFERENCE NO. 5-11261-004-0 5-11261-118-0 | | | |
| | Surface Treatment Bore Clearance Tin Coated MRC: 0.170 mm MP: 60.00 mm | | | | | | |

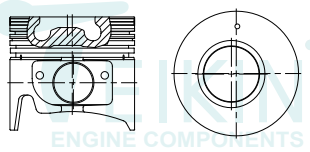

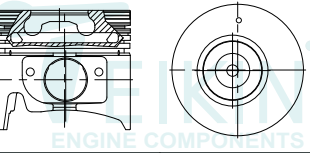

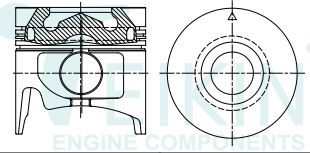

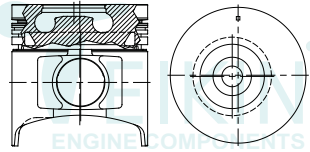

| ENGINE TYPE | PISTON | PISTON RING | PISTON PIN | PIN BUSHING | LINER | | LINER KIT SET |
|--|---|---|--------------------------|---|--|-----------|--|
| | | | | | FLANGED | NO FLANGE | |
| 6BD1-II 1985 5785 cc 6 cyl. | Ø 102.00 -19.7 CD 58.8 TL 104.2 | 1 - 3.0 1 - 2.5 1 - 5.0 | Ø 35.000 TL 87.50 | | TL 204.0 OD 105.0 FT 1.4 FD 112.0 * DIMENSION IS FOR LCF | | TEIKIN NO. LKCF 39151 LKSF 39151 LKCF 39151A LKSF 39151A |
| Surface Treatment: Tin Coated Bore Clearance: MRC: 0.170 mm MP: 59.25 mm | TEIKIN NO. 39151 39151A | TEIKIN NO. R 39148 | TEIKIN NO. P 39149 | TEIKIN NO. B 39148 | TEIKIN NO. LCF 39148 LSF 39148 | | |
| | REFERENCE NO. 1-12111-240-1 1-12111-303-0 1-12111-773-0 5-12111-240-1 | REFERENCE NO. 5-12121-005-0 5-12181-023-2 | | REFERENCE NO. 1-12251-027-0 5-12251-006-0 | REFERENCE NO. 5-11261-004-0 5-11261-118-0 | | 78 |
| 6BD1-III 5785 cc 6 cyl. | Ø 102.00 -19.9 CD 58.9 TL 98.3 | 1 - 3.0 1 - 2.5 1 - 5.0 | Ø 35.000 TL 87.50 | | TL 204.0 OD 105.0 FT 1.4 FD 112.0 * DIMENSION IS FOR LCF | | TEIKIN NO. LKCF 39184-6 LKSF 39184-6 LKCF 39184A-6 LKSF 39184A-6 |
| Surface Treatment: Tin Coated Bore Clearance: MRC: 0.040 mm MP: 17.50 mm | TEIKIN NO. 39184-6 39184A-6 | TEIKIN NO. R 39184-6 | TEIKIN NO. P 39149 | TEIKIN NO. B 39148 | TEIKIN NO. LCF 39148 LSF 39148 | | |
| | REFERENCE NO. 5-12111-649-1 | REFERENCE NO. | | REFERENCE NO. 1-12251-027-0 5-12251-006-0 | REFERENCE NO. 5-11261-004-0 5-11261-118-0 | | 79 |
| 6BD1-T 5785 cc 6 cyl. | Ø 102.00 -19.8 CD 58.8 TL 98.0 | 1 - 3.0 1 - 2.5 1 - 5.0 | Ø 35.000 TL 87.00 | | TL 204.0 OD 105.0 FT 1.4 FD 112.0 * DIMENSION IS FOR LCF | | TEIKIN NO. LKCF 39667A LKSF 39667A |
| Surface Treatment: Tin Coated Bore Clearance: MRC: 0.040 mm MP: 17.50 mm | TEIKIN NO. 39667A | TEIKIN NO. R 39148 | TEIKIN NO. P 39667 | TEIKIN NO. B 39148 | TEIKIN NO. LCF 39148 LSF 39148 | | |
| | REFERENCE NO. 1-12111-325-1 1-12111-428-0 1-12111-428-1 | REFERENCE NO. 5-12121-005-0 5-12181-023-2 | | REFERENCE NO. 1-12251-027-0 5-12251-006-0 | REFERENCE NO. 5-11261-004-0 5-11261-118-0 | | 80 |
| DA-640 1966 6373 cc 6 cyl. | Ø 102.00 -6.1 CD 68.0 TL 125.0 | 3 - 2.5 1 - 5.0 | Ø 36.000 TL 86.50 | | TL 228.0 OD 113.0 FT 8.0 FD 119.0 | | TEIKIN NO. LKFF 39142 LKFF 39142A |
| Surface Treatment: Tin Coated Bore Clearance: MRC: 0.080 mm MP: 19.50 mm | TEIKIN NO. 39142 39142A | TEIKIN NO. R 39142 | TEIKIN NO. P 39142 | TEIKIN NO. B 39142 | TEIKIN NO. LFF 39142 | | |
| | REFERENCE NO. 1-12111-740-0 1-12111-122-0 9-12111-740-0 9-12111-902-1 | REFERENCE NO. 1-12121-009-0 1-12181-007-0 1-12181-110-0 1-12181-074-0 | | REFERENCE NO. 9-12251-084-0 | REFERENCE NO. 9-11261-277-0 5-11261-288-0 | | 81 |

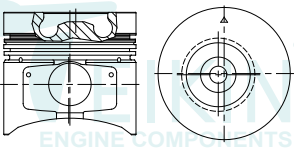
| ENGINE TYPE | PISTON | PISTON RING | PISTON PIN | PIN BUSHING | LINER | | LINER KIT SET | |
|--|--|--|---|---|--|-----------|---|-----------|
| | | | | | FLANGED | NO FLANGE | | |
| 4BE1 3636 cc 4 cyl.  Surface Treatment Tin Coated Bore Clearance MRC: 0.030 mm MP: 17.65 mm | \emptyset 105.00 -18.1 CD 56.4 TL 95.7 | 1 - 3.0 1 - 2.5 1 - 5.0 | \emptyset 35.000 TL 85.00  | | TL 187.0 OD 107.0 FT 1.4 FD 113.0 | | TEIKIN NO. LKCF 39180 LKCF 39180A | |
| | TEIKIN NO. 39180 39180A | TEIKIN NO. R 39180 | TEIKIN NO. P 39166 | TEIKIN NO. B 39166 | TEIKIN NO. LCF 39180 | | | |
| | REFERENCE NO. 8-94478-116-0 | REFERENCE NO. 8-94418-918-0 | | REFERENCE NO. 1-12251-027-0 5-12251-006-0 9-12251-602-0 | REFERENCE NO. 5-11261-016-2 | | | |
| | | | | | | | | 82 |
| 4BE1-II 3636 cc 4 cyl.  Surface Treatment Tin Coated Bore Clearance MRC: 0.120 mm MP: 21.00 mm | \emptyset 105.00 -18.1 CD 56.4 TL 95.6 | 1 - 3.0 1 - 2.5 1 - 5.0 | \emptyset 35.000 TL 85.00  | | TL 187.0 OD 107.0 FT 1.4 FD 113.0 | | TEIKIN NO. LKCF 39612 LKCF 39612A | |
| | TEIKIN NO. 39612 39612A (39201) | TEIKIN NO. R 39180 | TEIKIN NO. P 39166 | TEIKIN NO. B 39166 | TEIKIN NO. LCF 39180 | | | |
| | REFERENCE NO. 8-94438-989-1 8-97176-644-1 5-12111-022-0 | REFERENCE NO. 8-94418-918-0 | | REFERENCE NO. 1-12251-027-0 5-12251-006-0 9-12251-602-0 | REFERENCE NO. 5-11261-016-2 | | | |
| | | | | | | | | 83 |
| 6BF-1 6130 cc 6 cyl.  Surface Treatment Tin Coated Bore Clearance MRC: 0.090 mm MP: 41.00 mm | \emptyset 105.00 -19.8 CD 58.7 TL 110.0 | 1 - 3.0 1 - 2.5 1 - 5.0 | \emptyset 35.000 TL 87.50  | | TL 203.0 OD 107.0 FT 1.4 FD 112.8 * DIMENSION IS FOR LCF | | TEIKIN NO. LKCF 39616 LKFF 39616 LKCF 39616A LKFF 39616A | |
| | TEIKIN NO. 39616 39616A (39206) | TEIKIN NO. R 39616 | TEIKIN NO. P 39149 | TEIKIN NO. B 39148 | TEIKIN NO. LCF 39182 LFF 39182 | | | |
| | REFERENCE NO. 1-12111-345-0 | REFERENCE NO. 1-12121-052-0 5-12121-006-0 | | REFERENCE NO. 1-12251-027-0 5-12251-006-0 | REFERENCE NO. 1-11261-119-0 | | | |
| | | | | | | | | 84 |
| 6BG1 6494 cc 6 cyl.  Surface Treatment Tin Coated Bore Clearance MRC: 0.030 mm MP: 17.90 mm | \emptyset 105.00 -18.8 CD 55.3 TL 94.5 | 1 - 3.0 1 - 2.5 1 - 4.0 | \emptyset 35.000 TL 87.50  | | TL 203.0 OD 107.0 FT 1.4 FD 112.8 * DIMENSION IS FOR LCF | | TEIKIN NO. LKCF 39182 LKFF 39182 LKCF 39182A LKFF 39182A | |
| | TEIKIN NO. 39182 39182A | TEIKIN NO. R 39182 | TEIKIN NO. P 39149 | TEIKIN NO. B 39148 | TEIKIN NO. LCF 39182 LFF 39182 | | | |
| | REFERENCE NO. 1-12111-377-4 1-12111-323-2 1-12111-528-0 1-12111-529-0 | REFERENCE NO. 1-12121-065-0 | | REFERENCE NO. 1-12251-027-0 5-12251-006-0 | REFERENCE NO. 1-11261-119-0 | | | |
| | | | | | | | | 85 |

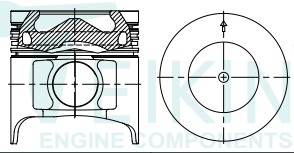

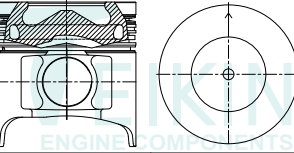

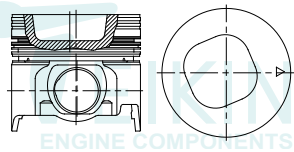

| ENGINE TYPE | PISTON | PISTON RING | PISTON PIN | PIN BUSHING | LINER | | LINER KIT SET |
|---|--|---|---|--|--|-----------|---|
| | | | | | FLANGED | NO FLANGE | |
| 6BG1-T 6494 cc 6 cyl.  Surface Treatment Tin Coated Bore Clearance MRC: 0.020 mm MP: 12.50 mm | \emptyset 105.00 -22.0 CD 55.2 TL 94.5 | 1 - 3.5 1 - 2.5 1 - 4.0 | \emptyset 35.000 TL 87.50  | | TL 203.0 OD 107.0 FT 1.4 FD 112.8 * DIMENSION IS FOR LCF | | TEIKIN NO. LKCF 39614 LKFF 39614 LKCF 39614AG LKFF 39614AG |
| | TEIKIN NO. 39614 39614AG (39203) | TEIKIN NO. R 39614 | TEIKIN NO. P 39149 | TEIKIN NO. B 39148 | TEIKIN NO. LCF 39182 LFF 39182 | | |
| | REFERENCE NO. 1-12111-626-0 | REFERENCE NO. 1-12121-115-0 | REFERENCE NO. 1-12251-027-0 5-12251-006-0 | REFERENCE NO. 1-11261-119-0 | | | |
| | | | | | | | 86 |
| 4HE1-T 4751 cc 4 cyl.  Surface Treatment Tin Coated Bore Clearance MRC: 0.060 mm MP: 30.00 mm | \emptyset 110.00 -22.3 CD 66.2 TL 120.0 | 1 - 3.0 HK 1 - 2.5 1 - 4.0 | \emptyset 40.000 TL 87.00  | | TL 210.0 OD 115.0 FT 5.7 +0.4 FD 121.7 | | TEIKIN NO. LKFF 39666AG LKSF 39666AG |
| | TEIKIN NO. 39666AG | TEIKIN NO. R 39666 | TEIKIN NO. P 39666 | TEIKIN NO. B 39664 | TEIKIN NO. LFF 39666 LSF 39666 | | |
| | REFERENCE NO. 8-97176-652-0 8-97183-664-0 8-97183-665-0 8-97233-129-0 | REFERENCE NO. 8-97078-779-0 | REFERENCE NO. 8-94394-613-0 | REFERENCE NO. 8-97176-723-0 8-97176-724-0 8-97176-725-0 8-97176-726-0 | | | |
| | | | | | | | 87 |
| 4HE1-TC 4751 cc 4 cyl.  Surface Treatment Moly Skirt Bore Clearance MRC: 0.050 mm MP: 16.00 mm | \emptyset 110.00 -22.60 CD 66.2 TL 110.0 | 1 - 3.0 HK 1 - 2.0 1 - 1.2 1 - 3.0 | \emptyset 40.000 TL 87.00  | | TL 210.0 OD 113.0 FT 5.6 +0.4 FD 119.7 | | TEIKIN NO. LKFF 39664AG LKSF 39664AG |
| | TEIKIN NO. 39664AG | TEIKIN NO. R 39664 | TEIKIN NO. P 39664 | TEIKIN NO. B 39664 | TEIKIN NO. LFF 39664 LSF 39664 | | |
| | REFERENCE NO. 8-94391-696-0 | REFERENCE NO. 8-97166-992-0 | REFERENCE NO. 8-94394-613-0 | REFERENCE NO. 8-94391-600-0 8-94391-601-0 | | | |
| | | | | | | | 88 |
| 6HE1 7127 cc 6 cyl.  Surface Treatment Tin Coated Bore Clearance MRC: 0.050 mm MP: 18.00 mm | \emptyset 110.00 -19.5 CD 66.0 TL 99.9 | 1 - 3.0 1 - 2.5 1 - 4.0 | \emptyset 36.000 TL 79.00  | | TL 210.0 OD 113.0 FT 6.0 FD 120.0 | | TEIKIN NO. LKFF 39607 LKSF 39607 LKFF 39607A LKSF 39607A |
| | TEIKIN NO. 39607 39607A (39194) | TEIKIN NO. R 39607 | TEIKIN NO. P 39607 | TEIKIN NO. B 39607 | TEIKIN NO. LFF 39607 LSF 39607 | | |
| | REFERENCE NO. 8-94396-837-0 | REFERENCE NO. 8-94396-840-0 | REFERENCE NO. | REFERENCE NO. | REFERENCE NO. 8-94396-332-0 | | |
| | | | | | | | 89 |

| ENGINE TYPE | PISTON | PISTON RING | PISTON PIN | PIN BUSHING | LINER | | LINER KIT SET | | | |
|--|---|---|---|------------------------------|---|--|--|---------------------------------------|---|-----------|
| | | | | | FLANGED | NO FLANGE | | | | |
| 6HE1-T 7127 cc 6 cyl.  | \emptyset 110.00 -22.0 CD 66.1 TL 119.9 | 1 - 3.9 FK 1 - 3.0 1 - 2.5 1 - 3.0 | \emptyset 40.000 TL 87.00  | | TL 210.0 OD 113.0 FT 5.6 +0.4 FD 119.7 | | TEIKIN NO. LKFF 39663AG LKSF 39663AG | | | |
| Surface Treatment Bore Clearance Tin Coated MRC: 0.110 mm MP: 28.00 mm | TEIKIN NO. 39663AG | TEIKIN NO. R 39663 | TEIKIN NO. P 39663 | TEIKIN NO. B 39663 | TEIKIN NO. LFF 39663 LSF 39663 | REFERENCE NO. 8-94391-594-0 | REFERENCE NO. 8-94390-529-1 8-94395-061-3 8-94395-061-4 8-94395-061-5 | REFERENCE NO. 8-94394-613-0 | REFERENCE NO. 8-94391-600-0 8-94391-601-0 | 90 |
| 4HF1 4334 cc 4 cyl.  | \emptyset 112.00 -21.4 CD 60.8 TL 94.6 | 1 - 3.0 1 - 2.5 1 - 4.0 | \emptyset 36.000 TL 79.00  | | TL 180.0 OD 115.0 FT 6.0 FD 122.0 | | TEIKIN NO. LKFF 39181 LKSF 39181 LKFF 39181A LKSF 39181A | | | |
| Surface Treatment Bore Clearance Tin Coated MRC: 0.050 mm MP: 9.50 mm | TEIKIN NO. 39181 39181A | TEIKIN NO. R 39181 | TEIKIN NO. P 39181 | TEIKIN NO. B 39181 | TEIKIN NO. LFF 39181 LSF 39181 | REFERENCE NO. 8-97095-585-1 | REFERENCE NO. 8-97028-691-0 | REFERENCE NO. 1-12251-036-0 | REFERENCE NO. 8-97144-174-0 8-97176-727-0 | 91 |
| 4HF1 NEW 4334 cc 4 cyl.  | \emptyset 112.00 -22.1 CD 60.8 TL 94.5 | 1 - 3.0 HK 1 - 2.5 1 - 4.0 | \emptyset 36.000 TL 79.00  | | TL 180.0 OD 115.0 FT 6.0 FD 122.0 | | TEIKIN NO. LKSF 39672A LKFF 39672A | | | |
| Surface Treatment Bore Clearance Tin Coated MRC: 0.050 mm MP: 9.50 mm | TEIKIN NO. 39672A | TEIKIN NO. R 39672 | TEIKIN NO. P 39181 | TEIKIN NO. B 39181 | TEIKIN NO. LSF 39181 LFF 39181 | REFERENCE NO. 8-97183-667-0 | REFERENCE NO. 8-97109-462-0 | REFERENCE NO. 1-12251-036-0 | REFERENCE NO. 8-97144-174-0 8-97176-727-0 8-97176-728-0 | 92 |
| 4HF1-II 4334 cc 4 cyl.  | \emptyset 112.00 -18.5 CD 60.8 TL 94.6 | 1 - 3.0 1 - 2.5 1 - 4.0 | \emptyset 36.000 TL 79.00  | | TL 180.0 OD 115.0 FT 6.0 FD 122.0 | | TEIKIN NO. LKFF 39187 LKSF 39187 LKFF 39187A LKSF 39187A | | | |
| Surface Treatment Bore Clearance Tin Coated MRC: 0.050 mm MP: 9.50 mm | TEIKIN NO. 39187 39187A | TEIKIN NO. R 39181 | TEIKIN NO. P 39181 | TEIKIN NO. B 39181 | TEIKIN NO. LFF 39181 LSF 39181 | REFERENCE NO. 8-97095-654-0 8-97063-867-0 | REFERENCE NO. 8-97028-691-0 | REFERENCE NO. 1-12251-036-0 | REFERENCE NO. 8-97144-174-0 8-97176-727-0 | 93 |

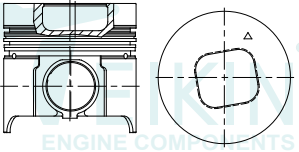
| ENGINE TYPE | PISTON | PISTON RING | PISTON PIN | PIN BUSHING | LINER | | LINER KIT SET |
|--|---|---|---|--|---|-----------|---|
| | | | | | FLANGED | NO FLANGE | |
| 4HG1 4751 cc 4 cyl.  Surface Treatment: Tin Coated Bore Clearance: MRC: 0.030 mm, MP: 19.50 mm | \emptyset 115.00 -22.0 CD 60.7 TL 104.4 | 1 - 3.0 HK 1 - 2.5 1 - 4.0 | \emptyset 36.000 TL 79.00  | | TL 180.0 OD 118.0 FT 6.1 FD 123.6 | | TEIKIN NO. LKFF 39653 LKSF 39653 LKFF 39653A LKSF 39653A |
| | TEIKIN NO. 39653 39653A | TEIKIN NO. R 39653 | TEIKIN NO. P 39181 | TEIKIN NO. B 39181 | TEIKIN NO. LFF 39653 LSF 39653 | | |
| | REFERENCE NO. 8-97183-666-0 | REFERENCE NO. 8-97105-867-0 8-97219-054-0 8-98055-478-0 | REFERENCE NO. 1-12251-036-0 | REFERENCE NO. 8-97351-558-1 | | | |
| | 94 | | | | | | |
| 4HG1-T 4751 cc 4 cyl.  Surface Treatment: Tin Coated Bore Clearance: MRC: 0.050 mm, MP: 35.00 mm | \emptyset 115.00 -22.5 CD 60.7 TL 119.4 | 1 - 3.0 HK 1 - 2.5 1 - 4.0 | \emptyset 36.000 TL 79.00  | | TL 180.0 OD 115.0 FT 6.0 FD 123.6 | | TEIKIN NO. LKSF 39676AG LKFF 39676AG |
| | TEIKIN NO. 39676AG | TEIKIN NO. R 39653 | TEIKIN NO. P 39670 | TEIKIN NO. B 39181 | TEIKIN NO. LSF 39653 LFF 39653 | | |
| | REFERENCE NO. 8-97219-032-0 | REFERENCE NO. 8-97105-867-0 8-97219-054-0 8-98055-478-0 | REFERENCE NO. 1-12251-036-0 | REFERENCE NO. 8-97176-729-0 8-97176-730-0 8-97351-558-0/1 8-97351-559-0/1 | | | |
| | 95 | | | | | | |
| 4HL1 4777 cc 4 cyl.  Surface Treatment: Moly Skirt Bore Clearance: MRC: 0.030 mm, MP: 29.50 mm | \emptyset 115.00 -21.0 CD 58.2 TL 112.0 | 1 - 3.0 1 - 2.0 1 - 3.0 | \emptyset 36.000 TL 79.00  | | TL 190.0 OD 118.0 FT 6.0 FD 123.7 | | TEIKIN NO. LKFF 39670AG LKSF 39670AG |
| | TEIKIN NO. 39670AG | TEIKIN NO. R 39670 | TEIKIN NO. P 39670 | TEIKIN NO. B 39181 | TEIKIN NO. LFF 39670 LSF 39670 | | |
| | REFERENCE NO. 8-97331-643-0 | REFERENCE NO. 8-97331-641-0 | REFERENCE NO. 1-12251-036-0 | REFERENCE NO. | | | |
| | 96 | | | | | | |
| 4HK1-TC-II 5193 cc 4 cyl.  Surface Treatment: Moly Skirt Bore Clearance: MRC: 0.050 mm, MP: 28.00 mm | \emptyset 115.00 -24.0 CD 66.0 TL 119.8 | 1 - 3.0 HK 1 - 2.5 1 - 4.0 | \emptyset 40.000 TL 87.00  | | TL 210.0 OD 118.0 FT 6.0 FD 123.7 | | TEIKIN NO. LKFF 39671AG LKSF 39671AG |
| | TEIKIN NO. 39671AG | TEIKIN NO. R 39653 | TEIKIN NO. P 39663 | TEIKIN NO. B 39671 | TEIKIN NO. LFF 39671 LSF 39671 | | |
| | REFERENCE NO. 8-97228-303-0 | REFERENCE NO. 8-97105-867-0 8-97219-054-0 8-98055-478-0 | REFERENCE NO. 8-94391-794-0 | REFERENCE NO. 8-98014-046-0 8-98014-047-0 | | | |
| | 97 | | | | | | |

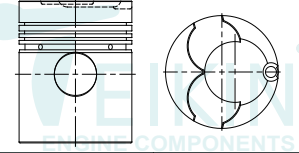
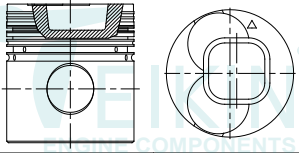
| ENGINE TYPE | PISTON | PISTON RING | PISTON PIN | PIN BUSHING | LINER | | LINER KIT SET |
|---|---|--|---|--|---|-----------|---|
| | | | | | FLANGED | NO FLANGE | |
| 6HH1 8226 cc 6 cyl.  Surface Treatment Tin Coated Bore Clearance MRC: 0.020 mm MP: 20.00 mm | \emptyset 115.00 -22.6 CD 62.7 TL 106.5 | 1 - 3.5 1 - 2.5 1 - 4.0 | \emptyset 36.000 TL 79.00  | | TL 210.0 OD 118.0 FT 6.0 FD 123.7 | | TEIKIN NO. LKFF 39651A LKSF 39651A |
| | TEIKIN NO. 39651A | TEIKIN NO. R 39651 | TEIKIN NO. P 39181 | TEIKIN NO. B 39607 | TEIKIN NO. LFF 39651 LSF 39651 | | |
| | REFERENCE NO. 8-94391-950-0 | REFERENCE NO. 8-94390-799-0 8-94390-799-2 | REFERENCE NO. | REFERENCE NO. | REFERENCE NO. 8-94391-602-0 8-94391-603-0 8-94393-273-1 | | |
| | 98 | | | | | | |
| 6HK1-TC 7790 cc 6 cyl.  Surface Treatment Tin Coated Bore Clearance MRC: 0.020 mm MP: 28.00 mm | \emptyset 115.00 -20.0 CD 66.1 TL 119.7 | 1 - 2.95 HK 1 - 2.0 1 - 2.5 1 - 3.0 | \emptyset 40.000 TL 87.00  | | TL 210.0 OD 118.0 FT 6.0 FD 123.7 | | TEIKIN NO. LKFF 39665AG LKSF 39665AG |
| | TEIKIN NO. 39665AG | TEIKIN NO. R 39665 | TEIKIN NO. P 39665 | TEIKIN NO. B 39663 | TEIKIN NO. LFF 39651 LSF 39651 | | |
| | REFERENCE NO. 8-94391-895-1 | REFERENCE NO. 8-94391-502-3 8-94391-502-4 | REFERENCE NO. | REFERENCE NO. 8-94394-613-0 | REFERENCE NO. 8-94391-602-0 8-94391-603-0 8-94393-273-1 | | |
| | 99 | | | | | | |
| 6HL1-TC 7166 cc 6 cyl.  Surface Treatment Tin Coated Bore Clearance MRC: 0.020 mm MP: 28.00 mm | \emptyset 115.00 -19.0 CD 66.1 TL 119.9 | 1 - 3.0 FK 1 - 2.5 1 - 3.0 | \emptyset 40.000 TL 87.00  | | TL 210.0 OD 118.0 FT 6.0 FD 123.7 | | TEIKIN NO. LKSF 39677AG LKFF 39677AG |
| | TEIKIN NO. 39677AG | TEIKIN NO. R 39677 | TEIKIN NO. P 39655 | TEIKIN NO. B 39663 | TEIKIN NO. LSF 39651 LFF 39651 | | |
| | REFERENCE NO. 8-97602-904-0 | REFERENCE NO. 8-97601-318-1 | REFERENCE NO. | REFERENCE NO. 8-94394-613-0 | REFERENCE NO. 8-94391-603-1 8-94393-273-1 | | |
| | 100 | | | | | | |
| 6SA1 8413 cc 6 cyl.  Surface Treatment Tin Coated Bore Clearance MRC: 0.014 mm MP: 10.00 mm | \emptyset 115.00 -22.7 CD 67.8 TL 104.0 | 1 - 3.0 1 - 2.5 1 - 4.0 | \emptyset 38.000 TL 80.00  | | TL 216.0 OD 119.0 FT 6.0 FD 120.0 | | TEIKIN NO. LKFF 39606 LKSF 39606 LKFF 39606A LKSF 39606A |
| | TEIKIN NO. 39606 39606A (39192) | TEIKIN NO. R 39606 | TEIKIN NO. P 39606 | TEIKIN NO. B 39606 | TEIKIN NO. LFF 39606 | | |
| | REFERENCE NO. 1-12111-217-1 | REFERENCE NO. 1-12121-070-0 1-12121-075-0 1-12121-113-0 1-12121-750-0 | REFERENCE NO. | REFERENCE NO. 1-12251-016-0 1-12251-016-2 | REFERENCE NO. 1-11261-065-3 1-11261-094-1 | | |
| | 101 | | | | | | |

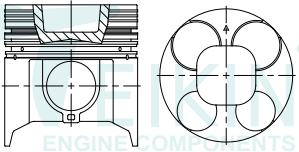
| ENGINE TYPE | PISTON | PISTON RING | PISTON PIN | PIN BUSHING | LINER | | LINER KIT SET |
|--|---|--|--|--|--|-----------|--|
| | | | | | FLANGED | NO FLANGE | |
| 6SA1-T 8413 cc 6 cyl. Surface Treatment: Tin Coated Bore Clearance: MRC: 0.000 mm, MP: 0.00 mm | \emptyset 115.00 -23.2 CD 67.8 TL 104.2 | 1 - 3.0 1 - 2.5 1 - 4.0 | \emptyset 38.000 TL 80.00 | | TL 216.0 OD 119.0 FT 6.0 FD 120.0 | | TEIKIN NO. LKFF 39615AG |
| | TEIKIN NO. 39615AG (39204) | TEIKIN NO. R 39606 | TEIKIN NO. P 39615 | TEIKIN NO. B 39606 | TEIKIN NO. LFF 39606 | | |
| | REFERENCE NO. 1-12111-459-1 | REFERENCE NO. 1-12121-070-0 1-12121-075-0 1-12121-113-0 1-12121-750-0 | REFERENCE NO. 1-12251-016-0 1-12251-016-2 | REFERENCE NO. 1-11261-065-3 1-11261-094-1 | | | |
| | | | | | | | 102 |
| PA1 9971 cc 10 cyl. Surface Treatment: Tin Coated Bore Clearance: MRC: 0.120 mm, MP: - mm | \emptyset 115.00 -24.1 CD 75.3 TL 113.3 | 1 - 3.0 1 - 2.5 1 - 6.0 | \emptyset 38.000 TL 80.00 | | TL 219.5 OD 130.0 FT 10.0 +1.2 FD 141.7 | | TEIKIN NO. LKFF 39662A |
| | TEIKIN NO. 39662A | TEIKIN NO. R 39662 | TEIKIN NO. P 39606 | TEIKIN NO. B 39625 | TEIKIN NO. LFF 39662 | | |
| | REFERENCE NO. 1-12111-154-1 | REFERENCE NO. 1-12121-042-0 1-12181-016-0 1-12181-060-0 | REFERENCE NO. 1-11251-001-0 | REFERENCE NO. 1-11261-063-0 | | | |
| | | | | | | | 103 |
| 10PC1 15014 cc 10 cyl. Surface Treatment: Tin Coated Bore Clearance: MRC: 0.140 mm, MP: 18.00 mm | \emptyset 119.00 -23.7 CD 67.7 TL 104.0 | 1 - 3.0 1 - 2.5 1 - 4.0 | \emptyset 38.000 TL 80.00 | | TL 219.5 OD 133.0 FT 10.0 +1.0 FD 143.7 | | TEIKIN NO. LKFF 39625 LKFF 39625A |
| | TEIKIN NO. 39625 39625A (39222) | TEIKIN NO. R 39625 | TEIKIN NO. P 39625 | TEIKIN NO. B 39625 | TEIKIN NO. LFF 39625 | | |
| | REFERENCE NO. 1-12111-419-2 | REFERENCE NO. 1-12121-047-0 1-12121-048-0 | REFERENCE NO. 1-12251-001-0 | REFERENCE NO. 1-11261-143-1 | | | |
| | | | | | | | 104 |
| 10PD1 16683 cc 10 cyl. Surface Treatment: Tin Coated Bore Clearance: MRC: 0.130 mm, MP: 20.00 mm | \emptyset 119.00 -25.0 CD 67.6 TL 106.6 | 1 - 4.0 1 - 2.5 1 - 4.0 | \emptyset 43.000 TL 80.00 | | TL 234.0 OD 133.0 FT 10.1 FD 143.6 | | TEIKIN NO. LKFF 39626 LKFF 39626A |
| | TEIKIN NO. 39626 39626A (39223) | TEIKIN NO. R 39626 | TEIKIN NO. P 39626 | TEIKIN NO. B 39626 | TEIKIN NO. LFF 39626 | | |
| | REFERENCE NO. 1-12111-549-3 | REFERENCE NO. 1-12121-062-0 1-12121-063-0 | REFERENCE NO. 1-12251-033-0 | REFERENCE NO. | | | |
| | | | | | | | 105 |

| ENGINE TYPE | PISTON | PISTON RING | PISTON PIN | PIN BUSHING | LINER | | LINER KIT SET |
|---|---|--|--|--|--|-----------|--|
| | | | | | FLANGED | NO FLANGE | |
| 6SD1 9839 cc 6 cyl.  Surface Treatment Tin Coated Bore Clearance MRC: 0.110 mm MP: 30.00 mm | \emptyset 120.00 -24.7 CD 75.0 TL 117.0 | 1 - 3.5 1 - 2.5 1 - 5.0 | \emptyset 43.000 TL 89.50  | | TL 239.0 OD 123.0 FT 6.0 +1.0 FD 129.6 | | TEIKIN NO. LKFF 39623 LKFF 39623A |
| | TEIKIN NO. 39623 39623A (39220) | TEIKIN NO. R 39623 | TEIKIN NO. P 39623 | TEIKIN NO. B 39623 | TEIKIN NO. LFF 39623 | | |
| | REFERENCE NO. 1-12111-569-0 | REFERENCE NO. 1-12121-094-1 | REFERENCE NO. 1-12251-021-0 1-12251-021-1 | REFERENCE NO. 1-11261-106-2 1-11261-298-0 | | | |
| | 106 | | | | | | |
| DH 100 10179 cc 6 cyl.  Surface Treatment Bore Clearance MRC: - mm MP: - mm | \emptyset 120.00 -8.3 CD 77.8 TL 150.8 | 3 - 3.0 1 - 6.0 | \emptyset 45.000 TL 97.50 | | TL 280.0 OD 135.0 FT 11.0 FD 140.6 | | TEIKIN NO. LKFF 39617 |
| | TEIKIN NO. 39617 (39207) | TEIKIN NO. R 39617 | TEIKIN NO. P 39617 | TEIKIN NO. B 39617 | TEIKIN NO. LFF 39617 | | |
| | REFERENCE NO. 9-12111-742-0 9-12111-849-1 | REFERENCE NO. 1-12121-016-0 1-12121-001-0 9-12181-083-0 9-12181-086-0 | REFERENCE NO. 9-12251-069-0 9-12251-070-0 | REFERENCE NO. 9-11261-241-0 9-11261-270-0 | | | |
| | 107 | | | | | | |
| 6QA1 11044 cc 6 cyl.  Surface Treatment Tin Coated Bore Clearance MRC: 0.160 mm MP: 10.00 mm | \emptyset 125.00 -25.6 CD 83.2 TL 136.0 | 1 - 3.0 1 - 2.5 1 - 6.0 | \emptyset 46.000 TL 106.00  | | TL 282.0 OD 140.0 FT 11.0 +2.0 FD 146.7 | | TEIKIN NO. LKFF 39657A |
| | TEIKIN NO. 39657A | TEIKIN NO. R 39657 | TEIKIN NO. P 39657 | TEIKIN NO. B 39657 | TEIKIN NO. LFF 39657 | | |
| | REFERENCE NO. 1-12111-338-0 | REFERENCE NO. 1-12121-028 1-12121-046 | REFERENCE NO. 9-12251-073-0 9-12251-074-1 | REFERENCE NO. 1-11261-074-0 1-11261-061-1 | | | |
| | 108 | | | | | | |
| 6RB1 13741 cc 6 cyl.  Surface Treatment Tin Coated Bore Clearance MRC: 0.170 mm MP: 20.00 mm | \emptyset 135.00 -27.7 CD 82.2 TL 143.1 | 1 - 4.0 1 - 2.5 1 - 5.0 | \emptyset 50.000 TL 105.00  | | TL 264.0 OD 141.0 FT 6.0 FD 146.7 | | TEIKIN NO. LKFF 39624 LKFF 39624A |
| | TEIKIN NO. 39624 39624A (39221) | TEIKIN NO. R 39624 | TEIKIN NO. P 39624 | TEIKIN NO. B 39624 | TEIKIN NO. LFF 39624 | | |
| | REFERENCE NO. 1-12111-245-0 1-12111-437-0 | REFERENCE NO. 1-12121-037-0 1-12121-040-0 | REFERENCE NO. 9-12251-088-0 | REFERENCE NO. 1-11261-082-0 1-11261-098-0 1-11261-133-0 1-11261-105-1 | | | |
| | 109 | | | | | | |

SUITABLE FOR

JEEP WILLYS

GASOLINE

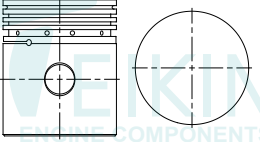
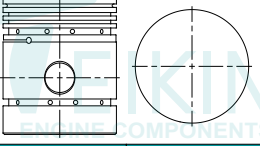

| ENGINE TYPE | PISTON | PISTON RING | PISTON PIN | PIN BUSHING | LINER | | LINER KIT SET |
|--|--|-------------------------------|----------------------------------|-------------|---------|-----------|---------------|
| | | | | | FLANGED | NO FLANGE | |
| 88 ANP 4 cyl.  | \varnothing 79.38 CD 55.7 TL 95.1 | 3 - 2.4 1 - 4.8 | \varnothing 20.625 TL 70.60 | | | | TEIKIN NO. |
| Surface Treatment Bore Clearance Tin Coated MRC: 0.070 mm MP: 10.00 mm | TEIKIN NO. 47101 REFERENCE NO. 88ANP | | TEIKIN NO. P 47101 | | | | 1 |
| 488 ANP 4 cyl.  | \varnothing 79.38 CD 55.7 TL 95.1 | 1 - 2.0 2 - 2.4 2 - 4.8 | \varnothing 20.625 TL 70.60 | | | | TEIKIN NO. |
| Surface Treatment Bore Clearance Tin Coated MRC: 0.070 mm MP: 10.00 mm | TEIKIN NO. 47102 REFERENCE NO. 488ANP | | TEIKIN NO. P 47101 | | | | 2 |

J

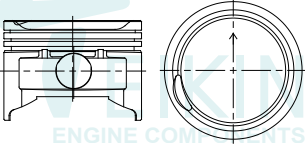
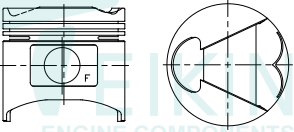
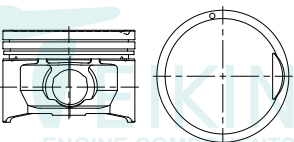
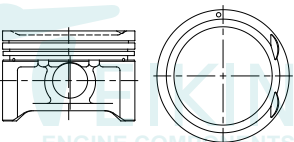
| ENGINE TYPE | PISTON | PISTON RING | PISTON PIN | PIN BUSHING | LINER | | LINER KIT SET | | |
|--|--|---|----------------------------------|-------------|---------|-----------|--|---|--|
| | | | | | FLANGED | NO FLANGE | | | |
| PICANTO 4 cyl.  | \varnothing 67.00 -4.3 CD 24.6 TL 48.6 | 2 - 1.2 1 - 2.0 | \varnothing 17.000 TL 46.50 | | | | TEIKIN NO. REFERENCE NO. 23410-02270 23410-02470 23410-02230 | 1 | |
| | TEIKIN NO. 52106 | TEIKIN NO. P 51117 | | | | | | | |
| | Surface Treatment None | Bore Clearance MRC: 0.030 mm MP: 13.00 mm | | | | | | | |
| | | | | | | | | | |
| B1 PRIDE 1.1L 4 cyl.  | \varnothing 68.00 +0.6 CD 31.9 TL 63.6 | 1 - 1.2 1 - 1.5 1 - 3.0 | \varnothing 19.980 TL 52.00 | | | | TEIKIN NO. REFERENCE NO. KKY18-11-SA0 | 2 | |
| | TEIKIN NO. 52110 | TEIKIN NO. P 52110 | | | | | | | |
| | Surface Treatment None | Bore Clearance MRC: 0.030 mm MP: 15.75 mm | | | | | | | |
| | | | | | | | | | |
| A3E RIO 2000-2005 4 cyl.  | \varnothing 75.50 -0.6 CD 32.5 TL 52.6 | 2 - 1.2 1 - 2.5 | \varnothing 19.980 TL 52.00 | | | | TEIKIN NO. REFERENCE NO. 0K3Y-11-5A0 0K3Y0-11-5A0 0K3Y0-11-SA0 0K3Y0-11-SB0 | 3 | |
| | TEIKIN NO. 52654 | TEIKIN NO. P 52110 | | | | | | | |
| | Surface Treatment Tin Coated | Bore Clearance MRC: 0.030 mm MP: 6.00 mm | | | | | | | |
| | | | | | | | | | |
| DC RIO F.I., SOHC 16V 2001-02 4 cyl.  | \varnothing 75.50 -2.3 CD 28.3 TL 51.3 | 2 - 1.2 1 - 2.5 | \varnothing 19.980 TL 52.00 | | | | TEIKIN NO. REFERENCE NO. 0K3Y2-11-SA0 | 4 | |
| | TEIKIN NO. 52102 | TEIKIN NO. P 52110 | | | | | | | |
| | Surface Treatment None | Bore Clearance MRC: 0.030 mm MP: 7.50 mm | | | | | | | |
| | | | | | | | | | |

K

SUITABLE FOR





KIA

GASOLINE

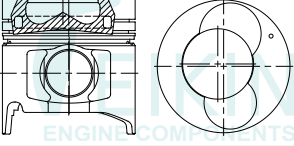

| ENGINE TYPE | PISTON | PISTON RING | PISTON PIN | PIN BUSHING | LINER | | LINER KIT SET |
|---|---|---|--------------------------------|-------------|---------|-----------|---------------|
| | | | | | FLANGED | NO FLANGE | |
| B6D DOHC 1500 cc 4 cyl. | \emptyset 78.00 +0.6 CD 31.3 TL 63.0 | 2 - 1.5 1 - 3.0 | \emptyset 19.980 TL 65.00 | | | | TEIKIN NO. |
| | TEIKIN NO. 52103 | | TEIKIN NO. P 42146 | | | | |
| Surface Treatment None | Bore Clearance MRC: 0.030 mm MP: 15.50 mm | REFERENCE NO. K2Y0-11-SAO | | | | | 5 |
| RIO 1.6L RIO 1.6L 2003-2005 DOHC 16V RIO-CINCO RIO-RX-V 1594 cc 4 cyl. | \emptyset 78.00 -0.8 CD 28.3 TL 48.3 | 2 - 1.2 1 - 2.5 | \emptyset 19.980 TL 52.00 | | | | TEIKIN NO. |
| | TEIKIN NO. 52111 | | TEIKIN NO. P 52110 | | | | |
| Surface Treatment None | Bore Clearance MRC: 0.030 mm MP: 6.00 mm | REFERENCE NO. 23410-2X710 23410-2X905/6 | | | | | 6 |
| SEPHIA-II 4 cyl. | \emptyset 78.00 +1.0 CD 31.4 TL 63.5 | 2 - 1.5 1 - 3.0 | \emptyset 19.980 TL 61.00 | | | | TEIKIN NO. |
| | TEIKIN NO. 52113 | | TEIKIN NO. P 42173 | | | | |
| Surface Treatment None | Bore Clearance MRC: 0.030 mm MP: 15.50 mm | REFERENCE NO. 0K2Y3-11-103 | | | | | 7 |
| CARNIVAL SEDONA 6 cyl. | \emptyset 80.00 -1.3 CD 27.3 TL 50.3 | 1 - 1.2 1 - 1.5 1 - 2.5 | \emptyset 18.000 TL 53.00 | | | | TEIKIN NO. |
| | TEIKIN NO. 52105 | | TEIKIN NO. P 46332 | | | | |
| Surface Treatment Tin Coated | Bore Clearance MRC: 0.030 mm MP: 9.00 mm | REFERENCE NO. 0K9YV-11-SAO | | | | | 8 |

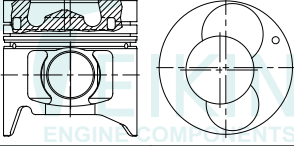
| ENGINE TYPE | PISTON | PISTON RING | PISTON PIN | PIN BUSHING | LINER | | | LINER KIT SET |
|--|--|---|------------------------------------|--------------------------------------|--|-------------------------------------|----------------|---|
| | | | | | FLANGED | NO FLANGE | | |
| RFA 2700 cc HI - BESTA 4 cyl. | \emptyset 93.00 -2.85 CD 48.2 TL 85.2 | 2 - 2.0 1 - 3.0 | \emptyset 30.00 TL 75.00 | | TL OD FT FD | 167.5 96.8 2.5 +0.5 102.2 | | TEIKIN NO. LKFF 52650A LKFF 52650AG LKSF 52650A LKSF 52650AG |
| Surface Treatment: Tin Coated Bore Clearance: MRC: 0.030 mm MP: 14.50 mm | TEIKIN NO. 52650A 52650AG | TEIKIN NO. R 52650 | TEIKIN NO. P 52650 | TEIKIN NO. B 52650 | TEIKIN NO. LFF 52650 LSF 52650 | | | 12 |
| | REFERENCE NO. VNY1-11-SAO | REFERENCE NO. 0VNY1-11-SCO VNY1-11-SCO | | REFERENCE NO. | REFERENCE NO. OVN01-10-311 VN01-10-311 | | | |
| CARNIVAL-II 2902 cc SEDONA K2900 4 cyl. | \emptyset 97.10 -17.8 CD 52.0 TL 84.0 | 1 - 2.0 HK 1 - 2.0 1 - 3.0 | \emptyset 32.00 TL 78.00 | | TL OD FT FD | 168.0 101.5 2.5 +0.7 106.0 | 168.0 101.2 | TEIKIN NO. LKFF 52107AG LKSF 52107AG LKXS 52107AG |
| Surface Treatment: Tin Coated Moly Skirt Bore Clearance: MRC: 0.050 mm MP: 10.50 mm | TEIKIN NO. 52107AG | TEIKIN NO. R 52107 | TEIKIN NO. P 52107 | TEIKIN NO. B 52107 | TEIKIN NO. LFF 52107 LSF 52107 LSX 52107 | | | 13 |
| | REFERENCE NO. 0K5Z1-11-SAO | REFERENCE NO. K5Z1-11-SCO 0K5Z1-11-SCO | | REFERENCE NO. | REFERENCE NO. 0K551-10-311 0K551-10-311A | | | |
| JT3.0 3000 cc PREGIO 3.0 4 cyl. | \emptyset 98.00 -4.7 CD 45.5 TL 76.1 | 2 - 2.0 1 - 3.0 | \emptyset 30.00 TL 78.00 | | TL OD FT FD | 166.2 101.5 2.5 +0.7 107.0 | | TEIKIN NO. LKFF 52651A LKFF 52651AG LKSF 52651A LKSF 52651AG |
| Surface Treatment: Moly Skirt Bore Clearance: MRC: 0.030 mm MP: 8.25 mm | TEIKIN NO. 52651A 52651AG | TEIKIN NO. R 52651 | TEIKIN NO. P 43232 | TEIKIN NO. B 52651 | TEIKIN NO. LFF 52651 LSF 52651 | | | 14 |
| | REFERENCE NO. K7Z1-11-SAO | REFERENCE NO. K7Z1-11-SCO 0K7Z1-11-SCO | | REFERENCE NO. 0SE01-11-213 | REFERENCE NO. K75A-10-311 OK75A-10-311 OK75A-10-311B OK75B-10-311 | | | |
| JD K3500 3455 cc 4 cyl. | \emptyset 100.00 -18.0 CD 58.0 TL 105.0 | 1 - 2.5 1 - 2.0 1 - 4.5 | \emptyset 34.000 TL 82.00 | | TL OD FT FD | 193.5 103.5 2.5 +0.8 108.0 | | TEIKIN NO. LKFF 52652A LKSF 52652A |
| Surface Treatment: Tin Coated Bore Clearance: MRC: 0.050 mm MP: 15.00 mm | TEIKIN NO. 52652A | TEIKIN NO. R 52652 | TEIKIN NO. P 52652 | TEIKIN NO. B 52652 | TEIKIN NO. LFF 52652 LSF 52652 | | | 15 |
| | REFERENCE NO. K4Y0-11-SAO | REFERENCE NO. K4Y0-11-SCO | | REFERENCE NO. 0K410-11-213 | REFERENCE NO. OK410-10-311B SL01-23-051 | | | |

| ENGINE TYPE | PISTON | PISTON RING | PISTON PIN | PIN BUSHING | LINER | | LINER KIT SET |
|--|---|---|---|--------------------------------------|--|-----------|---|
| | | | | | FLANGED | NO FLANGE | |
| SH K3600 3598 cc 4 cyl.  Surface Treatment Tin Coated Moly Skirt Bore Clearance MRC: 0.050 mm MP: 19.00 mm | \emptyset 100.00 -20.0 CD 56.2 TL 102.0 | 2 - 2.0 1 - 3.0 | \emptyset 34.000 TL 82.00  | | TL 193.5 OD 103.5 FT 2.5 +0.8 FD 108.0 | | TEIKIN NO. LKFF 52653G LKSF 52653G |
| | TEIKIN NO. | TEIKIN NO. | TEIKIN NO. | TEIKIN NO. | TEIKIN NO. | | |
| | 52653G | R 52653 | P 42107 | B 52652 | LFF 52652 LSF 52652 | | |
| | REFERENCE NO. K4Y1-11-SAO OK4Y1-11-SAO | REFERENCE NO. K4Y1-11-SCO OK4Y1-11-SCO | | REFERENCE NO. OK410-11-213 | REFERENCE NO. OK410-10-311B SL01-23-051 | | |
| SH K3600 NEW-II 3600 cc 4 cyl.  Surface Treatment Tin Coated Moly Skirt Bore Clearance MRC: 0.050 mm MP: 19.00 mm | \emptyset 100.00 -20.0 CD 56.2 TL 102.0 | 2 - 2.0 1 - 3.0 | \emptyset 34.000 TL 82.00  | | TL 193.5 OD 103.5 FT 2.5 +0.8 FD 108.0 | | TEIKIN NO. LKFF 52656G LKSF 52656G |
| | TEIKIN NO. | TEIKIN NO. | TEIKIN NO. | TEIKIN NO. | TEIKIN NO. | | |
| | 52656G | R 52653 | P 42107 | B 52652 | LFF 52652 LSF 52652 | | |
| | REFERENCE NO. K47A-11-102 | REFERENCE NO. K4Y1-11-SCO OK4Y1-11-SCO | | REFERENCE NO. OK410-11-213 | REFERENCE NO. OK410-10-311B SL01-23-051 | | |

K

| ENGINE TYPE | PISTON | PISTON RING | PISTON PIN | PIN BUSHING | LINER | | LINER KIT SET |
|--|---|--|--|--|--|-----------|--|
| | | | | | FLANGED | NO FLANGE | |
| 4D95 3260 cc 4 cyl. Surface Treatment: None Bore Clearance: MRC: 0.050 mm, MP: 22.00 mm | \emptyset 95.00 -19.8 CD 51.0 TL 94.0 | 2 - 2.0 1 - 4.0 | \emptyset 30.000 TL 74.00 | | TL 180.0 OD 98.0 FT 4.0 FD 104.0 | | TEIKIN NO. LKFF 64601 LKFF 64601A 1 |
| | TEIKIN NO. 64601 64601A | TEIKIN NO. R 64601 | TEIKIN NO. P 44666 | TEIKIN NO. B 64601 | TEIKIN NO. LFF 64601 | | |
| | REFERENCE NO. 6204-31-2121 | REFERENCE NO. 6204-31-2200 6204-31-2203 | REFERENCE NO. 6204-31-3130 6206-31-3130 6207-31-3130 | REFERENCE NO. 6207-21-2110 6207-21-2120 6207-21-2121 | | | |
| | | | | | | | |
| | | | | | | | |
| 4D105 4326 cc 4 cyl. Surface Treatment: None Bore Clearance: MRC: 0.140 mm, MP: 15.00 mm | \emptyset 105.00 -22.7 CD 69.0 TL 107.5 | 1 - 3.0 1 - 2.5 1 - 5.0 | \emptyset 40.000 TL 84.00 | | TL 223.0 OD 118.7 FT 10.0 +1.0 FD 127.0 | | TEIKIN NO. LKFF 64602A 2 |
| | TEIKIN NO. 64602A | TEIKIN NO. R 64602 | TEIKIN NO. P 64602 | TEIKIN NO. B 64602 | TEIKIN NO. LFF 64602 | | |
| | REFERENCE NO. 6136-31-2012 6136-31-2112 | REFERENCE NO. 6130-31-2202 6130-32-2202 6130-32-2301 6130-32-2302 | REFERENCE NO. 6136-31-3130 | REFERENCE NO. 6136-21-2210 6137-21-2210 6137-22-2210 | | | |
| | | | | | | | |
| | | | | | | | |

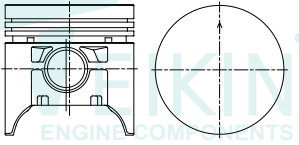
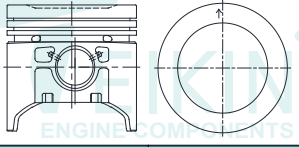
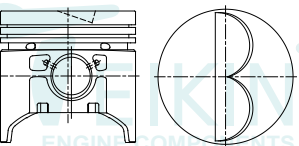
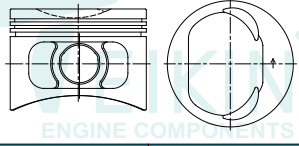



| ENGINE TYPE | PISTON | PISTON RING | PISTON PIN | PIN BUSHING | LINER | | LINER KIT SET |
|---|--|-------------------------------|----------------------------------|-------------|---------|-----------|---------------|
| | | | | | FLANGED | NO FLANGE | |
| 2101 4 cyl. | \varnothing 76.00 CD 37.9 TL 76.9 | 1 - 1.5 1 - 2.0 1 - 4.0 | \varnothing 21.982 TL 67.00 | | | | TEIKIN NO. |
|  | TEIKIN NO. 59101 | | TEIKIN NO. P 59101 | | | | |
| Surface Treatment Moly Skirt | Bore Clearance MRC: 0.030 mm MP: 20.00 mm | | | | | | |
| | | | | | | | 1 |
| 21011 4 cyl. | \varnothing 79.00 CD 37.9 TL 76.9 | 1 - 1.5 1 - 2.0 1 - 4.0 | \varnothing 21.982 TL 67.00 | | | | TEIKIN NO. |
|  | TEIKIN NO. 59103 | | TEIKIN NO. P 59101 | | | | |
| Surface Treatment Tin Coated | Bore Clearance MRC: 0.030 mm MP: 20.00 mm | | | | | | |
| | | | | | | | 2 |
| VAZ 2105 4 cyl. | \varnothing 79.00 CD 38.0 TL 76.9 | 1 - 1.5 1 - 2.0 1 - 4.0 | \varnothing 21.982 TL 67.00 | | | | TEIKIN NO. |
|  | TEIKIN NO. 59109 | | TEIKIN NO. P 59101 | | | | |
| Surface Treatment Chromated | Bore Clearance MRC: 0.030 mm MP: 20.00 mm | | | | | | |
| | | | | | | | 3 |
| 2110 4 cyl. | \varnothing 82.00 CD 37.9 TL 65.9 | 1 - 1.5 1 - 2.0 1 - 4.0 | \varnothing 21.982 TL 60.00 | | | | TEIKIN NO. |
|  | TEIKIN NO. 59106 | | TEIKIN NO. P 59106 | | | | |
| Surface Treatment Moly Skirt | Bore Clearance MRC: 0.030 mm MP: 12.50 mm | | | | | | |
| | | | | | | | 4 |

SUITABLE FOR

LADA

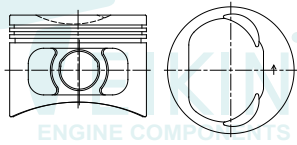
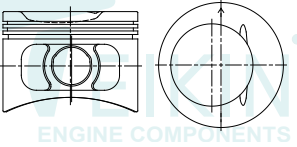
GASOLINE

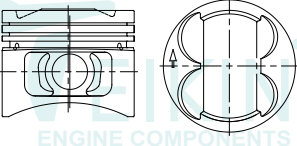

| ENGINE TYPE | PISTON | PISTON RING | PISTON PIN | PIN BUSHING | LINER | | LINER KIT SET |
|--|---|-------------------------------|---|-------------|---------|-----------|---------------|
| | | | | | FLANGED | NO FLANGE | |
| 21083 4 cyl.  ENGINE COMPONENTS Surface Treatment Bore Clearance Moly Skirt MRC: 0.030 mm MP: 12.50 mm | \varnothing 82.00 -6.54 CD 37.9 TL 65.9 | 1 - 1.5 1 - 2.0 1 - 4.0 | \varnothing 21.982 TL 67.00 | | | | TEIKIN NO. |
| | TEIKIN NO. 59105 | | TEIKIN NO. P 59101 | | | | |
| | REFERENCE NO. | | | | | | |
| | | | | | | | 5 |
| 21213 4 cyl.  ENGINE COMPONENTS Surface Treatment Bore Clearance Moly Skirt MRC: 0.030 mm MP: 12.00 mm | \varnothing 82.00 -7.30 CD 37.9 TL 65.9 | 1 - 1.5 1 - 2.0 1 - 4.0 | \varnothing 21.982 TL 67.00  | | | | TEIKIN NO. |
| | TEIKIN NO. 59108 | | TEIKIN NO. P 59101 | | | | |
| | REFERENCE NO. | | | | | | |
| | | | | | | | 6 |
| VAZ 2112 4 cyl.  ENGINE COMPONENTS Surface Treatment Bore Clearance Tin Coated MRC: 0.030 mm MP: 10.50 mm | \varnothing 82.00 +0.90 CD 38.0 TL 66.8 | 1 - 1.5 1 - 2.0 1 - 4.0 | \varnothing 21.982 TL 60.00  | | | | TEIKIN NO. |
| | TEIKIN NO. 59107 | | TEIKIN NO. P 59106 | | | | |
| | REFERENCE NO. KS : 99 753 600 | | | | | | |
| | | | | | | | 7 |

SUITABLE FOR

LEYLAND

DIESEL

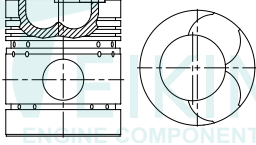

| ENGINE TYPE | PISTON | PISTON RING | PISTON PIN | PIN BUSHING | LINER | | LINER KIT SET |
|--|--|-------------------------------|---|-------------|---------|-----------|---|
| | | | | | FLANGED | NO FLANGE | |
| 4.98 NV 3770 cc FG / TERRIER SERIES TRACTORS 262, 272, 470, 472, 462 4 cyl. | \varnothing 98.00 -25.0 CD 68.3 TL 116.3 | 3 - 2.4 1 - 6.4 1 - 4.8 | \varnothing 34.925 TL 82.50  | | | | TEIKIN NO. 50101 REFERENCE NO. AE 350236 |
|  | | | | | | | TEIKIN NO. P 50101 |
| Surface Treatment None | Bore Clearance MRC: 0.150 mm MP: 22.00 mm | | | | | | 1 |

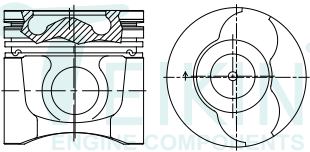

| ENGINE TYPE | PISTON | PISTON RING | PISTON PIN | PIN BUSHING | LINER | | LINER KIT SET |
|---|---|-------------------------------------|---|------------------------------|---|-----------|--|
| | | | | | FLANGED | NO FLANGE | |
| SCORPIO CRD 4 cyl. | \varnothing 94.00 -16.5 CD 54.1 TL 90.1 | 1 - 3.0 FK 1 - 2.5 1 - 4.0 | \varnothing 32.000 TL 76.00  | | TL 176.7 OD 111.0 FT 9.0 +1.0 FD 115.0 | | TEIKIN NO. LKFF 66101A |
|  | TEIKIN NO. 66101A | TEIKIN NO. R 66101 | TEIKIN NO. P 46613 | TEIKIN NO. B 66101 | TEIKIN NO. LFF 66101 | | <div style="border: 1px solid black; width: 20px; height: 20px; text-align: center; margin: 0 auto;">1</div> |
| Surface Treatment Chromated | Bore Clearance MRC: 0.060 mm MP: 11.00 mm | REFERENCE NO. 0312BC0181N | REFERENCE NO. | REFERENCE NO. | REFERENCE NO. | | |









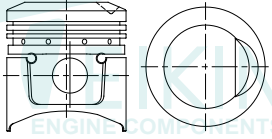

SUITABLE FOR

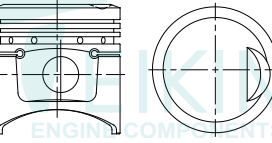
MAZDA

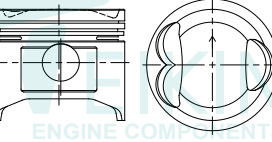
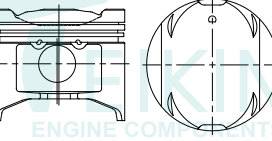
GASOLINE

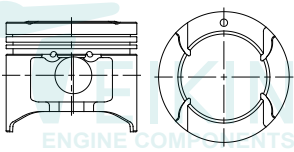
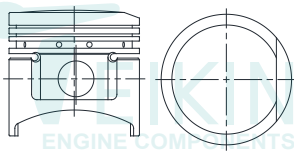

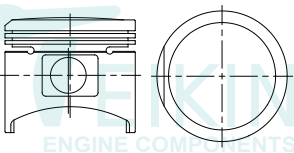
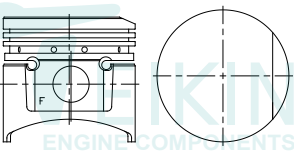
| ENGINE TYPE | PISTON | PISTON RING | PISTON PIN | PIN BUSHING | LINER | | LINER KIT SET | |
|---|--|-------------------------------|---|-------------|---------|-----------|--|--|
| | | | | | FLANGED | NO FLANGE | | |
| PB 987 cc 4 cyl. 1967 FAMILIA  Surface Treatment Bore Clearance Tin Coated MRC: 0.030 mm MP: 13.35 mm | \emptyset 68.00 +4.0 CD 41.8 TL 73.5 | 2 - 2.0 1 - 4.0 | \emptyset 20.000 TL 55.00  | | | | TEIKIN NO. REFERENCE NO. 0249-99-111 0259-23-200 0249-11-102 1 | |
| | TEIKIN NO. 42108 | TEIKIN NO. P 42108 | | | | | | |
| | | | | | | | | |
| | | | | | | | | |
| TB 1139 cc 4 cyl.  Surface Treatment Bore Clearance Tin Coated MRC: 0.060 mm MP: 15.50 mm | \emptyset 70.00 +2.0 CD 39.0 TL 71.0 | 2 - 2.0 1 - 4.0 | \emptyset 19.980 TL 56.00  | | | | TEIKIN NO. REFERENCE NO. 0268-23-200 0268-11-102 0271-23-200 2 | |
| | TEIKIN NO. 42656 | TEIKIN NO. P 42656 | | | | | | |
| | | | | | | | | |
| | | | | | | | | |
| B3 1323 cc 4 cyl. 323 1.3L SEDAN 1989-ON KIA PRIDE  Surface Treatment Bore Clearance Tin Coated MRC: 0.030 mm MP: 13.50 mm | \emptyset 71.00 -1.2 CD 28.8 TL 60.0 | 1 - 1.2 1 - 1.5 1 - 3.0 | \emptyset 20.000 TL 52.00 | | | | TEIKIN NO. REFERENCE NO. B3Y0-11-SA0 KK1Y0-11-SAO B315-11-102 3 | |
| | TEIKIN NO. 42127 | TEIKIN NO. P G2101 | | | | | | |
| | | | | | | | | |
| | | | | | | | | |
| B3-II 1323 cc 4 cyl.  Surface Treatment Bore Clearance Tin Coated MRC: 0.030 mm MP: 14.00 mm | \emptyset 71.00 -8.80 CD 29.4 TL 60.0 | 1 - 1.2 1 - 1.5 1 - 3.0 | \emptyset 20.000 TL 52.00 | | | | TEIKIN NO. REFERENCE NO. B3C7-11-102 B3Y6-11-SAOB B3Y6-11-SAO 4 | |
| | TEIKIN NO. 42660 | TEIKIN NO. P G2101 | | | | | | |
| | | | | | | | | |
| | | | | | | | | |

| ENGINE TYPE | PISTON | PISTON RING | PISTON PIN | PIN BUSHING | LINER | | LINER KIT SET |
|--|--|-------------------------------|---|-------------|---------|-----------|-----------------------------------|
| | | | | | FLANGED | NO FLANGE | |
| B3-III 4 cyl.  | \emptyset 71.00 +0.5 CD 28.8 TL 60.0 | 1 - 1.2 1 - 1.5 1 - 3.0 | \emptyset 19.980 TL 52.00 | | | | TEIKIN NO. 5 |
| | TEIKIN NO. 42217 | | TEIKIN NO. P 52110 | | | | |
| | REFERENCE NO. B3Z0-11-SA0 | | | | | | |
| | Surface Treatment None Bore Clearance MRC: 0.030 mm MP: 13.50 mm | | | | | | |
| TC 1272 cc 4 cyl.  | \emptyset 73.00 +1.4 CD 37.1 TL 70.4 | 2 - 2.0 1 - 4.0 | \emptyset 20.000 TL 55.00  | | | | TEIKIN NO. 6 |
| | TEIKIN NO. 42651 | | TEIKIN NO. P 42108 | | | | |
| | REFERENCE NO. 0370-23-200 0370-99-111 | | | | | | |
| | Surface Treatment Tin Coated Bore Clearance MRC: 0.030 mm MP: 14.75 mm | | | | | | |
| TC LATE 1272 cc 4 cyl.  | \emptyset 73.00 +1.3 CD 31.0 TL 64.3 | 2 - 1.5 1 - 4.0 | \emptyset 20.000 TL 65.00 | | | | TEIKIN NO. 7 |
| | TEIKIN NO. 42607 (42182) | | TEIKIN NO. P 56101 | | | | |
| | REFERENCE NO. 8034-23-200 | | | | | | |
| | Surface Treatment Tin Coated Bore Clearance MRC: 0.030 mm MP: 18.00 mm | | | | | | |
| TC-II 1272 cc 4 cyl.  | \emptyset 73.00 CD 37.1 TL 69.0 | 2 - 2.0 1 - 4.0 | \emptyset 20.000 TL 55.00  | | | | TEIKIN NO. 8 |
| | TEIKIN NO. 42670 | | TEIKIN NO. P 42108 | | | | |
| | REFERENCE NO. 0324-23-200 0324-99-111 | | | | | | |
| | Surface Treatment Tin Coated Bore Clearance MRC: 0.030 mm MP: 14.75 mm | | | | | | |

M

| ENGINE TYPE | PISTON | PISTON RING | PISTON PIN | PIN BUSHING | LINER | | LINER KIT SET |
|---|---|-------------------------------|--------------------------------|-------------|---------|-----------|---------------|
| | | | | | FLANGED | NO FLANGE | |
| Z5 1489 cc 4 cyl. PROTEGE F.I; DOHC 4, 16V 1995-98 | \emptyset 75.30 -6.30 CD 28.1 TL 51.8 | 1 - 1.0 1 - 1.2 1 - 2.5 | \emptyset 19.980 TL 61.00 | | | | TEIKIN NO. |
| | TEIKIN NO. | | TEIKIN NO. | | | | |
| | 42173 | | P 42173 | | | | |
| | REFERENCE NO. Z5Y0-11-SAO Z5Y0-11-SAOB | | | | | | |
| Surface Treatment Bore Clearance Tin Coated MRC: 0.020 mm MP: 12.00 mm | | | | | | | 9 |
| E3 1296 cc 4 cyl. E5 OLD 1983 | \emptyset 77.00 +0.8 CD 29.0 TL 61.7 | 1 - 1.5 1 - 2.0 1 - 4.0 | \emptyset 19.980 TL 65.00 | | | | TEIKIN NO. |
| | TEIKIN NO. | | TEIKIN NO. | | | | |
| | 42131 | | P 42146 | | | | |
| | REFERENCE NO. E302-23-200/A E302-11-102A | | | | | | |
| Surface Treatment Bore Clearance None MRC: 0.030 mm MP: 15.50 mm | | | | | | | 10 |
| E3-II 1296 cc 4 cyl. | \emptyset 77.00 +0.8 CD 29.0 TL 61.8 | 1 - 1.2 1 - 1.5 1 - 4.0 | \emptyset 19.990 TL 65.00 | | | | TEIKIN NO. |
| | TEIKIN NO. | | TEIKIN NO. | | | | |
| | 42652 | | P 42600 | | | | |
| | REFERENCE NO. E301-23-200 | | | | | | |
| Surface Treatment Bore Clearance Tin Coated MRC: 0.020 mm MP: 9.50 mm | | | | | | | 11 |
| E5 NEW 1490 cc 4 cyl. 1980 BONGO LASER | \emptyset 77.00 -2.5 CD 29.0 TL 61.0 | 1 - 1.2 1 - 1.5 1 - 4.0 | \emptyset 20.000 TL 66.00 | | | | TEIKIN NO. |
| | TEIKIN NO. | | TEIKIN NO. | | | | |
| | 42132 | | P 46187 | | | | |
| | REFERENCE NO. E501-23-200 | | | | | | |
| Surface Treatment Bore Clearance Chromated MRC: 0.030 mm MP: 16.00 mm | | | | | | | 12 |

M

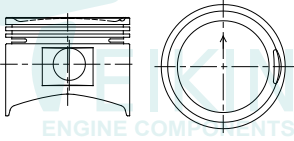
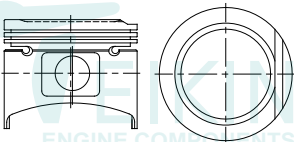
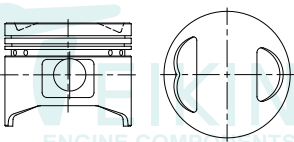
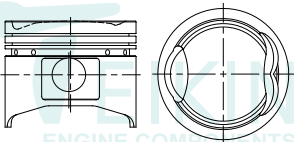
| ENGINE TYPE | PISTON | PISTON RING | PISTON PIN | PIN BUSHING | LINER | | LINER KIT SET |
|--|--|-------------------------------|--------------------------------|-------------|---------|-----------|---|
| | | | | | FLANGED | NO FLANGE | |
| E5-II 1490 cc 4 cyl.  Surface Treatment Tin Coated Bore Clearance MRC: 0.030 mm MP: 16.00 mm | \emptyset 77.00 -2.5 CD 29.0 TL 61.0 | 1 - 1.5 1 - 2.0 1 - 4.0 | \emptyset 19.980 TL 65.00 | | | | TEIKIN NO. REFERENCE NO. E502-23-200A E502-23-200 E502-11-102A 13 |
| | TEIKIN NO. 42196 | | TEIKIN NO. P 42146 | | | | |
| | | | | | | | |
| | | | | | | | |
| UC 1415 cc 4 cyl.  Surface Treatment Tin Coated Bore Clearance MRC: 0.030 mm MP: 18.00 mm | \emptyset 77.00 -1.2 CD 31.0 TL 63.0 | 2 - 1.5 1 - 4.0 | \emptyset 19.990 TL 65.00 | | | | TEIKIN NO. REFERENCE NO. 8569-23-200 14 |
| | TEIKIN NO. 42600 (42187) | | TEIKIN NO. P 42600 | | | | |
| | | | | | | | |
| | | | | | | | |
| B5 1498 cc 4 cyl.  Surface Treatment Tin Coated Bore Clearance MRC: 0.030 mm MP: 14.50 mm | \emptyset 78.00 -6.2 CD 31.9 TL 63.5 | 2 - 1.5 1 - 4.0 | \emptyset 19.980 TL 61.00 | | | | TEIKIN NO. REFERENCE NO. B505-11-102B B5Y5-11-A0A B5Y1-11-SA0 15 |
| | TEIKIN NO. 42653 | | TEIKIN NO. P 42173 | | | | |
| | | | | | | | |
| | | | | | | | |
| B6 1597 cc 4 cyl. 323 F.I ; SOHC 4 1986 - 87  Surface Treatment Tin Coated Bore Clearance MRC: 0.020 mm MP: 14.50 mm | \emptyset 78.00 -2.0 CD 31.9 TL 63.0 | 2 - 1.5 1 - 4.0 | \emptyset 19.980 TL 65.00 | | | | TEIKIN NO. REFERENCE NO. B6Y0-11-SA0 B6Y0-11-SA0A B630-11-102 16 |
| | TEIKIN NO. 42171 | | TEIKIN NO. P 42146 | | | | |
| | | | | | | | |
| | | | | | | | |

M

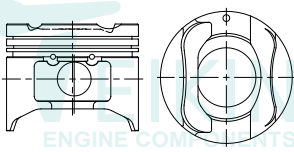
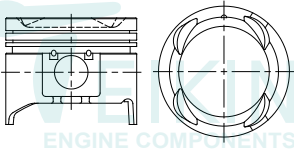
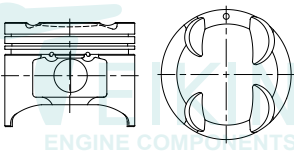
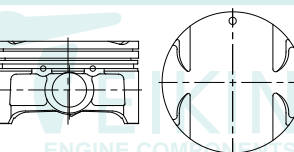
| ENGINE TYPE | PISTON | PISTON RING | PISTON PIN | PIN BUSHING | LINER | | LINER KIT SET |
|---|---|--------------------|--------------------------------|-------------|---------|-----------|---------------|
| | | | | | FLANGED | NO FLANGE | |
| B6-II 1597 cc 4 cyl. B5 | \emptyset 78.00 -3.10 CD 32.5 TL 63.0 | 2 - 1.5 1 - 3.0 | \emptyset 19.980 TL 65.00 | | | | TEIKIN NO. |
|  | TEIKIN NO. | | TEIKIN NO. | | | | |
| REFERENCE NO. B6Y2-11-SBX | 42172 | | P 42146 | | | | |
| Surface Treatment Bore Clearance None MRC: 0.030 mm MP: 16.50 mm | | | | | | | |
| B6-T 1597 cc 4 cyl. | \emptyset 78.00 -5.7 CD 32.3 TL 63.6 | 2 - 1.5 1 - 4.0 | \emptyset 19.990 TL 61.50 | | | | TEIKIN NO. |
|  | TEIKIN NO. | | TEIKIN NO. | | | | |
| REFERENCE NO. B6Z0-11-SA0 B6Z0-11-SA0C | 42662 | | P 42662 | | | | |
| Surface Treatment Bore Clearance None MRC: 0.030 mm MP: 14.30 mm | | | | | | | |
| B6ZE 1498 cc 4 cyl. B6-ME MX3 1994 - 95 F.I. DOHC 16V | \emptyset 78.00 -2.50 CD 31.9 TL 62.5 | 2 - 1.5 1 - 3.0 | \emptyset 19.990 TL 57.00 | | | | TEIKIN NO. |
|  | TEIKIN NO. | | TEIKIN NO. | | | | |
| REFERENCE NO. B6Z7-11-SAO 0K2YA-11-SAO B6BF-11-102 BP05-11-102 | 42668 | | P 44328 | | | | |
| Surface Treatment Bore Clearance None MRC: 0.030 mm MP: 15.50 mm | | | | | | | |
| MZR 1.5 L 1475 cc 4 cyl. MAZDA2 2011 | \emptyset 78.00 -1.7 CD 26.9 TL 45.5 | 2 - 1.2 1 - 2.5 | \emptyset 18.980 TL 58.00 | | | | TEIKIN NO. |
|  | TEIKIN NO. | | TEIKIN NO. | | | | |
| REFERENCE NO. ZYY3-11-SA0 | 42219 | | P 42202 | | | | |
| Surface Treatment Bore Clearance Moly Skirt MRC: 0.030 mm MP: 7.00 mm | | | | | | | |

| ENGINE TYPE | PISTON | PISTON RING | PISTON PIN | PIN BUSHING | LINER | | LINER KIT SET |
|---|--|-------------------------------|---|-------------|---------|-----------|---------------|
| | | | | | FLANGED | NO FLANGE | |
| Z6 MAZDA3 1.6L 1600 cc 4 cyl. | \emptyset 78.00 -1.9 CD 29.8 TL 48.3 | 2 - 1.2 1 - 2.5 | \emptyset 18.980 TL 58.00 | | | | TEIKIN NO. |
| | TEIKIN NO. 42211 | | TEIKIN NO. P 42202 | | | | |
| Surface Treatment None | Bore Clearance MRC: 0.030 mm MP: 5.00 mm | | REFERENCE NO. Z6Y1-11-SAO | | | | 25 |
| ZL-VE 1498 cc 4 cyl. | \emptyset 78.00 -1.6 CD 30.6 TL 54.0 | 1 - 1.2 1 - 1.5 1 - 3.0 | \emptyset 20.000 TL 61.00 | | | | TEIKIN NO. |
| | TEIKIN NO. 42672 | | TEIKIN NO. P 46310 | | | | |
| Surface Treatment Tin Coated | Bore Clearance MRC: 0.030 mm MP: 11.00 mm | | REFERENCE NO. ZLY2-11-SAO ZLY2-11-SBO ZLY2-11-SBX | | | | 26 |
| ZM PROTEGE 1999-2002 F.I. DOHC 16V 1590 cc 4 cyl. | \emptyset 78.00 -3.8 CD 31.0 TL 54.5 | 1 - 1.2 1 - 1.5 1 - 3.0 | \emptyset 19.980 TL 61.00 | | | | TEIKIN NO. |
| | TEIKIN NO. 42214 | | TEIKIN NO. P 42173 | | | | |
| Surface Treatment None | Bore Clearance MRC: 0.030 mm MP: 11.00 mm | | REFERENCE NO. ZMY0-11-SAO | | | | 27 |
| KF 1995 cc 6 cyl. | \emptyset 78.00 +1.5 CD 28.7 TL 57.5 | 2 - 1.5 1 - 3.0 | \emptyset 18.980 TL 59.00 | | | | TEIKIN NO. |
| | TEIKIN NO. 42665 | | TEIKIN NO. P 42665 | | | | |
| Surface Treatment Tin Coated Moly Skirt | Bore Clearance MRC: 0.030 mm MP: 7.00 mm | | REFERENCE NO. KFY1-11-SAO (R/L) | | | | 28 |

M

| ENGINE TYPE | PISTON | PISTON RING | PISTON PIN | PIN BUSHING | LINER | | LINER KIT SET |
|--|--|-------------------------------|--------------------------------|-------------|---------|-----------|---------------|
| | | | | | FLANGED | NO FLANGE | |
| F6 1982 1587 cc 4 cyl. | \emptyset 81.00 +4.7 CD 34.3 TL 76.0 | 2 - 1.5 1 - 4.0 | \emptyset 21.980 TL 67.00 | | | | TEIKIN NO. |
| | TEIKIN NO. 42159 | | TEIKIN NO. P 42164 | | | | |
| Surface Treatment None | Bore Clearance MRC: 0.030 mm MP: 20.00 mm | | | | | | |
| | REFERENCE NO. F605-23-200 | | | | | | 33 |
| GY MPV 2000-01 DOHC 24V 2498 cc 6 cyl. | \emptyset 81.65 +2.0 CD 30.0 TL 55.6 | 1 - 1.2 1 - 1.5 1 - 3.0 | \emptyset 21.015 TL 55.50 | | | | TEIKIN NO. |
| | TEIKIN NO. 42199 | | TEIKIN NO. P 42199 | | | | |
| Surface Treatment Moly Skirt | Bore Clearance MRC: 0.030 mm MP: 9.50 mm | | | | | | |
| | REFERENCE NO. GY01-11-100C 1U2ZZ6100AA | | | | | | 34 |
| VA 1985 cc 4 cyl. | \emptyset 82.00 CD 45.0 TL 83.5 | 2 - 2.0 1 - 4.5 | \emptyset 22.000 TL 71.00 | | | | TEIKIN NO. |
| | TEIKIN NO. 42612 (42181) | | TEIKIN NO. P 42612 | | | | |
| Surface Treatment Tin Coated | Bore Clearance MRC: 0.030 mm MP: 24.00 mm | | | | | | |
| | REFERENCE NO. 0553-23-200 | | | | | | 35 |
| BP 1839 cc 4 cyl. | \emptyset 83.00 -2.5 CD 30.7 TL 61.0 | 2 - 1.5 1 - 3.0 | \emptyset 19.985 TL 61.00 | | | | TEIKIN NO. |
| | TEIKIN NO. 42661 | | TEIKIN NO. P 42661 | | | | |
| Surface Treatment Tin Coated | Bore Clearance MRC: 0.030 mm MP: 10.00 mm | | | | | | |
| | REFERENCE NO. BPY0-11-SA0 BPY0-11-SA0A | | | | | | 36 |

M

| ENGINE TYPE | PISTON | PISTON RING | PISTON PIN | PIN BUSHING | LINER | | LINER KIT SET |
|---|--|-------------------------------|------------------------------------|-------------|---------|-----------|---------------|
| | | | | | FLANGED | NO FLANGE | |
| BP05 1839 cc 1990-96 F.I., DOHC PROTEGE, MIATA 4 cyl. | \emptyset 83.00 +0.5 CD 30.7 TL 61.5 | 2 - 1.5 1 - 3.0 | \emptyset 20.000 TL 56.58 | | | | TEIKIN NO. |
| | TEIKIN NO. | | TEIKIN NO. | | | | |
| Surface Treatment Bore Clearance Tin Coated MRC: 0.020 mm MP: 15.00 mm | REFERENCE NO. BPY1-11-SAO BPY1-11-SAOA | | | | | | 37 |
| BP-II 1839 cc MIATA 1999-2002 DOHC 16V 4 cyl. | \emptyset 83.00 +2.0 CD 30.7 TL 63.0 | 2 - 1.5 1 - 3.0 | \emptyset 20.000 TL 56.58 | | | | TEIKIN NO. |
| | TEIKIN NO. | | TEIKIN NO. | | | | |
| Surface Treatment Bore Clearance None MRC: 0.020 mm MP: 15.00 mm | REFERENCE NO. BPZ0-11-SAO | | | | | | 38 |
| BP-III 1839 cc MIATA 2001-2005 4 cyl. | \emptyset 83.00 +3.0 CD 30.7 TL 64.0 | 2 - 1.5 1 - 3.0 | \emptyset 20.000 TL 56.58 | | | | TEIKIN NO. |
| | TEIKIN NO. | | TEIKIN NO. | | | | |
| Surface Treatment Bore Clearance None MRC: 0.030 mm MP: 15.00 mm | REFERENCE NO. BPZ3-11-SAO | | | | | | 39 |
| FP 1839 cc PROTEGE 1999-2000 F.I. DOHC 16V 4 cyl. | \emptyset 83.00 -6.3 CD 29.8 TL 53.8 | 1 - 1.2 1 - 1.5 1 - 3.0 | \emptyset 18.980 TL 58.00 | | | | TEIKIN NO. |
| | TEIKIN NO. | | TEIKIN NO. | | | | |
| Surface Treatment Bore Clearance None MRC: 0.030 mm MP: 11.00 mm | REFERENCE NO. FPY1-11-SAO | | | | | | 40 |





SUITABLE FOR

MAZDA



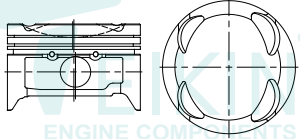
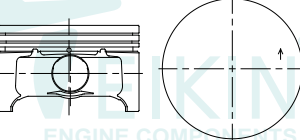
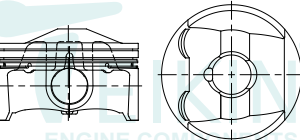

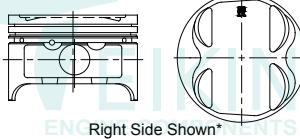
GASOLINE

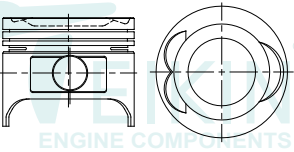
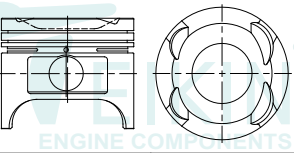
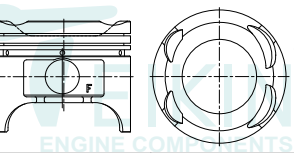
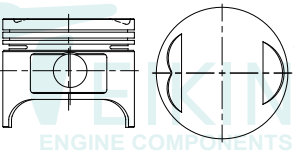

| ENGINE TYPE | PISTON | PISTON RING | PISTON PIN | PIN BUSHING | LINER | | LINER KIT SET |
|--|--|-------------------------------|---|-------------|---------|-----------|---------------|
| | | | | | FLANGED | NO FLANGE | |
| FS 1991 cc 4 cyl. FP 626, MX6 16 VALVE, F.1., DOHC 4 1993-1995  | \emptyset 83.00 -8.5 CD 29.9 TL 53.9 | 1 - 1.2 1 - 1.5 1 - 3.0 | \emptyset 19.000 TL 58.00 | | | | TEIKIN NO. |
| Surface Treatment Bore Clearance Tin Coated MRC: 0.020 mm MP: 11.00 mm | TEIKIN NO. 42166 (42650) | | TEIKIN NO. P 32125 | | | | 41 |
| | REFERENCE NO. FSY1-11-SA0 FP01-11-102A | | | | | | |
| L8 1798 cc 4 cyl.  | \emptyset 83.00 CD 28.5 TL 51.0 | 2 - 1.2 1 - 2.5 | \emptyset 21.000 TL 60.00 | | | | TEIKIN NO. |
| Surface Treatment Bore Clearance Moly Skirt MRC: 0.030 mm 1st Ring Anodized MP: 10.50 mm | TEIKIN NO. 42676 | | TEIKIN NO. P 42676 | | | | 42 |
| | REFERENCE NO. L8Y1-11-010 L8Y1-11-SA0 L8Y1-11-SAOA | | | | | | |
| SKYACTIV-G 1998 cc 4 cyl. MAZDA CX-5  | \emptyset 83.50 +8.3 CD 25.7 TL 54.6 | 2 - 1.0 1 - 2.0 | \emptyset 21.000 TL 45.00  | | | | TEIKIN NO. |
| Surface Treatment Bore Clearance Moly Skirt MRC: 0.030 mm Anodized Crown MP: 7.60 mm 1st Ring Anodized | TEIKIN NO. 42220 | | TEIKIN NO. P 42220 | | | | 43 |
| | REFERENCE NO. PEY2-11-SAOA | | | | | | |
| KL 2496 cc 6 cyl.  | \emptyset 84.50 -1.7 CD 29.2 TL 56.0 | 2 - 1.5 1 - 3.0 | \emptyset 19.990 TL 61.50 | | | | TEIKIN NO. |
| Surface Treatment Bore Clearance Tin Coated MRC: 0.030 mm Moly Skirt MP: 13.00 mm | TEIKIN NO. 42664 | | TEIKIN NO. P 42662 | | | | 44 |
| Right Side Shown* REFERENCE NO. KLY1-11-SA0 (L) KLY1-11-SL0 (R) | | | | | | | |

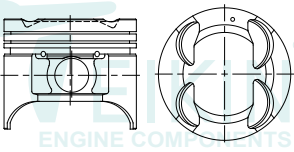
| ENGINE TYPE | PISTON | PISTON RING | PISTON PIN | PIN BUSHING | LINER | | LINER KIT SET |
|--|---|--------------------|--------------------------------|-------------|---------|-----------|---------------|
| | | | | | FLANGED | NO FLANGE | |
| F2 2184 cc 626 4 cyl. 1987-93 F.I., /CARB., SOHC PICKUP | \emptyset 86.00 -5.4 CD 36.1 TL 70.9 | 2 - 1.5 1 - 4.0 | \emptyset 21.980 TL 67.00 | | | | TEIKIN NO. |
|  | TEIKIN NO. 42164 | | TEIKIN NO. P 42164 | | | | |
| Surface Treatment Tin Coated Bore Clearance MRC: 0.030 mm MP: 19.90 mm | REFERENCE NO. F2Y4-11-SAO | | | | | | 45 |
| F2-II 2200 cc N 2200 4 cyl. 626, 1988-92 F.I., SOHC, 16V | \emptyset 86.00 -6.80 CD 36.5 TL 71.5 | 2 - 1.5 1 - 4.0 | \emptyset 21.980 TL 67.00 | | | | TEIKIN NO. |
|  | TEIKIN NO. 42192 | | TEIKIN NO. P 42164 | | | | |
| Surface Treatment Tin Coated Bore Clearance MRC: 0.030 mm MP: 19.90 mm | REFERENCE NO. F2Y2-11-SAO | | | | | | 46 |
| F2T 2184 cc 626 - MX-6 4 cyl. SOHC 16V | \emptyset 86.00 -9.5 CD 36.5 TL 71.5 | 2 - 1.5 1 - 4.0 | \emptyset 22.000 TL 67.00 | | | | TEIKIN NO. |
|  | TEIKIN NO. 42678 | | TEIKIN NO. P 44703 | | | | |
| Surface Treatment None Bore Clearance MRC: 0.030 mm MP: 19.90 mm | REFERENCE NO. F220-11-SAO | | | | | | 47 |
| F8 1789 cc 1982 4 cyl. | \emptyset 86.00 -3.7 CD 34.0 TL 71.0 | 2 - 1.5 1 - 4.0 | \emptyset 21.980 TL 67.00 | | | | TEIKIN NO. |
|  | TEIKIN NO. 42168 | | TEIKIN NO. P 42164 | | | | |
| Surface Treatment None Bore Clearance MRC: 0.050 mm MP: 20.20 mm | REFERENCE NO. F801-23-200 F801-11-102 | | | | | | 48 |

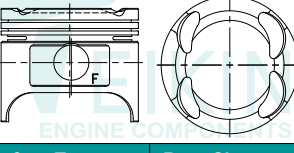
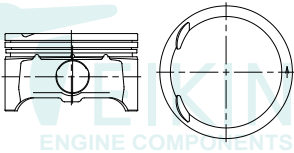
M

| ENGINE TYPE | PISTON | PISTON RING | PISTON PIN | PIN BUSHING | LINER | | LINER KIT SET |
|--|--|--------------------|---|-------------|---------|-----------|---------------|
| | | | | | FLANGED | NO FLANGE | |
| FE-VII 1998 cc 4 cyl.  | \emptyset 86.00 -1.6 CD 36.5 TL 71.4 | 2 - 1.5 1 - 4.0 | \emptyset 22.000 TL 72.00  | | | | TEIKIN NO. |
| Surface Treatment None Bore Clearance MRC: 0.030 mm MP: 20.00 mm | TEIKIN NO. 42206 | | TEIKIN NO. P 46199 | | | | 53 |
| | REFERENCE NO. FEYA-11-SAOC | | | | | | |
| FE-VIII 2300 cc 4 cyl.  | \emptyset 86.00 -2.3 CD 34.0 TL 70.5 | 2 - 1.5 1 - 4.0 | \emptyset 21.980 TL 67.00 | | | | TEIKIN NO. |
| Surface Treatment None Bore Clearance MRC: 0.050 mm MP: 20.00 mm | TEIKIN NO. 42218 | | TEIKIN NO. P 42164 | | | | 54 |
| | REFERENCE NO. FEJK-11-SA0A | | | | | | |
| L3 2300 cc MAZDA3 2001-2006 4 cyl.  | \emptyset 87.50 -4.0 CD 28.5 TL 51.0 | 2 - 1.2 1 - 2.5 | \emptyset 21.000 TL 61.50 | | | | TEIKIN NO. |
| Surface Treatment Anodized Crown Moly Skirt Bore Clearance MRC: 0.030 mm MP: 10.00 mm | TEIKIN NO. 42205 | | TEIKIN NO. P 56104 | | | | 55 |
| | REFERENCE NO. L3Y5-11-010 L3Y9-11-010 | | | | | | |
| L3-II 2300 cc MAZDA6 2.3L 4 cyl.  | \emptyset 87.50 -3.3 CD 28.5 TL 51.0 | 2 - 1.2 1 - 2.5 | \emptyset 21.000 TL 61.50 | | | | TEIKIN NO. |
| Surface Treatment Moly Skirt Anodized Crown 1st Ring Anodized Bore Clearance MRC: 0.030 mm MP: 10.00 mm | TEIKIN NO. 42209 | | TEIKIN NO. P 56104 | | | | 56 |
| | REFERENCE NO. L3Y7-11-010 L3Y2-11-010 L3Y2-11SAO L3Y2-11-SAOA | | | | | | |



M



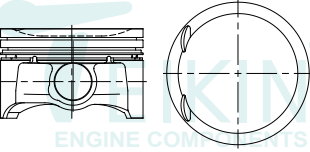
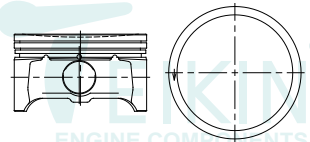
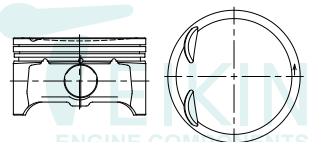

SUITABLE FOR

MAZDA

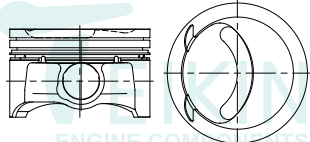

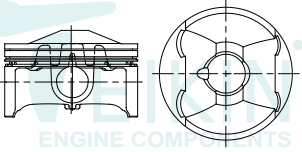

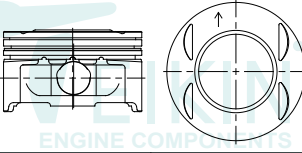

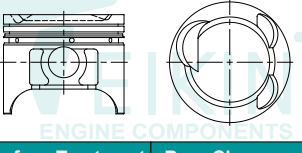
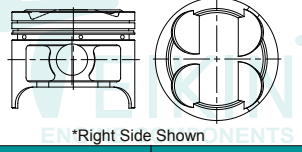

GASOLINE

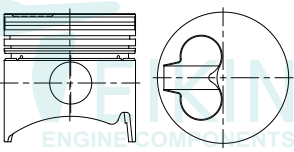

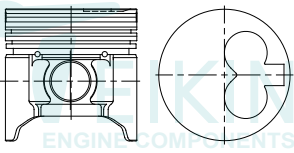

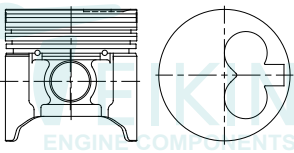

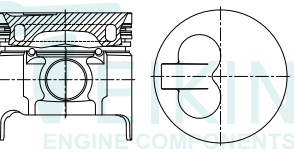



| ENGINE TYPE | PISTON | PISTON RING | PISTON PIN | PIN BUSHING | LINER | | LINER KIT SET |
|--|---|--------------------|---|-------------|---------|-----------|---------------|
| | | | | | FLANGED | NO FLANGE | |
| L3-III 2261 cc MAZDA CX-7 2006 MAZDA3 4 cyl. | \emptyset 87.50 -4.5 CD 32.5 TL 55.0 | 2 - 1.5 1 - 2.0 | \emptyset 22.500 TL 65.00  | | | | TEIKIN NO. |
|  | TEIKIN NO. | | TEIKIN NO. | | | | |
| | 42222 | | P 42221 | | | | |
| Surface Treatment Bore Clearance Moly Skirt Anodized Crown 1st Ring Anodized MRC: 0.030 mm MP: 11.50 mm | REFERENCE NO. L3Y0-11-SA0 | | | | | | 57 |
| LF 2000 cc MAZDA3 2.0 MAZDA6 2.0 4 cyl. | \emptyset 87.50 -2.0 CD 28.5 TL 51.0 | 2 - 1.2 1 - 2.5 | \emptyset 21.000 TL 61.50 | | | | TEIKIN NO. |
|  | TEIKIN NO. | | TEIKIN NO. | | | | |
| | 42210 | | P 56104 | | | | |
| Surface Treatment Bore Clearance Moly Skirt Anodized Crown 1st Ring Anodized MRC: 0.030 mm MP: 10.00 mm | REFERENCE NO. LFY2-11-010 | | | | | | 58 |
| LF-II 4 cyl. | \emptyset 87.50 -2.0 CD 28.5 TL 51.0 | 2 - 1.2 1 - 2.5 | \emptyset 21.000 TL 61.50 | | | | TEIKIN NO. |
|  | TEIKIN NO. | | TEIKIN NO. | | | | |
| | 42216 | | P 56104 | | | | |
| Surface Treatment Bore Clearance Moly Skirt Anodized Crown 1st Ring Anodized MRC: 0.030 mm MP: 10.00 mm | REFERENCE NO. LFY5-11-010 | | | | | | 59 |
| MZR 2.3 L 2261 cc MAZDA CX-7 2009 4 cyl. | \emptyset 87.50 -5.5 CD 32.5 TL 55.0 | 2 - 1.5 1 - 2.0 | \emptyset 22.500 TL 65.00  | | | | TEIKIN NO. |
|  | TEIKIN NO. | | TEIKIN NO. | | | | |
| | 42221 | | P 42221 | | | | |
| Surface Treatment Bore Clearance Moly Skirt Anodized Crown 1st Ring Anodized MRC: 0.030 mm MP: 11.50 mm | REFERENCE NO. L3Y4-11-SA0 | | | | | | 60 |

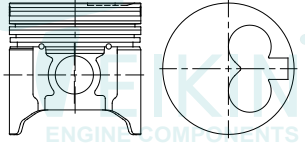

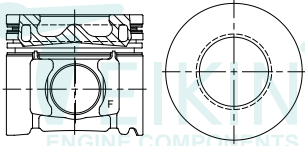

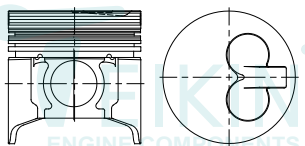



| ENGINE TYPE | PISTON | PISTON RING | PISTON PIN | PIN BUSHING | LINER | | LINER KIT SET |
|--|--|-------------------------------|---|-------------|---------|-----------|---------------|
| | | | | | FLANGED | NO FLANGE | |
| SKYACTIV-G 2.5L 2488 cc 4 cyl.  Surface Treatment Moly Skirt Anodized Crown 1st Ring Anodized Bore Clearance MRC: 0.030 mm MP: 9.70 mm | \emptyset 89.00 +8.8 CD 25.8 TL 58.0 | 2 - 1.0 1 - 2.0 | \emptyset 21.000 TL 49.50  | | | | TEIKIN NO. |
| | TEIKIN NO. 42223 | | TEIKIN NO. P 42223 | | | | |
| | REFERENCE NO. PYY1-11-SAO | | | | | | 61 |
| AJ 2967 cc 6 cyl. 3.0L DOHC 24V MPV 02-05 TRIBUTE 01-05  Surface Treatment Moly Skirt Bore Clearance MRC: 0.030 mm MP: 7.00 mm | \emptyset 89.00 +1.00 CD 30.0 TL 52.6 | 1 - 1.2 1 - 1.5 1 - 2.5 | \emptyset 21.012 TL 60.50  | | | | TEIKIN NO. |
| | TEIKIN NO. 42207 | | TEIKIN NO. P 42207 | | | | |
| | REFERENCE NO. AJ0311100A ZZTT11100 AJTM11100 | | | | | | 62 |
| JE 2954 cc 6 cyl.  Surface Treatment Tin Coated Moly Skirt Bore Clearance MRC: 0.030 mm MP: 10.00 mm | \emptyset 90.00 -3.6 CD 35.5 TL 74.0 | 2 - 1.5 1 - 4.0 | \emptyset 23.000 TL 77.00 | | | | TEIKIN NO. |
| | TEIKIN NO. 42655 | | TEIKIN NO. P 42655 | | | | |
| | REFERENCE NO. JEY6-11-SAO JEY6-11-SAOB | | | | | | 63 |
| JE-48 / JE-27 2954 cc 6 cyl. 929. 24 V 1992-96 F.I., DOHC V6  Surface Treatment Tin Coated Moly Skirt Bore Clearance MRC: 0.020 mm MP: 17.30 mm | \emptyset 90.00 +1.3 CD 35.1 TL 72.0 | 2 - 1.5 1 - 4.0 | \emptyset 22.980 TL 63.00 | | | | TEIKIN NO. |
| | TEIKIN NO. 42169 | | TEIKIN NO. P 42163 | | | | |
| | REFERENCE NO. JE27-11-SAO JEY8-11-SAO JEY9-11-SLO | | | | | | 64 |

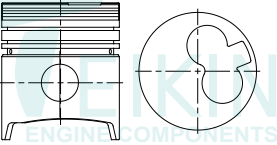

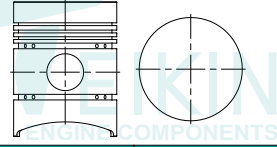

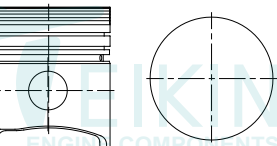

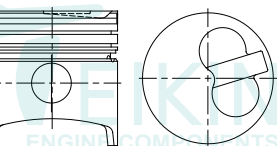

M

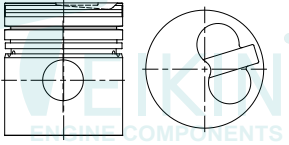
| ENGINE TYPE | PISTON | PISTON RING | PISTON PIN | PIN BUSHING | LINER | | LINER KIT SET | | |
|---|--|-------------------------------|---|------------------------------|--|--|---|---|-----------|
| | | | | | FLANGED | NO FLANGE | | | |
| PN 1720 cc 4 cyl.  | \varnothing 78.00 -2.6 CD 41.3 TL 76.1 | 1 - 2.0 1 - 1.5 1 - 3.0 | \varnothing 25.000 TL 64.00  | | TL 157.0 OD 82.0 FT 2.0 FD 86.0 | 155.0 82.0 | TEIKIN NO. LKSF 42601 LKSX 42601 | | |
| Surface Treatment Tin Coated Bore Clearance MRC: 0.030 mm MP: 15.00 mm | TEIKIN NO. 42601 (42175) | TEIKIN NO. R 42601 | TEIKIN NO. P 42601 | TEIKIN NO. B 42601 | TEIKIN NO. LSF 42601 LSX 42601 | REFERENCE NO. PN20-11-SBX PN20-11-SAO PN11-11-SAOB | REFERENCE NO. PN11-11-SCO PNY2-11-SCO PNY2-11-SCOA | REFERENCE NO. PN11-11-213 PN11-11-311 | 66 |
| R2 2184 cc 4 cyl. KIA BESTA 2.2L NB1, B2200  | \varnothing 86.00 -1.5 CD 47.3 TL 86.4 | 2 - 2.0 1 - 4.0 | \varnothing 25.000 TL 68.00  | | TL 165.0 OD 89.0 FT 4.0 FD 94.0 | 165.0 90.0 | TEIKIN NO. LKFF 42167 LKSF 42167 LKSX 42167 LKFF 42167A LKSF 42167A LKSX 42167A | | |
| Surface Treatment Tin Coated Bore Clearance MRC: 0.030 mm MP: 20.00 mm | TEIKIN NO. 42167 42167A | TEIKIN NO. R 42167 | TEIKIN NO. P 42167 | TEIKIN NO. B 42167 | TEIKIN NO. LFF 42167 LSF 42167 LSX 42167 | REFERENCE NO. RF01-23-200 K7YO-11-SAO RF01-23-200B | REFERENCE NO. R201-23-130A R201-23-130B | REFERENCE NO. RF01-11-213 R201-23-051 RF01-10-311 | 67 |
| R2 LATE 2184 cc 4 cyl.  | \varnothing 86.00 -1.7 CD 47.1 TL 86.1 | 2 - 2.0 1 - 3.0 | \varnothing 25.000 TL 68.00  | | TL 163.0 OD 89.0 FT 2.8 FD 94.0 | 163.0 90.0 | TEIKIN NO. LKFF 42611 LKSF 42611 LKSX 42611 LKFF 42611AG LKSF 42611AG LKSX 42611AG | | |
| Surface Treatment Tin Coated Bore Clearance MRC: 0.030 mm MP: 20.50 mm | TEIKIN NO. 42611 42611AG (42177) | TEIKIN NO. R 42611 | TEIKIN NO. P 42167 | TEIKIN NO. B 42167 | TEIKIN NO. LFF 42610 LSF 42610 LSX 42610 | REFERENCE NO. R2Y0-11-SAO | REFERENCE NO. R2B6-11-SCO RF2A-11-SCO RFY5-11-SCOA/DOA RFY5-11-SXOA | REFERENCE NO. RF01-11-213 R2B6-10-311 R2B6-10-313 | 68 |
| R2 NEW 2184 cc 4 cyl.  | \varnothing 86.00 -2.2 CD 43.2 TL 82.2 | 2 - 2.0 1 - 3.0 | \varnothing 25.000 TL 64.00  | | TL 163.0 OD 89.0 FT 2.8 FD 94.0 | 163.0 90.0 | TEIKIN NO. LKFF 42674AG LKSF 42674AG LKSX 42674AG | | |
| Surface Treatment Tin Coated Bore Clearance MRC: 0.040 mm MP: 21.40 mm | TEIKIN NO. 42674AG | TEIKIN NO. R 42611 | TEIKIN NO. P 42674 | TEIKIN NO. B 42167 | TEIKIN NO. LFF 42610 LSF 42610 LSX 42610 | REFERENCE NO. R2Y3-11-SAOB | REFERENCE NO. R2B6-11-SCO RF2A-11-SCO FY5-11-SCOA/DOA RFY5-11-SXOA | REFERENCE NO. RF01-11-213 R2B6-10-311 R2B6-10-313 | 69 |

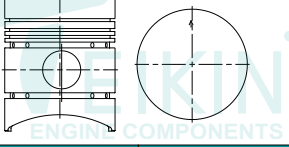

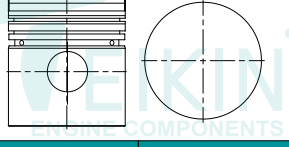
| ENGINE TYPE | PISTON | PISTON RING | PISTON PIN | PIN BUSHING | LINER | | LINER KIT SET |
|---|--|---|---|--|--|---------------|---|
| | | | | | FLANGED | NO FLANGE | |
| RF 1998 cc 4 cyl.  | \emptyset 86.00 -3.4 CD 47.2 TL 86.2 | 1 - 2.0 HK 1 - 2.0 1 - 3.0 | \emptyset 30.000 TL 68.00  | | TL 163.0 OD 89.0 FT 2.8 FD 94.0 | 163.0 90.0 | TEIKIN NO. LKFF 42610AG LKSF 42610AG LKXS 42610AG TEIKIN NO. LFF 42610 LSF 42610 LSX 42610 REFERENCE NO. R2B6-10-311 R2B6-10-313 |
| | TEIKIN NO. 42610AG (42176) | TEIKIN NO. R 42610 | TEIKIN NO. P 42610 | TEIKIN NO. B 42610 | TEIKIN NO. LFF 42610 LSF 42610 LSX 42610 | | |
| | REFERENCE NO. RFY4-11-SA0A RFY2-11-SCO | REFERENCE NO. RFY2-11-SCO RFY0-11-SCO | REFERENCE NO. RF5C-11-123 RF71-11-213 RF71-11-213A | REFERENCE NO. R2B6-10-311 R2B6-10-313 | | | |
| | Surface Treatment Bore Clearance Tin Coated MRC: 0.040 mm MP: 15.00 mm | | | | | | |
| 70 | | | | | | | |
| RF7 1998 cc 4 cyl. 16V 2002  | \emptyset 86.00 -13.7 CD 46.8 TL 75.8 | 2 - 2.0 1 - 3.0 | \emptyset 30.000 TL 68.00  | | TL 163.0 OD 89.0 FT 2.8 FD 94.0 | 163.0 90.0 | TEIKIN NO. LKFF 42675AG LKSF 42675AG LKXS 42675AG TEIKIN NO. LFF 42610 LSF 42610 LSX 42610 REFERENCE NO. R2B6-10-311 R2B6-10-313 |
| | TEIKIN NO. 42675AG | TEIKIN NO. R 42611 | TEIKIN NO. P 42675 | TEIKIN NO. B 42610 | TEIKIN NO. LFF 42610 LSF 42610 LSX 42610 | | |
| | REFERENCE NO. RFY7-11-SAOA/B REY7-11-SBOA RFY7-11-SBOB RFY7-11-SBXA/B | REFERENCE NO. R2B6-11-SCO RF2A-11-SCO RFY5-11-SCO/DOA RFY5-11-SXOA | REFERENCE NO. RF5C-11-123 RF71-11-213 RF71-11-213A | REFERENCE NO. R2B6-10-311 R2B6-10-313 | | | |
| | Surface Treatment Bore Clearance Moly Skirt MRC: 0.040 mm MP: 7.50 mm | | | | | | |
| 71 | | | | | | | |
| RF-II 1998 cc 4 cyl.  | \emptyset 86.00 -1.15 CD 47.3 TL 86.3 | 2 - 2.0 1 - 4.0 | \emptyset 30.000 TL 68.00  | | TL 165.0 OD 89.0 FT 4.0 FD 94.0 | 165.0 90.0 | TEIKIN NO. LKFF 42167A LKSF 42167A LKXS 42167A TEIKIN NO. LFF 42167 LSF 42167 LSX 42167 REFERENCE NO. R201-23-051 RF01-10-311 |
| | TEIKIN NO. 42671A | TEIKIN NO. R 42167 | TEIKIN NO. P 42671 | TEIKIN NO. B 42610 | TEIKIN NO. LFF 42167 LSF 42167 LSX 42167 | | |
| | REFERENCE NO. RFY0-11-SA0 RFY0-11-SA0A | REFERENCE NO. R201-23-130A R201-23-130B | REFERENCE NO. RF5C-11-123 RF71-11-213 RF71-11-213A | REFERENCE NO. R201-23-051 RF01-10-311 | | | |
| | Surface Treatment Bore Clearance Tin Coated MRC: 0.050 mm MP: 15.00 mm | | | | | | |
| 72 | | | | | | | |
| S2 2209 cc 4 cyl.  | \emptyset 88.90 -1.7 CD 50.7 TL 94.7 | 2 - 2.4 1 - 4.75 | \emptyset 28.000 TL 73.50  | | TL 167.5 OD 96.9 FT 3.8 +1.0 FD 101.0 | | TEIKIN NO. LKFF 42174 LKSF 42174 LKFF 42174A LKSF 42174A TEIKIN NO. LFF 42174 LSF 42174 REFERENCE NO. 1456-23-051 |
| | TEIKIN NO. 42174 42174A (42604) | TEIKIN NO. R 42174 | TEIKIN NO. P 42174 | TEIKIN NO. B 42174 | TEIKIN NO. LFF 42174 LSF 42174 | | |
| | REFERENCE NO. 1456-23-200A 1456-23-200 8259-23-200C | REFERENCE NO. 1456-23-206 | REFERENCE NO. 0911-11-213 1456-11-213 S213-11-213 | REFERENCE NO. 1456-23-051 | | | |
| | Surface Treatment Bore Clearance Tin Coated MRC: 0.040 mm MP: 25.00 mm | | | | | | |
| 73 | | | | | | | |

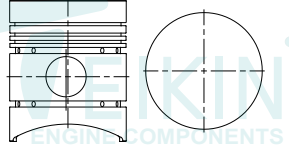
| ENGINE TYPE | PISTON | PISTON RING | PISTON PIN | PIN BUSHING | LINER | | LINER KIT SET |
|--|--|--|---|--|--|-----------|---|
| | | | | | FLANGED | NO FLANGE | |
| S5 2522 cc 4 cyl.  Surface Treatment Tin Coated Bore Clearance MRC: 0.030 mm MP: 23.50 mm | \varnothing 88.90 -1.9 CD 60.4 TL 103.4 | 2 - 2.4 1 - 4.75 | \varnothing 28.000 TL 73.50  | | TL 191.0 OD 96.9 FT 3.8 +0.8 FD 101.0 | | TEIKIN NO. LKFF 42606 LKSF 42606 |
| | TEIKIN NO. 42606 (42180) | TEIKIN NO. R 42174 | TEIKIN NO. P 42174 | TEIKIN NO. B 42606 | TEIKIN NO. LFF 42605 LSF 42605 | | |
| | REFERENCE NO. S501-23-200 S501-99-111 | REFERENCE NO. 1456-23-206 | REFERENCE NO. S501-11-213 | REFERENCE NO. 0636-10-311 S501-23-051 | | | |
| | | | | | | | |
| XA 2522 cc 4 cyl.  Surface Treatment Tin Coated Bore Clearance MRC: 0.040 mm MP: 23.00 mm | \varnothing 88.90 CD 60.6 TL 116.0 | 3 - 2.4 2 - 4.8 | \varnothing 31.750 TL 75.00  | | TL 191.0 OD 96.9 FT 3.8 +0.8 FD 101.0 | | TEIKIN NO. LKFF 42605 LKSF 42605 |
| | TEIKIN NO. 42605 (42178) | TEIKIN NO. R 42605 | TEIKIN NO. P 42149 | TEIKIN NO. B 42149 | TEIKIN NO. LFF 42605 LSF 42605 | | |
| | REFERENCE NO. 0559-99-111 0559-23-200 0636-23-200 0750-23-200 | REFERENCE NO. 0559-23-206/7 0636-23-206/7 0636-23-210 | REFERENCE NO. 0636-11-213 | REFERENCE NO. 0636-10-311 S501-23-051 | | | |
| | | | | | | | |
| XA-II 4 cyl.  Surface Treatment Tin Coated Bore Clearance MRC: 0.040 mm MP: 23.00 mm | \varnothing 88.90 CD 60.3 TL 103.3 | 2 - 2.4 1 - 4.75 | \varnothing 28.000 TL 73.50  | | TL 191.0 OD 96.9 FT 3.8 +0.8 FD 101.0 | | TEIKIN NO. LKFF 42659 LKSF 42659 |
| | TEIKIN NO. 42659 | TEIKIN NO. R 42174 | TEIKIN NO. P 42174 | TEIKIN NO. B 42606 | TEIKIN NO. LFF 42605 LSF 42605 | | |
| | REFERENCE NO. 0911-99-111B | REFERENCE NO. 1456-23-206 | REFERENCE NO. S501-11-213 | REFERENCE NO. 0636-10-311 S501-23-051 | | | |
| | | | | | | | |
| SF K2400 2400 cc 4 cyl.  Surface Treatment Tin Coated Bore Clearance MRC: 0.030 mm MP: 24.75 mm | \varnothing 92.00 -4.6 CD 50.6 TL 94.6 | 2 - 2.4 1 - 4.0 | \varnothing 28.000 TL 74.80  | | TL 165.0 OD 96.9 FT 3.9 +0.8 FD 100.9 | | TEIKIN NO. LKFF 42658 LKSF 42658 LKFF 42658A LKSF 42658A |
| | TEIKIN NO. 42658 42658A | TEIKIN NO. R 42658 | TEIKIN NO. P 32127 | TEIKIN NO. B 42658 | TEIKIN NO. LFF 42658 LSF 42658 | | |
| | REFERENCE NO. K7Z0-11-SAO K768-11-102 | REFERENCE NO. K756-23-206 K7Z0-11-SCO 0K7Z0-11-SCO 0K7Z0-11-SCY/Z | REFERENCE NO. 1456-10-311/B K456-10-311 K756-10-311 K75A-10-311 | | | | |
| | | | | | | | |

| ENGINE TYPE | PISTON | PISTON RING | PISTON PIN | PIN BUSHING | LINER | | LINER KIT SET |
|--|--|-----------------------------------|---|-------------|--|-----------|---|
| | | | | | FLANGED | NO FLANGE | |
| SS K2700 2700 cc 4 cyl. CD 60.3 TL 103.3  | \emptyset 92.00 -5.1 MRC: 0.030 mm MP: 13.60 mm | 1 - 2.85 FK 1 - 2.4 1 - 4.0 | \emptyset 31.750 TL 75.00  | | TL 192.0 OD 96.9 FT 3.8 +0.7 FD 101.0 | | TEIKIN NO. LKFF 42198 LKSF 42198 LKFF 42198A LKSF 42198A TEIKIN NO. R 42198 P 42149 B 42198 LFF 42198 LSF 42198 REFERENCE NO. K4Z0-11-SAO K480-11-102 K4Z0-11-SCO K480-23-206 K800-10-311A |
| | TEIKIN NO. | TEIKIN NO. | TEIKIN NO. | TEIKIN NO. | TEIKIN NO. | | |
| | TEIKIN NO. | TEIKIN NO. | TEIKIN NO. | TEIKIN NO. | TEIKIN NO. | | |
| | TEIKIN NO. | TEIKIN NO. | TEIKIN NO. | TEIKIN NO. | TEIKIN NO. | | |
| Surface Treatment Bore Clearance Tin Coated MRC: 0.030 mm MP: 13.60 mm | | | | | | | 78 |
| XB 2700 cc 4 cyl. E-2700 1969-80 CD 60.3 TL 115.8  | \emptyset 92.00 MRC: 0.070 mm MP: 31.25 mm | 3 - 2.4 2 - 4.8 | \emptyset 31.750 TL 75.00  | | TL 191.0 OD 96.9 FT 3.8 +0.8 FD 101.0 | | TEIKIN NO. LKFF 42150 LKSF 42150 TEIKIN NO. R 42150 P 42149 B 42149 LFF 42150 LSF 42150 REFERENCE NO. 0528-23-200 0527-23-206 0528-23-206 0636-11-213 0528-10-311 0527-23-051 0552-10-311 |
| | TEIKIN NO. | TEIKIN NO. | TEIKIN NO. | TEIKIN NO. | TEIKIN NO. | | |
| | TEIKIN NO. | TEIKIN NO. | TEIKIN NO. | TEIKIN NO. | TEIKIN NO. | | |
| | TEIKIN NO. | TEIKIN NO. | TEIKIN NO. | TEIKIN NO. | TEIKIN NO. | | |
| Surface Treatment Bore Clearance None MRC: 0.070 mm MP: 31.25 mm | | | | | | | 79 |
| ZB 4052 cc 6 cyl. T-4100 1980-ON CD 60.3 TL 103.3  | \emptyset 92.00 MRC: 0.030 mm MP: 13.60 mm | 2 - 2.4 1 - 4.8 | \emptyset 31.750 TL 75.00  | | TL 191.0 OD 96.9 FT 3.8 +0.8 FD 101.0 | | TEIKIN NO. LKFF 42179 LKSF 42179 LKFF 42179A LKSF 42179A TEIKIN NO. R 42179 P 42149 B 42179 LFF 42179 LSF 42179 REFERENCE NO. V101-23-200 V101-23-206 0636-11-213 0528-10-311 V101-23-051 |
| | TEIKIN NO. | TEIKIN NO. | TEIKIN NO. | TEIKIN NO. | TEIKIN NO. | | |
| | TEIKIN NO. | TEIKIN NO. | TEIKIN NO. | TEIKIN NO. | TEIKIN NO. | | |
| | TEIKIN NO. | TEIKIN NO. | TEIKIN NO. | TEIKIN NO. | TEIKIN NO. | | |
| Surface Treatment Bore Clearance Tin Coated MRC: 0.030 mm MP: 13.60 mm | | | | | | | 80 |
| ZB OLD 4050 cc 6 cyl. 1972-80 CD 60.3 TL 115.8  | \emptyset 92.00 MRC: 0.070 mm MP: 31.25 mm | 3 - 2.4 2 - 4.8 | \emptyset 31.750 TL 75.00  | | TL 191.0 OD 96.9 FT 3.8 +0.8 FD 101.0 | | TEIKIN NO. LKFF 42150-6 LKSF 42150-6 TEIKIN NO. R 42150-6 P 42149 B 42179 LFF 42179 LSF 42179 REFERENCE NO. 0528-23-200 0784-23-206 0785-23-206 0636-11-213 0528-10-311 V101-23-051 |
| | TEIKIN NO. | TEIKIN NO. | TEIKIN NO. | TEIKIN NO. | TEIKIN NO. | | |
| | TEIKIN NO. | TEIKIN NO. | TEIKIN NO. | TEIKIN NO. | TEIKIN NO. | | |
| | TEIKIN NO. | TEIKIN NO. | TEIKIN NO. | TEIKIN NO. | TEIKIN NO. | | |
| Surface Treatment Bore Clearance None MRC: 0.070 mm MP: 31.25 mm | | | | | | | 81 |

| ENGINE TYPE | PISTON | PISTON RING | PISTON PIN | PIN BUSHING | LINER | | LINER KIT SET |
|--|--|--|---|-------------------------------------|--|-----------|---|
| | | | | | FLANGED | NO FLANGE | |
| HA 2977 cc E-3000 1981 4 cyl. | \emptyset 95.00 CD 58.5 TL 115.5 | 2 - 2.4 1 - 4.8 | \emptyset 31.750 TL 75.00 | | TL 189.0 OD 98.5 FT 3.8 +0.8 FD 103.5 | | TEIKIN NO. LKFF 42149 LKSF 42149 LKFF 42149A LKSF 42149A |
| | TEIKIN NO. 42149 42149A | TEIKIN NO. R 42149 | TEIKIN NO. P 42149 | TEIKIN NO. B 42149 | TEIKIN NO. LFF 42149 LSF 42149 | | 86 |
| Surface Treatment Tin Coated | Bore Clearance MRC: 0.110 mm MP: 28.30 mm | REFERENCE NO. 0933-23-200 1363-23-200 | REFERENCE NO. 1363-23-206 SE01-23-130 SE01-23-206 | REFERENCE NO. 0636-11-213 | REFERENCE NO. 1363-23-051 1363-23-051A SE01-23-051 | | |
| HA-II 2977 cc 4 cyl. | \emptyset 95.00 -2.0 CD 53.7 TL 100.7 | 2 - 2.4 1 - 4.75 | \emptyset 30.000 TL 79.00 | | TL 189.0 OD 98.5 FT 3.8 +0.8 FD 103.5 | | |
| | TEIKIN NO. 42609 42609A (42189) | TEIKIN NO. R 42149 | TEIKIN NO. P 42609 | TEIKIN NO. B 42609 | TEIKIN NO. LFF 42149 LSF 42149 | | 87 |
| Surface Treatment Tin Coated | Bore Clearance MRC: 0.040 mm MP: 39.50 mm | REFERENCE NO. SE01-23-200A | REFERENCE NO. 1363-23-206 SE01-23-206 SE01-23-130 | REFERENCE NO. SE01-11-213 | REFERENCE NO. 1363-23-051 1362-23-051A SE01-23-051 | | |
| W9 2900 cc B2900 4 cyl. | \emptyset 95.00 -3.1 CD 47.8 TL 87.3 | 1 - 2.5 1 - 2.0 1 - 3.0 | \emptyset 32.000 TL 70.00 | | TL 189.0 OD 98.5 FT 3.8 +0.8 FD 103.5 | | |
| | TEIKIN NO. 42215AG | TEIKIN NO. R 42215 | TEIKIN NO. P 42185 | TEIKIN NO. B 42215 | TEIKIN NO. LFF 42149 LSF 42149 | | 88 |
| Surface Treatment Tin Coated | Bore Clearance MRC: 0.030 mm MP: 17.50 mm | REFERENCE NO. W9Y1-11-SA0B | REFERENCE NO. W9Y1-11-SCO | REFERENCE NO. | REFERENCE NO. 1363-23-051 1362-23-051A SE01-23-051 | | |
| MZR-CD 3000 cc BT-50 3000 cc 4 cyl. | \emptyset 96.00 -16.2 CD 51.7 TL 86.2 | 1 - 2.0 1 - 1.5 1 - 2.0 | \emptyset 34.000 TL 70.00 | | | | |
| | TEIKIN NO. 42213AG | TEIKIN NO. R 42213 | TEIKIN NO. P 42212 | TEIKIN NO. B 42213 | TEIKIN NO. LFF 42213 LSF 42213 | | 89 |
| Surface Treatment Moly Skirt | Bore Clearance MRC: 0.050 mm MP: 11.00 mm | REFERENCE NO. WEY1-11-SAO | REFERENCE NO. WEY1-11-SCO | REFERENCE NO. WE01-11-213 | REFERENCE NO. | | |

| ENGINE TYPE | PISTON | PISTON RING | PISTON PIN | PIN BUSHING | LINER | | LINER KIT SET |
|---|---|---|--------------------------------------|--|---|-----------|---|
| | | | | | FLANGED | NO FLANGE | |
| SL 3455 cc T-3500T KIA SH, K3600 4 cyl. | \varnothing 100.00 -21.3 CD 58.0 TL 105.0 | 1- 2.5 1- 2.0 1- 4.5 | \varnothing 34.000 TL 82.00 | | TL 193.5 OD 103.5 FT 2.5 +0.8 FD 108.0 | | TEIKIN NO. LKFF 42107 LKSF 42107 LKFF 42107G LKSF 42107G |
| | TEIKIN NO. 42107 42107G | TEIKIN NO. R 42107 | TEIKIN NO. P 42107 | TEIKIN NO. B 42107 | TEIKIN NO. LFF 42107 LSF 42107 | | 90 |
| Surface Treatment Bore Clearance Anodized Crown MRC: 0.050 mm MP: 20.40 mm | REFERENCE NO. SL07-23-200 SL07-23-200B | REFERENCE NO. SL07-23-206 SL07-23-206A | REFERENCE NO. SL01-11-213 | REFERENCE NO. SL01-23-311 SL01-23-312 SL07-23-051 | | | |
| SL-III 4 cyl. | \varnothing 100.00 -18.6 CD 57.8 TL 104.6 | 1- 2.5 HK 1- 2.0 1- 4.5 | \varnothing 34.000 TL 82.00 | | | | |
| | TEIKIN NO. 42201 42201A (42666) | | TEIKIN NO. P 42107 | | | | 91 |
| Surface Treatment Bore Clearance Tin Coated MRC: 0.070 mm MP: 21.00 mm | REFERENCE NO. | | | | | | |
| SL-T 3455 cc 4 cyl. | \varnothing 100.00 -18.6 CD 58.2 TL 105.2 | 1- 2.5 1- 2.0 1- 4.5 | \varnothing 34.000 TL 82.00 | | TL 193.5 OD 103.5 FT 2.5 +0.8 FD 108.0 | | |
| | TEIKIN NO. 42613AG (42190) | TEIKIN NO. R 42613 | TEIKIN NO. P 42107 | TEIKIN NO. B 42107 | TEIKIN NO. LFF 42107 LSF 42107 | | 92 |
| Surface Treatment Bore Clearance Tin Coated MRC: 0.060 mm MP: 23.50 mm | REFERENCE NO. SL50-11-SAO | REFERENCE NO. SL50-11-SCO | REFERENCE NO. SL01-11-213 | REFERENCE NO. SL01-23-311 SL01-23-312 SL07-23-051 | | | |
| TF 4021 cc 4 cyl. | \varnothing 105.50 -21.7 CD 61.3 TL 108.3 | 1- 2.5 HK 1- 2.0 1- 4.5 | \varnothing 35.000 TL 87.50 | | TL 200.0 OD 109.0 FT 6.0 +1.0 FD 114.5 | | |
| | TEIKIN NO. 42183 42183A | TEIKIN NO. R 42184 | TEIKIN NO. P 39149 | TEIKIN NO. B 42184 | TEIKIN NO. LFF 42183 LSF 42183 | | 93 |
| Surface Treatment Bore Clearance Tin Coated MRC: 0.050 mm MP: 20.00 mm | REFERENCE NO. TF01-11-SAO | REFERENCE NO. TF01-11-SCO | REFERENCE NO. TF01-11-213 | REFERENCE NO. TFY0-10-311 TFY0-10-311A TFY0-10-311B TFY0-10-313 | | | |



M

SUITABLE FOR

MAZDA

DIESEL

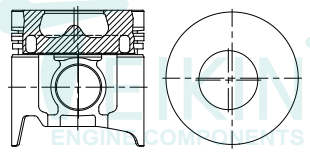

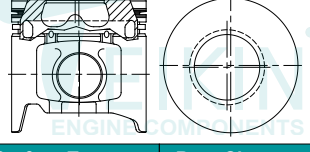

| ENGINE TYPE | PISTON | PISTON RING | PISTON PIN | PIN BUSHING | LINER | | LINER KIT SET |
|--|---|--|---|-------------------------------------|--|-----------|---|
| | | | | | FLANGED | NO FLANGE | |
| TF-II 4021 cc T-4000 4 cyl. | \varnothing 105.50 -21.8 CD 61.3 TL 108.3 | 1 - 2.5 HK 1 - 2.0 1 - 4.5 | \varnothing 35.000 TL 87.50  | | TL 200.0 OD 109.0 FT 6.0 +1.0 FD 114.5 | | TEIKIN NO. LKFF 42184AG LKSF 42184AG |
|  | TEIKIN NO. 42184AG | TEIKIN NO. R 42184 | TEIKIN NO. P 39149 | TEIKIN NO. B 42184 | TEIKIN NO. LFF 42183 LSF 42183 | | |
| Surface Treatment Tin Coated | Bore Clearance MRC: 0.050 mm MP: 20.00 mm | REFERENCE NO. TF20-11-SAO | REFERENCE NO. TF01-11-SCO | REFERENCE NO. TF01-11-213 | REFERENCE NO. TFY0-10-311 TFY0-10-311A TFY0-10-311B TFY0-10-313 | | 94 |
| TM 4553 cc 4 cyl. | \varnothing 109.00 -20.9 CD 61.3 TL 107.3 | 1 - 3.0 HK 1 - 2.0 1 - 3.0 | \varnothing 35.000 TL 79.00  | | TL 202.0 OD 112.5 FT 6.0 +1.0 FD 118.0 | | TEIKIN NO. LKFF 42663AG LKSF 42663AG |
|  | TEIKIN NO. 42663AG | TEIKIN NO. R 42663 | TEIKIN NO. P 42663 | TEIKIN NO. B 42184 | TEIKIN NO. LFF 42663 LSF 42663 | | |
| Surface Treatment Tin Coated | Bore Clearance MRC: 0.050 mm MP: 15.00 mm | REFERENCE NO. TMY0-11-200 TMYO-11-SAO | REFERENCE NO. TMYO-11-SCO | REFERENCE NO. TF01-11-213 | REFERENCE NO. TMYO-10-313 TMYO-10-311 | | 95 |

SUITABLE FOR

MERCEDES BENZ

GASOLINE

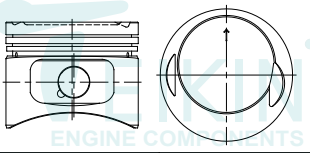

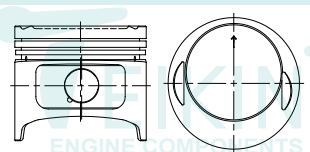
| ENGINE TYPE | PISTON | PISTON RING | PISTON PIN | PIN BUSHING | LINER | | LINER KIT SET |
|---|--|--------------------------------|---|-------------|---------|-----------|---------------|
| | | | | | FLANGED | NO FLANGE | |
| M102.945 2299 cc 2.3 SERIES 210, 310 1982-95 4 cyl. | \emptyset 95.50 -1.9 CD 43.3 TL 76.3 | 1 - 1.75 1 - 2.0 1 - 3.5 | \emptyset 22.000 TL 56.00  | | | | TEIKIN NO. |
|  ENGINE COMPONENTS | TEIKIN NO. | | TEIKIN NO. | | | | |
| Surface Treatment: Tin Coated Bore Clearance: MRC: 0.030 mm MP: 13.50 mm | REFERENCE NO. KS : 93 968 610 | | | | | | |
| | | | | | | | 5 |
| M102.980 2299 cc 230 E 1980-85 4 cyl. | \emptyset 95.50 -1.9 CD 43.3 TL 83.2 | 1 - 1.75 1 - 2.0 1 - 3.5 | \emptyset 24.000 TL 61.00  | | | | TEIKIN NO. |
|  ENGINE COMPONENTS | TEIKIN NO. | | TEIKIN NO. | | | | |
| Surface Treatment: Tin Coated Bore Clearance: MRC: 0.030 mm MP: 20.50 mm | REFERENCE NO. KS : 93 495 600 | | | | | | |
| | | | | | | | 6 |

M

| ENGINE TYPE | PISTON | PISTON RING | PISTON PIN | PIN BUSHING | LINER | | LINER KIT SET |
|--|--|--|------------------------------------|------------------------------|--|-----------|-----------------------------------|
| | | | | | FLANGED | NO FLANGE | |
| OM 601 1997 cc OM 602 4 cyl. OM 603 | \emptyset 87.00 -9.1 CD 44.85 TL 74.85 | 1 - 2.5 1 - 2.0 1 - 3.0 | \emptyset 26.000 TL 55.00 | | TL 148.6 OD 90.0 FT 4.7 FD 92.6 | | TEIKIN NO. LKSF 29603A |
| | TEIKIN NO. 29603A | TEIKIN NO. R 29603 | TEIKIN NO. P 29603 | TEIKIN NO. B 29603 | TEIKIN NO. LSF 29603A | | |
| Surface Treatment Bore Clearance Moly Skirt MRC: 0.030 mm MP: 10.00 mm | REFERENCE NO. KS: 94 330 600 MAHLE: 002 93 00 | REFERENCE NO. KS: 80001731000 MAHLE: 002 93 NO | | REFERENCE NO. | REFERENCE NO. KS: 89 193 190 MAHLE: 001 WV 09 | | 7 |
| OM 661 2299 cc 4 cyl. | \emptyset 89.00 -8.9 CD 44.6 TL 74.6 | 1 - 2.5 1 - 2.0 1 - 3.0 | \emptyset 26.000 TL 62.00 | | TL 156.5 OD 91.5 FT 4.7 FD 94.0 | | TEIKIN NO. LKSF 29602A |
| | TEIKIN NO. 29602A | TEIKIN NO. R 29602 | TEIKIN NO. P 29602 | TEIKIN NO. B 29602 | TEIKIN NO. LSF 29602A | | |
| Surface Treatment Bore Clearance Moly Skirt MRC: 0.030 mm MP: 12.00 mm | REFERENCE NO. KS: 91 372 600 MAHLE: 002 24 00 | REFERENCE NO. KS: 800017810000 MAHLE: 002 24 NO | | REFERENCE NO. | REFERENCE NO. KS: 89 456 190 MAHLE: 004 WV 14 | | 8 |
| OM 602 TURBO 2874 cc 5 cyl. | \emptyset 89.00 -16.7 CD 44.8 TL 74.8 | 1 - 2.5 1 - 2.0 1 - 3.0 | \emptyset 28.000 TL 70.00 | | TL 156.5 OD 91.5 FT 4.7 FD 94.0 | | TEIKIN NO. LKSF 29604AG |
| | TEIKIN NO. 29604AG | TEIKIN NO. R 29604 | TEIKIN NO. P G1114 | TEIKIN NO. B 29604 | TEIKIN NO. LSF 29604AG | | |
| Surface Treatment Bore Clearance Moly Skirt MRC: 0.040 mm MP: 13.00 mm | REFERENCE NO. KS: 94 823 700 MAHLE: 001 01 00 | REFERENCE NO. KS: 800017810000 MAHLE: 002 24 NO | | REFERENCE NO. | REFERENCE NO. KS: 89 456 190 MAHLE: 004 WV 14 | | 9 |
| 240D 2399 cc OM 616.910/912-914 4 cyl. OM 616.918/932-933/936/940 OM 616.942/944/960/963 OM 617.912-913/919/931-932 | \emptyset 90.90 -8.7 CD 48.3 TL 81.8 | 1 - 3.0 1 - 2.0 1 - 4.0 | \emptyset 26.000 TL 74.00 | | | | TEIKIN NO. |
| | TEIKIN NO. 29118 29118A | | TEIKIN NO. P 44215 | | | | |
| Surface Treatment Bore Clearance Chromated Moly Skirt MRC: 0.030 mm MP: 10.00 mm | REFERENCE NO. KS : 93 444 600 | | | | | | 10 |







SUITABLE FOR

MERCEDES BENZ

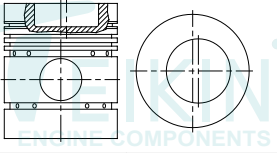
DIESEL

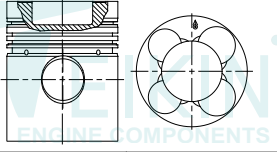

| ENGINE TYPE | PISTON | PISTON RING | PISTON PIN | PIN BUSHING | LINER | | LINER KIT SET |
|---|---|----------------------------------|--|-------------|---------|-----------|---------------|
| | | | | | FLANGED | NO FLANGE | |
| 911, OM - 352 5675 cc 6 cyl.  | \emptyset 97.00 -20.0 CD 65.2 TL 115.7 | 1 - 3.0 FK 2 - 3.0 2 - 5.5 | \emptyset 36.000 TL 82.50  | | | | TEIKIN NO. |
| Surface Treatment Chromated Moly Skirt Bore Clearance MRC: 0.100 mm MP: 23.00 mm | TEIKIN NO. 29110 29110A REFERENCE NO. KS : 90 274 800 | | TEIKIN NO. P 29110 | | | | 11 |
| OM - 355 6 cyl.  | \emptyset 128.00 -27.1 CD 90.2 TL 161.3 | 1 - 3.5 FK 2 - 3.5 1 - 6.5 | \emptyset 48.000 TL 108.00  | | | | TEIKIN NO. |
| Surface Treatment Chromated Moly Skirt Bore Clearance MRC: 0.110 mm MP: 37.00 mm | TEIKIN NO. 29106 29106A REFERENCE NO. KS : 93 568 600 | | TEIKIN NO. P 29106 | | | | 12 |

M

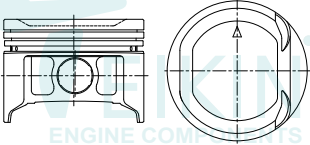
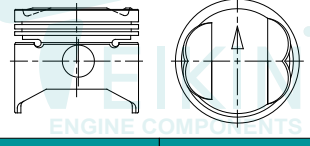
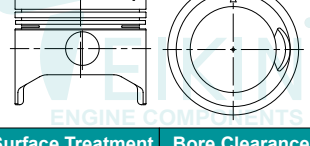
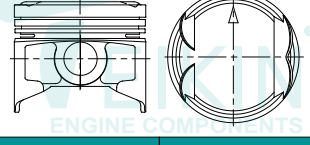
| ENGINE TYPE | PISTON | PISTON RING | PISTON PIN | PIN BUSHING | LINER | | LINER KIT SET |
|---|--|-------------------------------|--------------------------------|-------------|---------|-----------|---------------|
| | | | | | FLANGED | NO FLANGE | |
| 4A31 4 cyl.  Surface Treatment Bore Clearance Tin Coated MRC: 0.030 mm MP: 10.00 mm | \emptyset 66.00 -3.1 CD 26.6 TL 48.6 | 1 - 1.0 1 - 1.2 1 - 2.5 | \emptyset 16.000 TL 46.00 | | | | TEIKIN NO. |
| | TEIKIN NO. 43680 | | TEIKIN NO. P 43680 | | | | |
| | REFERENCE NO. MD333030 | | | | | | |
| | | | | | | | 1 |
| 4G11 1244 cc 4 cyl.  Surface Treatment Bore Clearance Tin Coated MRC: 0.010 mm MP: 10.00 mm | \emptyset 69.50 +0.8 CD 29.0 TL 58.8 | 2 - 1.5 1 - 4.0 | \emptyset 18.000 TL 60.00 | | | | TEIKIN NO. |
| | TEIKIN NO. 43616 (43254) | | TEIKIN NO. P 32601 | | | | |
| | REFERENCE NO. MD030312 | | | | | | |
| | | | | | | | 2 |
| 2G23 L100, L103 546 cc 2 cyl.  Surface Treatment Bore Clearance Tin Coated MRC: 0.030 mm MP: 17.00 mm | \emptyset 70.00 +2.1 CD 27.0 TL 59.0 | 2 - 1.5 1 - 2.5 | \emptyset 18.000 TL 61.00 | | | | TEIKIN NO. |
| | TEIKIN NO. 43176 | | TEIKIN NO. P 43187 | | | | |
| | REFERENCE NO. MD019851 | | | | | | |
| | | | | | | | 3 |
| 4G13 1298 cc 4 cyl.  Surface Treatment Bore Clearance None MRC: 0.030 mm MP: 15.00 mm | \emptyset 71.00 +1.7 CD 29.1 TL 59.7 | 1 - 1.2 1 - 1.5 1 - 3.0 | \emptyset 18.000 TL 56.00 | | | | TEIKIN NO. |
| | TEIKIN NO. 43600 (43246) | | TEIKIN NO. P 30104 | | | | |
| | REFERENCE NO. MD172036 | | | | | | |
| | | | | | | | 4 |



SUITABLE FOR

MITSUBISHI

GASOLINE

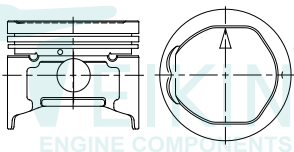
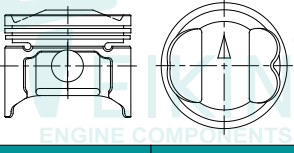
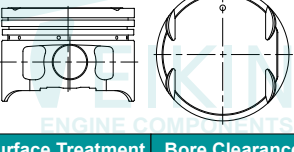
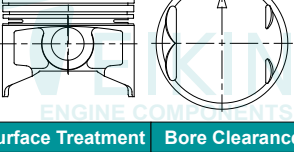

| ENGINE TYPE | PISTON | PISTON RING | PISTON PIN | PIN BUSHING | LINER | | LINER KIT SET |
|---|--|-------------------------------|---------------------------------|-------------|---------|-----------|---------------|
| | | | | | FLANGED | NO FLANGE | |
| 4G13-II 1298 cc 4 cyl.  Surface Treatment: Tin Coated Bore Clearance: MRC: 0.030 mm, MP: 14.00 mm | \varnothing 71.00 -1.10 CD 29.3 TL 58.3 | 2 - 1.5 1 - 4.0 | \varnothing 18.00 TL 59.00 | | | | TEIKIN NO. |
| | TEIKIN NO. 43257 (43603) | | TEIKIN NO. P 46141 | | | | |
| | REFERENCE NO. MD099759 | | | | | | |
| | | | | | | | 5 |
| 4G13-III 1298 cc 4 cyl.  Surface Treatment: Tin Coated Bore Clearance: MRC: 0.030 mm, MP: 14.50 mm | \varnothing 71.00 +2.7 CD 28.8 TL 60.5 | 2 - 1.5 1 - 4.0 | \varnothing 18.00 TL 59.00 | | | | TEIKIN NO. |
| | TEIKIN NO. 43652 | | TEIKIN NO. P 46141 | | | | |
| | REFERENCE NO. MD074677 MD074680 MD074676 23410-21000 | | | | | | |
| | | | | | | | 6 |
| 4G13-IV 4 cyl.  Surface Treatment: None Bore Clearance: MRC: 0.030 mm, MP: 9.00 mm | \varnothing 71.00 +0.30 CD 28.7 TL 50.0 | 1 - 1.2 1 - 1.5 1 - 2.8 | \varnothing 18.00 TL 56.00 | | | | TEIKIN NO. |
| | TEIKIN NO. 43282 | | TEIKIN NO. P 30104 | | | | |
| | REFERENCE NO. MD351586 | | | | | | |
| | | | | | | | 7 |
| 4G17 1300 cc T-120SS 4 cyl.  Surface Treatment: None Bore Clearance: MRC: 0.030 mm, MP: 15.00 mm | \varnothing 72.20 +0.5 CD 29.0 TL 58.5 | 1 - 1.2 1 - 1.5 1 - 3.0 | \varnothing 18.00 TL 56.00 | | | | TEIKIN NO. |
| | TEIKIN NO. 43216 | | TEIKIN NO. P 30104 | | | | |
| | REFERENCE NO. MD173577A | | | | | | |
| | | | | | | | 8 |

M



SUITABLE FOR

MITSUBISHI

GASOLINE

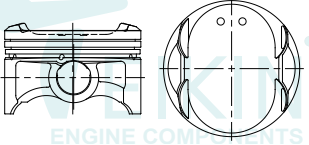
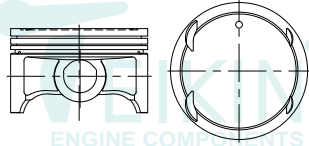
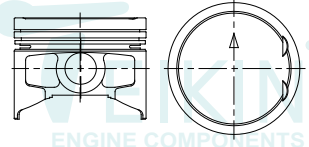
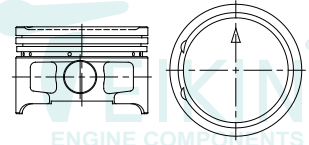

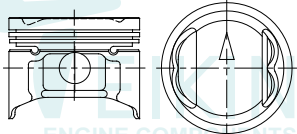
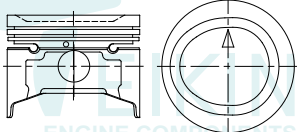
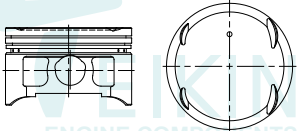
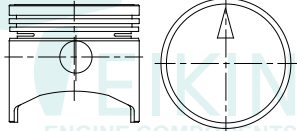
| ENGINE TYPE | PISTON | PISTON RING | PISTON PIN | PIN BUSHING | LINER | | LINER KIT SET |
|--|--|-------------------------------|--------------------------------|-------------|---------|-----------|---------------|
| | | | | | FLANGED | NO FLANGE | |
| 3A92 1193 cc 3 cyl. | \emptyset 75.00 +3.9 CD 26.0 TL 49.9 | 1 - 1.0 1 - 1.2 1 - 2.0 | \emptyset 18.000 TL 50.00 | | | | TEIKIN NO. |
|  | TEIKIN NO. 43296 | | TEIKIN NO. P 45136 | | | | |
| Surface Treatment Bore Clearance Moly Skirt Anodized Crown 1st Ring Anodized MRC: 0.030 mm MP: 8.50 mm | REFERENCE NO. 1110C337 | | | | | | 13 |
| 4A91 1499 cc 4 cyl. COLT - LANCER LANCER SPORTBACK CX2A - CY2A - Z36A (07-) | \emptyset 75.00 -0.6 CD 26.1 TL 46.1 | 1 - 1.2 1 - 0.8 1 - 2.0 | \emptyset 18.010 TL 50.00 | | | | TEIKIN NO. |
|  | TEIKIN NO. 43696 | | TEIKIN NO. P 43696 | | | | |
| Surface Treatment Bore Clearance Tin Coated MRC: 0.030 mm MP: 10.00 mm | REFERENCE NO. MN195611 | | | | | | 14 |
| 4G15 1468 cc 4 cyl. MIRAGE 1991-92 F.I., SOHC, 12V HYUNDAI X3 | \emptyset 75.50 -0.5 CD 29.0 TL 58.0 | 1 - 1.2 1 - 1.5 1 - 3.0 | \emptyset 18.000 TL 56.00 | | | | TEIKIN NO. |
|  | TEIKIN NO. 43217 | | TEIKIN NO. P 30104 | | | | |
| Surface Treatment Bore Clearance Tin Coated MRC: 0.020 mm MP: 14.00 mm | REFERENCE NO. MD320435 MD066396 MD144901 | | | | | | 15 |
| 4G15-II 1468 cc 4 cyl. MIRAGE 1997-99 SOHC 12 V | \emptyset 75.50 -1.6 CD 28.7 TL 49.7 | 1 - 1.2 1 - 1.5 1 - 2.8 | \emptyset 18.000 TL 56.00 | | | | TEIKIN NO. |
|  | TEIKIN NO. 43248 | | TEIKIN NO. P 30104 | | | | |
| Surface Treatment Bore Clearance None MRC: 0.030 mm MP: 9.30 mm | REFERENCE NO. MD332841 | | | | | | 16 |

| ENGINE TYPE | PISTON | PISTON RING | PISTON PIN | PIN BUSHING | LINER | | LINER KIT SET |
|---|---|------------------------|---|-------------|---------|-----------|---------------|
| | | | | | FLANGED | NO FLANGE | |
| G15B 1468 cc 4 cyl. MIRAGE 1985-88 PRECIS 1987-89 HYUNDAI G4AJ, X1, G4DJ 1986-89  Surface Treatment: Tin Coated Bore Clearance: MRC: 0.030 mm, MP: 16.00 mm | \emptyset 75.50 -0.7 CD 29.1 TL 58.3 | 2 - 1.5 1 - 4.0 | \emptyset 18.000 TL 61.00 | | | | TEIKIN NO. |
| | TEIKIN NO. 43187 | | TEIKIN NO. P 43187 | | | | |
| | REFERENCE NO. MD074715 23410-21114 | | | | | | 17 |
| G15B-II 1468 cc 4 cyl.  Surface Treatment: Tin Coated Bore Clearance: MRC: 0.030 mm, MP: 15.00 mm | \emptyset 75.50 -3.6 CD 29.1 TL 58.3 | 2 - 1.5 1 - 4.0 | \emptyset 18.000 TL 61.00 | | | | TEIKIN NO. |
| | TEIKIN NO. 43272 (43653) | | TEIKIN NO. P 43187 | | | | |
| | REFERENCE NO. MD099770 MD099769 | | | | | | 18 |
| 4G18 1584 cc 4 cyl.  Surface Treatment: None Bore Clearance: MRC: 0.030 mm, MP: 9.50 mm | \emptyset 76.00 -1.5 CD 26.0 TL 47.0 | 2 - 1.2 1 - 2.5 | \emptyset 18.000 TL 56.00 | | | | TEIKIN NO. |
| | TEIKIN NO. 43281 | | TEIKIN NO. P 30104 | | | | |
| | REFERENCE NO. MD366902 MD367775 MD367776 MD367777 | | | | | | 19 |
| 4G41R NEW 1378 cc 4 cyl.  Surface Treatment: Tin Coated Bore Clearance: MRC: 0.030 mm, MP: 23.60 mm | \emptyset 76.50 +0.2 CD 30.6 TL 69.2 | 2 - 2.0 1 - 4.0 | \emptyset 19.000 TL 64.00  | | | | TEIKIN NO. |
| | TEIKIN NO. 43144 | | TEIKIN NO. P 43132 | | | | |
| | REFERENCE NO. MD011940 MD011941 | | | | | | 20 |

M

SUITABLE FOR

MITSUBISHI

GASOLINE

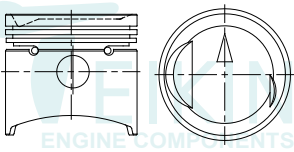
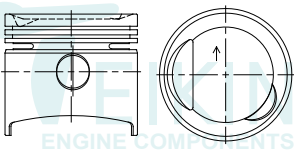
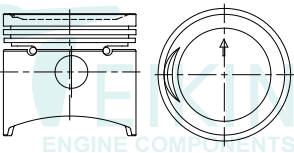
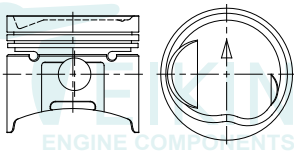

| ENGINE TYPE | PISTON | PISTON RING | PISTON PIN | PIN BUSHING | LINER | | LINER KIT SET |
|---|--|--------------------|----------------------------------|-------------|---------|-----------|---------------|
| | | | | | FLANGED | NO FLANGE | |
| 4G32 1597 cc L200 4 cyl. HYUNDAI 1600 CC  | \varnothing 76.90 -2.8 CD 33.6 TL 70.5 | 2 - 2.0 1 - 4.0 | \varnothing 19.000 TL 64.00 | | | | TEIKIN NO. |
| Surface Treatment Tin Coated | Bore Clearance MRC: 0.030 mm MP: 19.50 mm | | | | | | |
| | TEIKIN NO. 43132 | | TEIKIN NO. P 43132 | | | | 21 |
| | REFERENCE NO. MD008851 23410-11621 MD004761 | | | | | | |
| 4G32 NEW 1597 cc L200 4 cyl. HYUNDAI 1600 CC  | \varnothing 76.90 -2.9 CD 33.5 TL 70.5 | 2 - 2.0 1 - 4.0 | \varnothing 19.000 TL 64.00 | | | | TEIKIN NO. |
| Surface Treatment None | Bore Clearance MRC: 0.030 mm MP: 20.00 mm | | | | | | |
| | TEIKIN NO. 43132N | | TEIKIN NO. P 43132 | | | | 22 |
| | REFERENCE NO. MD008851 23410-11621 MD004761 | | | | | | |
| 4G32-III 1597 cc 4 cyl.  | \varnothing 76.90 -3.3 CD 33.8 TL 70.7 | 2 - 2.0 1 - 4.0 | \varnothing 19.000 TL 64.00 | | | | TEIKIN NO. |
| Surface Treatment Tin Coated | Bore Clearance MRC: 0.030 mm MP: 19.50 mm | | | | | | |
| | TEIKIN NO. 43224 | | TEIKIN NO. P 43132 | | | | 23 |
| | REFERENCE NO. MD004670 | | | | | | |
| 4G32-M 1597 cc 4 cyl.  | \varnothing 76.90 -2.4 CD 34.0 TL 68.0 | 2 - 1.5 1 - 4.0 | \varnothing 19.000 TL 64.00 | | | | TEIKIN NO. |
| Surface Treatment None | Bore Clearance MRC: 0.030 mm MP: 16.00 mm | | | | | | |
| | TEIKIN NO. 43221 | | TEIKIN NO. P 43132 | | | | 24 |
| | REFERENCE NO. MD105495 | | | | | | |

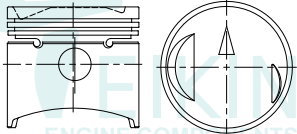
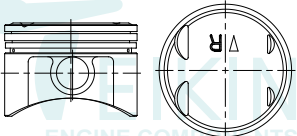
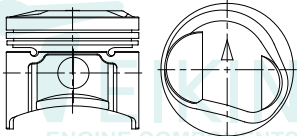
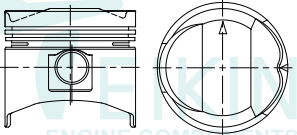
| ENGINE TYPE | PISTON | PISTON RING | PISTON PIN | PIN BUSHING | LINER | | LINER KIT SET |
|---|--|--|--------------------------------|-------------|---------|-----------|--|
| | | | | | FLANGED | NO FLANGE | |
| G32S 1597 cc 4 cyl. | \emptyset 76.90 -0.4 CD 33.5 TL 70.5 | 2 - 2.0 1 - 4.0 | \emptyset 19.000 TL 64.00 | | | | TEIKIN NO. 25 |
|  | TEIKIN NO. 43656 | | TEIKIN NO. P 43132 | | | | |
| Surface Treatment Tin Coated | Bore Clearance MRC: 0.020 mm MP: 28.00 mm | REFERENCE NO. MD008861 MD004680 MD004767 MD008860 | | | | | |
| | | | | | | | |
| 6A12 1999 cc 6 cyl. | \emptyset 78.40 +1.0 CD 28.7 TL 55.2 | 2 - 1.2 1 - 2.8 | \emptyset 19.000 TL 58.00 | | | | TEIKIN NO. 26 |
|  | TEIKIN NO. 43677 | | TEIKIN NO. P 32125 | | | | |
| Surface Treatment Tin Coated Anodized Crown | Bore Clearance MRC: 0.030 mm MP: 12.00 mm | REFERENCE NO. MD352494 (R/L) MD356498 (R/L) | | | | | |
| | | | | | | | |
| 4G37 1755 cc 4 cyl. | \emptyset 80.60 +3.8 CD 34.0 TL 71.8 | 2 - 1.5 1 - 4.0 | \emptyset 19.000 TL 64.00 | | | | TEIKIN NO. 27 |
|  | TEIKIN NO. 43219 | | TEIKIN NO. P 43132 | | | | |
| Surface Treatment Tin Coated | Bore Clearance MRC: 0.020 mm MP: 16.50 mm | REFERENCE NO. MD100416 | | | | | |
| | | | | | | | |
| 4G62 1795 cc 4 cyl. | \emptyset 80.60 +1.3 CD 35.0 TL 73.1 | 2 - 2.0 1 - 4.0 | \emptyset 21.000 TL 72.50 | | | | TEIKIN NO. 28 |
|  | TEIKIN NO. 43154 | | TEIKIN NO. P 43155 | | | | |
| Surface Treatment Tin Coated | Bore Clearance MRC: 0.030 mm MP: 19.30 mm | REFERENCE NO. MD040571 | | | | | |
| | | | | | | | |



SUITABLE FOR

MITSUBISHI

GASOLINE

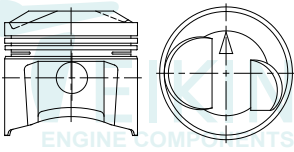
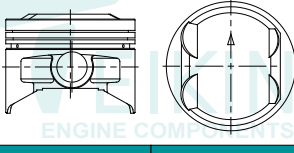
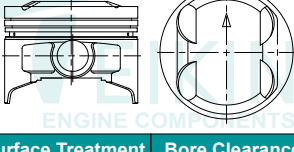
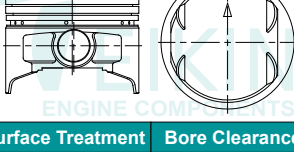

| ENGINE TYPE | PISTON | PISTON RING | PISTON PIN | PIN BUSHING | LINER | | LINER KIT SET |
|---|--|------------------------|------------------------------------|-------------|---------|-----------|---------------|
| | | | | | FLANGED | NO FLANGE | |
| G37B 4G37 | 1755 cc 4 cyl. Ø 80.60 +7.0 CD 33.5 TL 75.5 | 2 - 1.5 1 - 4.0 | Ø 19.000 TL 64.00 | | | | TEIKIN NO. |
|  | TEIKIN NO. 43195 | | TEIKIN NO. P 43132 | | | | |
| Surface Treatment None | Bore Clearance MRC: 0.030 mm MP: 14.00 mm | | REFERENCE NO. MD074210 | | | | |
| | | | | | | | 29 |
| 4G92S | 1597 cc 4 cyl. Ø 81.00 +2.3 CD 30.0 TL 61.4 | 2 - 1.2 1 - 2.8 | Ø 19.000 TL 61.00 | | | | TEIKIN NO. |
|  | TEIKIN NO. 43671 | | TEIKIN NO. P 45127 | | | | |
| Surface Treatment Tin Coated | Bore Clearance MRC: 0.030 mm MP: 15.00 mm | | REFERENCE NO. MD191343 | | | | |
| | | | | | | | 30 |
| 4G92S-H | 1597 cc 4 cyl. Ø 81.00 +3.1 CD 30.0 TL 62.1 | 2 - 1.2 1 - 2.8 | Ø 19.000 TL 58.00 | | | | TEIKIN NO. |
|  | TEIKIN NO. 43657 | | TEIKIN NO. P32125 | | | | |
| Surface Treatment Tin Coated | Bore Clearance MRC: 0.030 mm MP: 16.50 mm | | REFERENCE NO. MD329140-6 | | | | |
| | | | | | | | 31 |
| 4G93 | 1834 cc 4 cyl. Ø 81.00 +1.0 CD 30.1 TL 60.1 | 2 - 1.2 1 - 2.8 | Ø 19.000 TL 58.00 | | | | TEIKIN NO. |
|  | TEIKIN NO. 43658 | | TEIKIN NO. P 32125 | | | | |
| Surface Treatment Tin Coated | Bore Clearance MRC: 0.030 mm MP: 16.50 mm | | REFERENCE NO. MD329139 | | | | |
| | | | | | | | 32 |

M

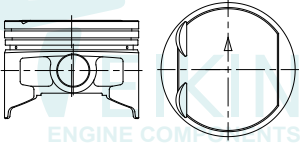
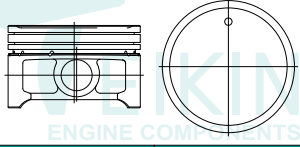
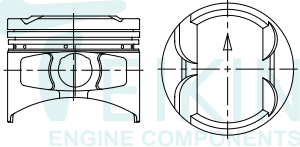
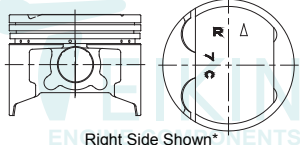
| ENGINE TYPE | PISTON | PISTON RING | PISTON PIN | PIN BUSHING | LINER | | LINER KIT SET |
|--|---|-------------------------------|--------------------------------|-------------|---------|-----------|---------------|
| | | | | | FLANGED | NO FLANGE | |
| 4G93-II 1834 cc 4 cyl. | \emptyset 81.00 +0.2 CD 30.8 TL 60.0 | 2 - 1.2 1 - 2.8 | \emptyset 19.000 TL 58.00 | | | | TEIKIN NO. |
|  | TEIKIN NO. 43679 | TEIKIN NO. P 32125 | | | | | |
| Surface Treatment Bore Clearance Tin Coated MRC: 0.030 mm MP: 16.50 mm | REFERENCE NO. MD190610 MD318097 | | | | | | |
| | | | | | | 33 | |
| 4G94 1999 cc 4 cyl. 2.0L SOHC 16V LANCER 02-05 | \emptyset 81.50 -1.2 CD 30.4 TL 50.4 | 2 - 1.2 1 - 2.5 | \emptyset 19.000 TL 58.00 | | | | TEIKIN NO. |
|  | TEIKIN NO. 43288 | TEIKIN NO. P 32125 | | | | | |
| Surface Treatment Bore Clearance Tin Coated MRC: 0.030 mm MP: 7.00 mm | REFERENCE NO. MD375975 MN187171 MN187172 MD375974 | | | | | | |
| | | | | | | 34 | |
| 4G61 1595 cc 4 cyl. MIRAGE 1991-92 DOHC 16 V HYUNDAI G4CR, J1 | \emptyset 82.30 +1.7 CD 32.1 TL 66.1 | 1 - 1.2 1 - 1.5 1 - 3.0 | \emptyset 21.000 TL 66.00 | | | | TEIKIN NO. |
|  | TEIKIN NO. 43250 | TEIKIN NO. P 44121 | | | | | |
| Surface Treatment Bore Clearance None MRC: 0.030 mm MP: 17.00 mm | REFERENCE NO. MD129932 23410-33000 23410-33010 23410-33020 | | | | | | |
| | | | | | | 35 | |
| 6G73 2497 cc 6 cyl. CHRYSLER STRATUS SEBRING, CIRRUS, AVENGER 1995-98 | \emptyset 83.50 +0.2 CD 31.6 TL 64.1 | 1 - 1.2 1 - 1.5 1 - 3.0 | \emptyset 22.000 TL 64.00 | | | | TEIKIN NO. |
|  | TEIKIN NO. 43263 | TEIKIN NO. P 43220 | | | | | |
| Surface Treatment Bore Clearance None MRC: 0.030 mm MP: 15.50 mm | REFERENCE NO. MD309393 (R) MD309399 (L) | | | | | | |
| | | | | | | 36 | |

M

SUITABLE FOR

MITSUBISHI

GASOLINE

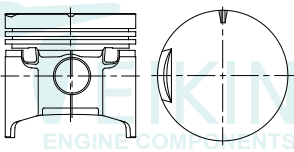
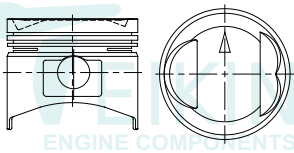
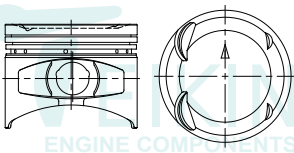
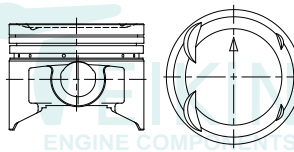

| ENGINE TYPE | PISTON | PISTON RING | PISTON PIN | PIN BUSHING | LINER | | LINER KIT SET |
|--|--|-------------------------------|----------------------|-------------|---------|-----------|---------------|
| | | | | | FLANGED | NO FLANGE | |
| 4G52 1995 cc 1973 4 cyl. | Ø 84.00 -2.2 CD 40.2 TL 79.8 | 2 - 2.0 1 - 4.0 | Ø 22.000 TL 75.00 | | | | TEIKIN NO. |
|  | TEIKIN NO. | | TEIKIN NO. | | | | |
| Surface Treatment: None Bore Clearance: MRC: 0.070 mm, MP: 22.00 mm | REFERENCE NO. MD021058 MD021000 MD021063 MD021192 | | | | | | 37 |
| 4G63 OLD 2555 cc T/C GALANT SIGMA 4 cyl. | Ø 85.00 -1.0 CD 35.1 TL 72.0 | 2 - 2.0 1 - 4.0 | Ø 21.000 TL 72.50 | | | | TEIKIN NO. |
|  | TEIKIN NO. | | TEIKIN NO. | | | | |
| Surface Treatment: Tin Coated Bore Clearance: MRC: 0.030 mm, MP: 19.00 mm | REFERENCE NO. MD041564 MD040591 | | | | | | 38 |
| 4G63D 1997 cc ECLIPSE 1989-92 F.I., DOHC, 16 V HYUNDAI Y2, G4CF SONATA 1992-98 4 cyl. | Ø 85.00 -2.6 CD 34.9 TL 66.9 | 1 - 1.2 1 - 1.5 1 - 3.0 | Ø 21.000 TL 66.00 | | | | TEIKIN NO. |
|  | TEIKIN NO. | | TEIKIN NO. | | | | |
| Surface Treatment: Tin Coated Bore Clearance: MRC: 0.020 mm, MP: 17.00 mm | REFERENCE NO. MD129922 23410-33100 23410-33110 23410-33120 | | | | | | 39 |
| 4G63DK 1997 cc 1993-94 4 cyl. F.I., DOHC ECLIPSE 16V | Ø 85.00 -2.3 CD 35.0 TL 67.0 | 1 - 1.2 1 - 1.5 1 - 3.0 | Ø 22.000 TL 62.00 | | | | TEIKIN NO. |
|  | TEIKIN NO. | | TEIKIN NO. | | | | |
| Surface Treatment: Tin Coated Bore Clearance: MRC: 0.020 mm, MP: 14.50 mm | REFERENCE NO. MD190262 | | | | | | 40 |

SUITABLE FOR

MITSUBISHI

GASOLINE



| ENGINE TYPE | PISTON | PISTON RING | PISTON PIN | PIN BUSHING | LINER | | LINER KIT SET |
|---|---|-------------------------------|----------------------------------|-------------|---------|-----------|---|
| | | | | | FLANGED | NO FLANGE | |
| G63B 1997 cc 4G63 NEW 4 cyl. | \varnothing 85.00 +1.8 CD 35.0 TL 73.7 | 2 - 2.0 1 - 4.0 | \varnothing 21.000 TL 72.50 | | | | TEIKIN NO. REFERENCE NO. MD040821 |
| | TEIKIN NO. 43207 | TEIKIN NO. P 43155 | | | | | |
| | REFERENCE NO. MD040821 | | | | | | |
| | Surface Treatment Bore Clearance None MRC: 0.030 mm MP: 19.95 mm | | | | | | |
| 45 | | | | | | | |
| G63B-II 1997 cc 4 cyl. | \varnothing 85.00 -1.8 CD 35.4 TL 72.4 | 2 - 1.5 1 - 4.0 | \varnothing 21.000 TL 72.50 | | | | TEIKIN NO. REFERENCE NO. MD100372 |
| | TEIKIN NO. 43621 (43262) | TEIKIN NO. P 43155 | | | | | |
| | REFERENCE NO. MD100372 | | | | | | |
| | Surface Treatment Bore Clearance Tin Coated MRC: 0.030 mm MP: 19.00 mm | | | | | | |
| 46 | | | | | | | |
| G63DH 1997 cc 4 cyl. | \varnothing 85.00 -0.6 CD 35.0 TL 67.0 | 1 - 1.2 1 - 1.5 1 - 3.0 | \varnothing 21.000 TL 66.00 | | | | TEIKIN NO. REFERENCE NO. MD129942 |
| | TEIKIN NO. 43676 | TEIKIN NO. P 44121 | | | | | |
| | REFERENCE NO. MD129942 | | | | | | |
| | Surface Treatment Bore Clearance Tin Coated MRC: 0.030 mm MP: 17.50 mm | | | | | | |
| 47 | | | | | | | |
| 4B11 1998 cc 4 cyl. ASX - DELICA GALLANT - LANCER OUTLANDER, CV4W - CW4W DOHC 16V | \varnothing 86.00 +0.3 CD 27.5 TL 50.8 | 2 - 1.2 1 - 2.0 | \varnothing 21.000 TL 58.00 | | | | TEIKIN NO. REFERENCE NO. 1110B478 1110B479 1110B480 |
| | TEIKIN NO. 43692 | TEIKIN NO. P 43692 | | | | | |
| | REFERENCE NO. 1110B478 1110B479 1110B480 | | | | | | |
| | Surface Treatment Bore Clearance Tin Coated MRC: 0.030 mm MP: 10.00 mm | | | | | | |
| 48 | | | | | | | |

M

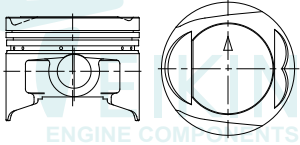
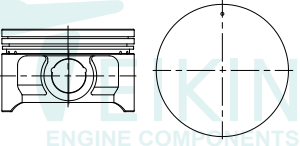
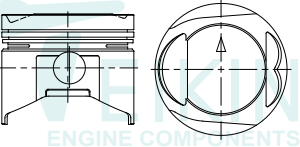
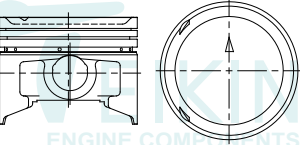
| ENGINE TYPE | PISTON | PISTON RING | PISTON PIN | PIN BUSHING | LINER | | LINER KIT SET |
|---|--|-------------------------------|---------------------------------|-------------|---------|-----------|---------------|
| | | | | | FLANGED | NO FLANGE | |
| 4G64 2350 cc PICKUP, MIGHTY MAX F.I., SOHC 8V 1993-96 4 cyl. | \emptyset 86.50 +0.3 CD 35.1 TL 67.4 | 1 - 1.2 1 - 1.5 1 - 3.0 | \emptyset 22.000 TL 62.000 | | | | TEIKIN NO. |
|  | TEIKIN NO. 43228 | | TEIKIN NO. P 43222 | | | | |
| Surface Treatment Bore Clearance Tin Coated MRC: 0.030 mm MP: 14.60 mm | REFERENCE NO. MD188998 | | | | | | |
| | | | | | | | |
| 4G64-II 2350 cc GALANT, ECLIPSE 1999-2002 F.I., SOHC 16V 4 cyl. | \emptyset 86.50 CD 30.5 TL 53.0 | 1 - 1.2 1 - 1.5 1 - 2.8 | \emptyset 22.000 TL 62.000 | | | | TEIKIN NO. |
|  | TEIKIN NO. 43270 | | TEIKIN NO. P 43222 | | | | |
| Surface Treatment Bore Clearance None MRC: 0.020 mm MP: 8.50 mm | REFERENCE NO. MD357067 | | | | | | |
| | | | | | | | |
| 4G64N 2350 cc HYUNDAI Y2, G4 CS F.I., SOHC 12V 4 cyl. | \emptyset 86.50 +0.4 CD 35.0 TL 72.4 | 2 - 1.5 1 - 4.0 | \emptyset 21.000 TL 72.500 | | | | TEIKIN NO. |
|  | TEIKIN NO. 43258 (43601) | | TEIKIN NO. P 43155 | | | | |
| Surface Treatment Bore Clearance Tin Coated MRC: 0.030 mm MP: 20.50 mm | REFERENCE NO. MD105377 23410-32600/10/20/40 | | | | | | |
| | | | | | | | |
| 4G64S 2350 cc 1993-96 F.I., SOHC 4 EXPO, GALANT 4 cyl. | \emptyset 86.50 -4.3 CD 35.0 TL 67.1 | 1 - 1.2 1 - 1.5 1 - 2.8 | \emptyset 22.000 TL 62.000 | | | | TEIKIN NO. |
|  | TEIKIN NO. 43225 | | TEIKIN NO. P 43222 | | | | |
| Surface Treatment Bore Clearance Tin Coated MRC: 0.020 mm MP: 14.00 mm | REFERENCE NO. MD303071 MD188115 MD303074 | | | | | | |
| | | | | | | | |

M

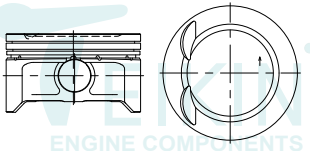
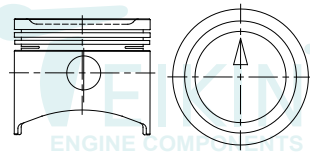
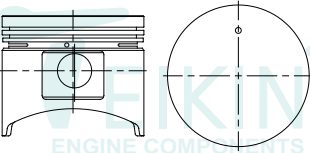
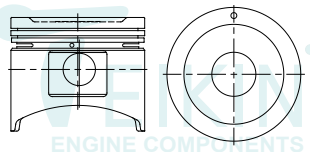
| ENGINE TYPE | PISTON | PISTON RING | PISTON PIN | PIN BUSHING | LINER | | LINER KIT SET |
|---|--|------------------------------|--------------------------------|-------------|---------|-----------|---------------|
| | | | | | FLANGED | NO FLANGE | |
| 4B12 2359 cc 4 cyl. LANCER - DELICA OUTLANDER CV5W - CW5W CX5A - CY5A  | \emptyset 88.00 -1.7 CD 27.5 TL 51.5 | 2 - 1.2 1 - 2.0 | \emptyset 21.000 TL 58.00 | | | | TEIKIN NO. |
| Surface Treatment Bore Clearance Tin Coated MRC: 0.030 mm MP: 10.00 mm | TEIKIN NO. 43694 | TEIKIN NO. P 43692 | | | | | |
| | REFERENCE NO. 1110B365 1110B366 1110B367 1110B483 | | | | | | |
| | | | | | | | |
| 4G53 OLD 2384 cc 4 cyl. FORKLIFT 3T  | \emptyset 88.00 -4.3 CD 35.1 TL 75.0 | 2 - 2.0 1 - 4.0 | \emptyset 22.000 TL 75.00 | | | | TEIKIN NO. |
| Surface Treatment Bore Clearance None MRC: 0.030 mm MP: 22.50 mm | TEIKIN NO. 43151 | TEIKIN NO. P 46189 | | | | | |
| | REFERENCE NO. MD024901 MD024921 | | | | | | |
| | | | | | | | |
| 4G54 2555 cc 4 cyl. DASH GALANT MONTERO 1983, CHRYSLER 400 1982-83, 600, CARAVAN 1983-84, CHALLENGER 1981-84  | \emptyset 91.10 CD 35.4 TL 77.3 | 2 - 2.0 1 - 4.0 | \emptyset 22.000 TL 79.00 | | | | TEIKIN NO. |
| Surface Treatment Bore Clearance Tin Coated MRC: 0.030 mm MP: 20.50 mm | TEIKIN NO. 43153 | TEIKIN NO. P 43153 | | | | | |
| | REFERENCE NO. MD026921 | | | | | | |
| | | | | | | | |
| 4G54C 4 cyl.  | \emptyset 91.10 -3.0 CD 35.4 TL 77.4 | 2 - 1.5 1 - 4.0 | \emptyset 22.000 TL 79.00 | | | | TEIKIN NO. |
| Surface Treatment Bore Clearance Tin Coated MRC: 0.030 mm MP: 20.50 mm | TEIKIN NO. 43292 | TEIKIN NO. P 43153 | | | | | |
| | REFERENCE NO. MD080394 | | | | | | |
| | | | | | | | |



SUITABLE FOR

MITSUBISHI

GASOLINE

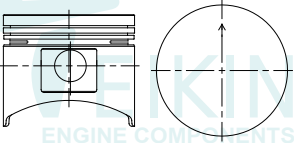
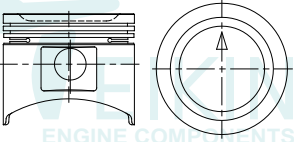
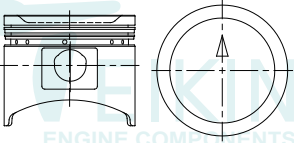
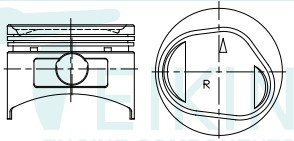

| ENGINE TYPE | PISTON | PISTON RING | PISTON PIN | PIN BUSHING | LINER | | LINER KIT SET |
|---|--|--------------------|-----------------------|-------------|---------|-----------|---------------|
| | | | | | FLANGED | NO FLANGE | |
| G54B, RWD 2555 cc 4 cyl. MONTERO 1983-89 SOHC, 12 V CHRYSLER CARAVAN 1983-87 RELIANT 1985-88,  | Ø 91.10 CD 35.5 TL 77.5 | 2 - 1.5 1 - 4.0 | Ø 22.000 TL 79.00 | | | | TEIKIN NO. |
| Surface Treatment Bore Clearance Tin Coated MRC: 0.020 mm MP: 20.70 mm | TEIKIN NO. 43233 REFERENCE NO. MD071172 | | TEIKIN NO. P 43153 | | | | 61 |
| G54B-II 2555 cc 4 cyl.  | Ø 91.10 -5.0 CD 35.0 TL 77.0 | 2 - 2.0 1 - 4.0 | Ø 22.000 TL 79.00 | | | | TEIKIN NO. |
| Surface Treatment Bore Clearance Tin Coated MRC: 0.030 mm MP: 21.00 mm | TEIKIN NO. 43654 REFERENCE NO. MD024946/47 MD024990/91 MD026860/61 MD026870/71 | | TEIKIN NO. P 43153 | | | | 62 |
| G54BT 2555 cc 4 cyl.  | Ø 91.10 -5.2 CD 35.0 TL 76.9 | 2 - 1.5 1 - 4.0 | Ø 22.000 TL 79.00 | | | | TEIKIN NO. |
| Surface Treatment Bore Clearance Tin Coated MRC: 0.030 mm MP: 20.50 mm | TEIKIN NO. 43273 REFERENCE NO. MD061248 MD128450 | | TEIKIN NO. P 43153 | | | | 63 |
| 6G72 2972 cc 6 cyl. GALANT SIGMA 1988-90 MONTERO PICKUP 1989-95 F.I., SOHC, V6, HYUNDAI 3000 CC  | Ø 91.10 -3.4 CD 31.7 TL 67.5 | 2 - 1.5 1 - 4.0 | Ø 22.000 TL 66.00 | | | | TEIKIN NO. |
| Right Side Shown* Surface Treatment Bore Clearance Tin Coated MRC: 0.020 mm MP: 20.25 mm | TEIKIN NO. 43218 REFERENCE NO. MD119671 (R) MD152563 (L) 23410-35104/14/24 23410-35134/44/54 | | TEIKIN NO. P 39104 | | | | 64 |

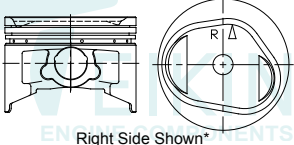
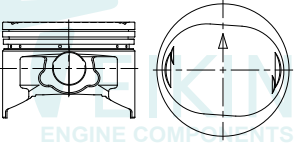
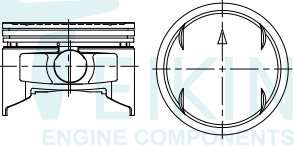
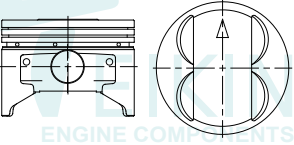

| ENGINE TYPE | PISTON | PISTON RING | PISTON PIN | PIN BUSHING | LINER | | LINER KIT SET |
|---|--|-------------------------------|--------------------------------|-------------|---------|-----------|---------------|
| | | | | | FLANGED | NO FLANGE | |
| 6G72 NEW 2972 cc 6 cyl. F.I., SOHC V6, 12 V MONTERO 1994, 3000GT 1994-99 HYUNDAI 3000 CC | \emptyset 91.10 -3.1 CD 32.2 TL 66.2 | 1 - 1.2 1 - 1.5 1 - 3.0 | \emptyset 22.000 TL 64.00 | | | | TEIKIN NO. |
|  <p>Right Side Shown*</p> | TEIKIN NO. 43220 | TEIKIN NO. P 43220 | | | | | |
| Surface Treatment Bore Clearance Tin Coated MRC: 0.020 mm MP: 16.00 mm | REFERENCE NO. MD197808 (R) MD197814 (L) 23410-35214 (R) 23410-35244 (L) | | | | | | |
| | | | | | | 65 | |
| 6G72H 2972 cc 6 cyl. DIAMANTE 1992-96 F.I., SOHC, 12 V HYUNDAI FBM | \emptyset 91.10 -0.3 CD 31.9 TL 65.9 | 1 - 1.2 1 - 1.5 1 - 3.0 | \emptyset 22.000 TL 64.00 | | | | TEIKIN NO. |
|  | TEIKIN NO. 43249 | TEIKIN NO. P 43220 | | | | | |
| Surface Treatment Bore Clearance Tin Coated MRC: 0.030 mm MP: 20.00 mm | REFERENCE NO. MD307944 MD194548 23410-35650 23410-35660/70 | | | | | | |
| | | | | | | 66 | |
| 6G72-II 2972 cc 6 cyl. MONTERO SPORT 2001-02 GALANT, ECLIPSE 2000-02 F.I., SOHC 24V | \emptyset 91.10 -1.3 CD 30.2 TL 64.2 | 1 - 1.2 1 - 1.5 1 - 3.0 | \emptyset 22.000 TL 64.00 | | | | TEIKIN NO. |
|  | TEIKIN NO. 43278 | TEIKIN NO. P 43220 | | | | | |
| Surface Treatment Bore Clearance None MRC: 0.030 mm MP: 19.50 mm | REFERENCE NO. MD367089 | | | | | | |
| | | | | | | 67 | |
| 6G72-III 2972 cc 6 cyl. | \emptyset 91.10 +0.5 CD 32.0 TL 66.5 | 1 - 1.2 1 - 1.5 1 - 3.0 | \emptyset 22.000 TL 64.00 | | | | TEIKIN NO. |
|  | TEIKIN NO. 43669 | TEIKIN NO. P 43669 | | | | | |
| Surface Treatment Bore Clearance Tin Coated MRC: 0.030 mm MP: 15.00 mm | REFERENCE NO. MD307958 MD158317 | | | | | | |
| | | | | | | 68 | |







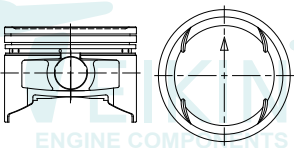
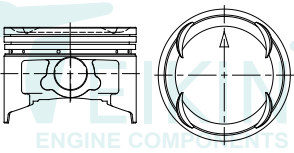
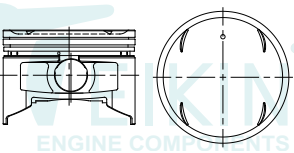
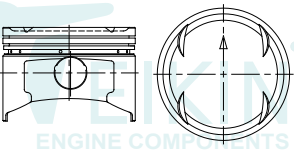

SUITABLE FOR

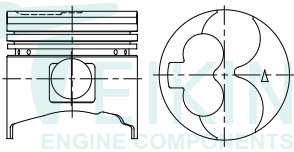

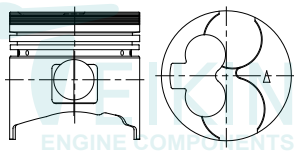

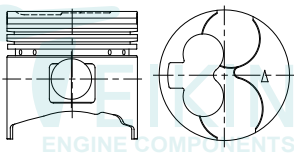

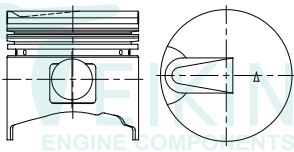

MITSUBISHI

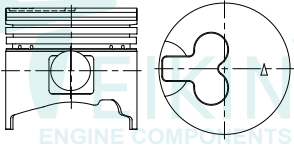
GASOLINE

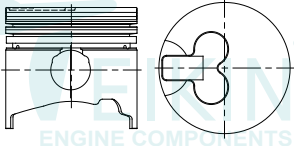

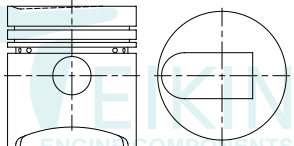
| ENGINE TYPE | PISTON | PISTON RING | PISTON PIN | PIN BUSHING | LINER | | LINER KIT SET |
|--|--|-------------------------------|---|-------------|---------|-----------|---------------|
| | | | | | FLANGED | NO FLANGE | |
| 6G72-IV 2972 cc 6 cyl.  Surface Treatment: Tin Coated Bore Clearance: MRC: 0.030 mm, MP: 20.00 mm | Ø 91.10 -2.5 CD 31.8 TL 65.7 | 1 - 1.2 1 - 1.5 1 - 3.0 | Ø 22.000 TL 64.00 | | | | TEIKIN NO. |
| | TEIKIN NO. 43667 (43665) | | TEIKIN NO. P 43220 | | | | |
| | REFERENCE NO. MD318501 | | | | | | |
| | | | | | | | 69 |
| 6G72-T 2972 cc 6 cyl. 3000GT TURBO F.I., DOHC, 24 V 1991-99  Surface Treatment: Tin Coated Bore Clearance: MRC: 0.020 mm, MP: 15.00 mm | Ø 91.10 -3.4 CD 31.9 TL 65.9 | 1 - 1.2 1 - 1.5 1 - 3.0 | Ø 22.000 TL 64.00 | | | | TEIKIN NO. |
| | TEIKIN NO. 43235 | | TEIKIN NO. P 43220 | | | | |
| | REFERENCE NO. MD307972 | | | | | | |
| | | | | | | | 70 |
| 6G72-V 2972 cc 6 cyl.  Surface Treatment: Tin Coated Bore Clearance: MRC: 0.030 mm, MP: 19.50 mm | Ø 91.10 -2.7 CD 31.2 TL 65.2 | 1 - 1.2 1 - 1.5 1 - 3.0 | Ø 22.000 TL 64.00 | | | | TEIKIN NO. |
| | TEIKIN NO. 43294 | | TEIKIN NO. P 43220 | | | | |
| | REFERENCE NO. MD367101 | | | | | | |
| | | | | | | | 71 |
| 6G74 3496 cc 6 cyl. MONTERO 1994-96 F.I., DOHC V6, 24V HYUNDAI 3500 CC  Surface Treatment: Tin Coated Bore Clearance: MRC: 0.030 mm, MP: 20.00 mm | Ø 93.00 -2.8 CD 32.0 TL 65.9 | 2 - 1.5 1 - 3.0 | Ø 22.000 TL 64.00  | | | | TEIKIN NO. |
| | TEIKIN NO. 43247 | | TEIKIN NO. P 43220 | | | | |
| | REFERENCE NO. MD308276 MD189498 23410-35700 23410-35710/20 | | | | | | |
| | | | | | | | 72 |

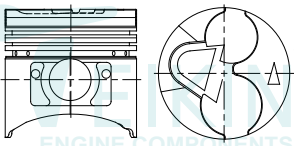
| ENGINE TYPE | PISTON | PISTON RING | PISTON PIN | PIN BUSHING | LINER | | LINER KIT SET |
|---|---|---|---|------------------------------|---|---------------|---|
| | | | | | FLANGED | NO FLANGE | |
| 4D65 1795 cc 4 cyl.  | \emptyset 80.60 -2.30 CD 41.9 TL 78.9 | 2 - 2.0 HK 1 - 4.0 | \emptyset 25.000 TL 68.00  | | TL 150.0 OD 84.6 FT 4.0 FD 90.5 | 146.0 84.6 | TEIKIN NO. LKSF 43264 LKSX 43264 LKSF 43264A LKSX 43264A |
| | TEIKIN NO. 43264 43264A (43650) | TEIKIN NO. R 43229 | TEIKIN NO. P 42167 | TEIKIN NO. B 43229 | TEIKIN NO. LSF 43229 LSX 43229 | | |
| | REFERENCE NO. | REFERENCE NO. MD071206 MD078209/309 MD127017/22 MD136692 | REFERENCE NO. MD060467 | REFERENCE NO. | | | |
| | Surface Treatment Bore Clearance Tin Coated MRC: 0.030 mm MP: 19.50 mm | | | | | | |
| 76 | | | | | | | |
| 4D65-II 1800 cc 4 cyl.  | \emptyset 80.60 -2.3 CD 41.9 TL 78.9 | 1 - 2.0 HK 1 - 2.0 1 - 4.0 | \emptyset 25.000 TL 68.00  | | TL 150.0 OD 84.6 FT 4.0 FD 90.5 | 146.0 84.6 | TEIKIN NO. LKSF 43286 LKSX 43286 LKSF 43286A LKSX 43286A |
| | TEIKIN NO. 43286 43286A | TEIKIN NO. R 43229 | TEIKIN NO. P 42167 | TEIKIN NO. B 43229 | TEIKIN NO. LSF 43229 LSX 43229 | | |
| | REFERENCE NO. MD061985 | REFERENCE NO. MD071206 MD078209/309 MD127017/22 MD136692 | REFERENCE NO. MD060467 | REFERENCE NO. | | | |
| | Surface Treatment Bore Clearance Tin Coated MRC: 0.030 mm MP: 19.50 mm | | | | | | |
| 77 | | | | | | | |
| 4D65T 1795 cc 4 cyl.  | \emptyset 80.60 -2.1 CD 41.7 TL 78.7 | 2 - 2.0 HK 1 - 4.0 | \emptyset 25.000 TL 68.00  | | TL 150.0 OD 84.6 FT 4.0 FD 90.5 | 146.0 84.6 | TEIKIN NO. LKSF 43229 LKSX 43229 LKSF 43229A LKSX 43229A |
| | TEIKIN NO. 43229 43229A | TEIKIN NO. R43229 | TEIKIN NO. P 42167 | TEIKIN NO. B 43229 | TEIKIN NO. LSF 43229 LSX 43229 | | |
| | REFERENCE NO. MD072264 | REFERENCE NO. MD071206 MD078209/309 MD127017/22 MD136692 | REFERENCE NO. MD060467 | REFERENCE NO. | | | |
| | Surface Treatment Bore Clearance Tin Coated MRC: 0.030 mm MP: 19.50 mm | | | | | | |
| 78 | | | | | | | |
| 4D65T OLD 1795 cc 4 cyl.  | \emptyset 80.60 -3.5 CD 41.8 TL 78.8 | 2 - 2.0 HK 1 - 4.0 | \emptyset 25.000 TL 68.00  | | TL 150.0 OD 84.6 FT 4.0 FD 90.5 | 146.0 84.6 | TEIKIN NO. LKSF 43241 LKSX 43241 LKSF 43241A LKSX 43241A |
| | TEIKIN NO. 43241 43241A | TEIKIN NO. R 43229 | TEIKIN NO. P 42167 | TEIKIN NO. B 43229 | TEIKIN NO. LSF 43229 LSX 43229 | | |
| | REFERENCE NO. MD131615 MD131612 | REFERENCE NO. MD071206 MD078209/309 MD127017/22 MD136692 | REFERENCE NO. MD060467 | REFERENCE NO. | | | |
| | Surface Treatment Bore Clearance Tin Coated MRC: 0.030 mm MP: 19.50 mm | | | | | | |
| 79 | | | | | | | |

| ENGINE TYPE | PISTON | PISTON RING | PISTON PIN | PIN BUSHING | LINER | | | LINER KIT SET |
|--|---|-------------------------------------|---|----------------------------------|--|---------------|---|---------------|
| | | | | | FLANGED | NO FLANGE | | |
| 4D68 1998 cc 4 cyl.  | \emptyset 82.70 -1.9 CD 39.4 TL 76.3 | 1 - 2.0 HK 1 - 2.0 1 - 3.0 | \emptyset 25.000 TL 67.00  | | TL 170.0 OD 86.7 FT 5.0 FD 90.7 | 165.0 86.7 | TEIKIN NO. LKSF 43613 LKSX 43613 LKFX 43613 LKSF 43613A LKSX 43613A LKFX 43613A | |
| | TEIKIN NO. 43613 43613A (43240) | TEIKIN NO. R 43613 | TEIKIN NO. P 39157 | TEIKIN NO. B 43229 | TEIKIN NO. LSF 43612 LSX 43612 LFX 43612 | | | |
| | REFERENCE NO. MD194163 MD194168 | REFERENCE NO. MD197162 | | REFERENCE NO. MD060467 | REFERENCE NO. | | | |
| | Surface Treatment Bore Clearance Tin Coated MRC: 0.060 mm MP: 20.00 mm | | | | | | | |
| 4D68T 1998 cc 4 cyl.  | \emptyset 82.70 -1.5 CD 39.3 TL 76.3 | 2 - 2.0 HK 1 - 3.0 | \emptyset 25.000 TL 66.00  | | TL 170.0 OD 86.7 FT 5.0 FD 90.7 | 165.0 86.7 | TEIKIN NO. LKSF 43612 LKSX 43612 LKFX 43612 LKSF 43612AG LKSX 43612AG LKFX 43612AG | |
| | TEIKIN NO. 43612 43612AG (43243) | TEIKIN NO. R 43612 | TEIKIN NO. P 43612 | TEIKIN NO. B 43229 | TEIKIN NO. LSF 43612 LSX 43612 LFX 43612 | | | |
| | REFERENCE NO. MD194157 | REFERENCE NO. MD197187 | | REFERENCE NO. MD060467 | REFERENCE NO. | | | |
| | Surface Treatment Bore Clearance Tin Coated MRC: 0.030 mm MP: 10.00 mm | | | | | | | |
| 4DQ5 2084 cc 4 cyl.  | \emptyset 84.00 -1.95 CD 45.3 TL 92.3 | 1 - 2.5 1 - 2.0 1 - 4.0 | \emptyset 25.000 TL 70.00  | | TL OD | 163.0 88.0 | TEIKIN NO. LKSX 43687 | |
| | TEIKIN NO. 43687 | TEIKIN NO. R 43687 | TEIKIN NO. P G0118 | TEIKIN NO. B 43687 | TEIKIN NO. LSX 43687 | | | |
| | REFERENCE NO. 30617-57105 | REFERENCE NO. 30617-51011 | | REFERENCE NO. | REFERENCE NO. 30607-50301 | | | |
| | Surface Treatment Bore Clearance Tin Coated MRC: 0.110 mm MP: 25.00 mm | | | | | | | |
| 4D55 / 4D56 2346 cc 4 cyl. L 300 D HYUNDAI D4BX OLD  | \emptyset 91.10 -2.8 CD 48.7 TL 88.8 | 1 - 2.5 1 - 2.0 1 - 4.0 | \emptyset 29.000 TL 75.00  | | TL 165.0 OD 94.2 FT 4.0 FD 98.1 | 164.5 94.2 | TEIKIN NO. LKSF 43171 LKSX 43171 LKFX 43171 LKSF 43171A LKSX 43171A LKFX 43171A | |
| | TEIKIN NO. 43171 43171A | TEIKIN NO. R 43171 | TEIKIN NO. P 43171 | TEIKIN NO. B 43171 | TEIKIN NO. LSF 43171 LSX 43171 LFX 43171 | | | |
| | REFERENCE NO. MD050021 MD103318 23410-42000 23410-42010/20 | REFERENCE NO. MD050395 | | REFERENCE NO. MD050009 | REFERENCE NO. MD050430 MD103648 MD168963 | | | |
| | Surface Treatment Bore Clearance Tin Coated MRC: 0.030 mm MP: 19.00 mm | | | | | | | |



80

81

82









83

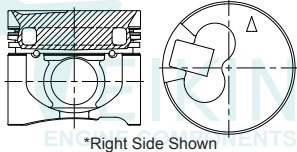

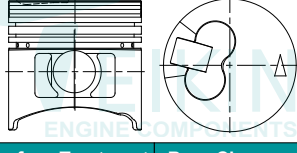

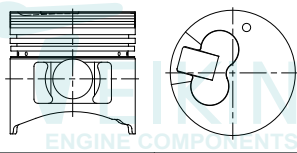

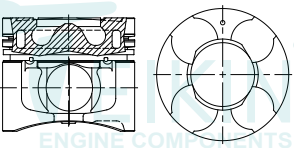

SUITABLE FOR

MITSUBISHI

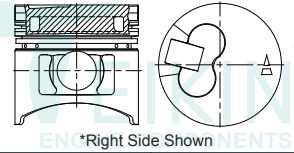

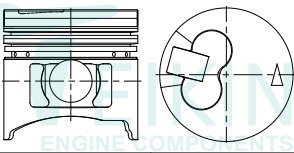

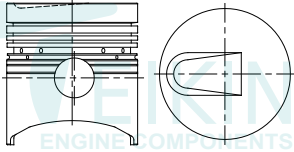



DIESEL

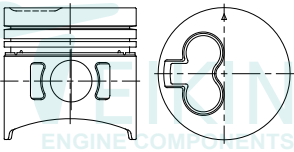

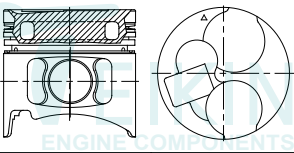
| ENGINE TYPE | PISTON | PISTON RING | PISTON PIN | PIN BUSHING | LINER | | | LINER KIT SET |
|---|---|--|---|----------------------------------|--|---------------|--|---------------|
| | | | | | FLANGED | NO FLANGE | | |
| 4D55T/4D56T-II 2476 cc 4 cyl.  *Right Side Shown Surface Treatment Bore Clearance Tin Coated MRC: 0.020 mm Anodized Crown MP: 10.00 mm | \emptyset 91.10 -2.6 CD 48.7 TL 78.7 | 1 - 2.5 HK 1 - 2.0 HK 1 - 4.0 | \emptyset 32.000 TL 75.00  | | TL 165.0 OD 94.2 FT 4.0 FD 98.1 | 164.5 94.2 | TEIKIN NO. LKSF 43672AG LKXS 43672AG LKFX 43672AG | |
| | TEIKIN NO. 43672AG | TEIKIN NO. R 43173 | TEIKIN NO. P 43672 | TEIKIN NO. B 43672 | TEIKIN NO. LSF 43171 LSX 43171 LFX 43171 | | | |
| | REFERENCE NO. MR984128/30 (R/L) | REFERENCE NO. 1110A561 1110A562/3 MD050390 MD103391 | | REFERENCE NO. | REFERENCE NO. MD050430 MD103648 MD168963 | | | |
| | | | | | | | | 84 |
| 4D56 LATE 2476 cc 4 cyl.  Surface Treatment Bore Clearance Tin Coated MRC: 0.030 mm Anodized Crown MP: 19.00 mm | \emptyset 91.10 -2.7 CD 48.7 TL 88.7 | 1 - 2.5 1 - 2.0 1 - 4.0 | \emptyset 29.000 TL 75.00  | | TL 165.0 OD 94.2 FT 4.0 FD 98.1 | 164.5 94.2 | TEIKIN NO. LKSF 43291 LKXS 43291 LKFX 43291 LKSF 43291A LKXS 43291A LKFX 43291A | |
| | TEIKIN NO. 43291 43291A | TEIKIN NO. R 43171 | TEIKIN NO. P 43171 | TEIKIN NO. B 43171 | TEIKIN NO. LSF 43171 LSX 43171 LFX 43171 | | | |
| | REFERENCE NO. MD304838 | REFERENCE NO. MD050395 | | REFERENCE NO. MD050009 | REFERENCE NO. MD050430 MD103648 MD168963 | | | |
| | | | | | | | | 85 |
| 4D56-II 2476 cc 4 cyl.  Surface Treatment Bore Clearance Tin Coated MRC: 0.030 mm Anodized Crown MP: 19.00 mm | \emptyset 91.10 -2.6 CD 48.7 TL 88.7 | 1 - 2.5 1 - 2.0 1 - 4.0 | \emptyset 29.000 TL 75.00  | | | | TEIKIN NO. | |
| | TEIKIN NO. 43285 | TEIKIN NO. R 43171 | TEIKIN NO. P 43171 | | | | | |
| | REFERENCE NO. MD304835 | REFERENCE NO. MD050395 | | | | | | |
| | | | | | | | | 86 |
| 4D56T 2346 cc 4 cyl. L 300 D NEW HYUNDAI TC (D4BF-T) 1980  Surface Treatment Bore Clearance Tin Coated MRC: 0.030 mm Anodized Crown MP: 19.00 mm | \emptyset 91.10 -2.8 CD 48.7 TL 88.8 | 1 - 2.5 HK 1 - 2.0 HK 1 - 4.0 | \emptyset 29.000 TL 75.00  | | TL 165.0 OD 94.2 FT 4.0 FD 98.1 | 164.5 94.2 | TEIKIN NO. LKSF 43173 LKXS 43173 LKFX 43173 LKSF 43173A LKXS 43173A LKFX 43173A | |
| | TEIKIN NO. 43173 43173A | TEIKIN NO. R 43173 | TEIKIN NO. P 43171 | TEIKIN NO. B 43171 | TEIKIN NO. LSF 43171 LSX 43171 LFX 43171 | | | |
| | REFERENCE NO. MD103308 MD050011 23410-42850 23410-42860/70 | REFERENCE NO. 1110A561 1110A562/3 MD050390 MD103391 | | REFERENCE NO. MD050009 | REFERENCE NO. MD050430 MD103648 MD168963 | | | |
| | | | | | | | | 87 |

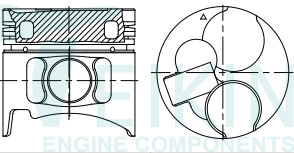
| ENGINE TYPE | PISTON | PISTON RING | PISTON PIN | PIN BUSHING | LINER | | | LINER KIT SET |
|--|--|--|---|--|--|---------------|--|---------------|
| | | | | | FLANGED | NO FLANGE | | |
| 4D56T CDRI 2477 cc 4 cyl.  | \varnothing 91.10 -19.0 CD 48.2 TL 78.2 | 1 - 2.5 HK 1 - 2.0 HK 1 - 4.0 | \varnothing 32.000 TL 75.00  | | TL 165.0 OD 94.2 FT 4.0 FD 98.1 | 164.5 94.2 | TEIKIN NO. LKFX 43678AG LKSF 43678AG LKSX 43678AG | |
| Surface Treatment Bore Clearance Anodized Crown Moly Skirt MRC: 0.030 mm MP: 10.00 mm | TEIKIN NO. 43678AG | TEIKIN NO. R 43173 | TEIKIN NO. P 43672 | TEIKIN NO. B 43672 | TEIKIN NO. LFX 43171 LSF 43171 LSX 43171 | | | |
| | REFERENCE NO. 1110A593 (R/L) 1110A594 1110A595 1110A596 | REFERENCE NO. 1110A561 1110A562/3 MD050390 MD103391 | | REFERENCE NO. | REFERENCE NO. MD050430 MD103648 MD050243 | | | |
| | | | | | | | 88 | |
| 4D56-T LATE 2476 cc HYUNDAI D4BH TCI 4 cyl.  | \varnothing 91.10 -2.7 CD 48.7 TL 88.7 | 1 - 2.5 HK 1 - 2.0 HK 1 - 4.0 | \varnothing 29.000 TL 75.00  | | TL 165.0 OD 94.2 FT 4.0 FD 98.1 | 164.5 94.2 | TEIKIN NO. LKSF 43242AG LKSX 43242AG LKFX 43242AG | |
| Surface Treatment Bore Clearance Tin Coated MRC: 0.030 mm MP: 18.90 mm | TEIKIN NO. 43242AG | TEIKIN NO. R 43173 | TEIKIN NO. P 43171 | TEIKIN NO. B 43171 | TEIKIN NO. LSF 43171 LSX 43171 LFX 43171 | | | |
| | REFERENCE NO. MD304853 (R) MD304859 (L) 23410-42170 (R) 23430-42170 (L) | REFERENCE NO. 1110A561 1110A562/3 MD050390 MD103391 | | REFERENCE NO. MD050009 | REFERENCE NO. MD050430 MD103648 MD050243 | | | |
| | | | | | | | 89 | |
| 4D56-T LATE-II 2476 cc 4 cyl.  | \varnothing 91.10 -2.7 CD 48.7 TL 88.7 | 1 - 2.5 HK 1 - 2.0 HK 1 - 4.0 | \varnothing 29.000 TL 75.00  | | TL 165.0 OD 94.2 FT 4.0 FD 98.1 | 164.5 94.2 | TEIKIN NO. LKSF 43661 LKSX 43661 LKFX 43661 LKSF 43661A LKSX 43661A LKFX 43661A | |
| Surface Treatment Bore Clearance Tin Coated MRC: 0.030 mm MP: 19.00 mm | TEIKIN NO. 43661 43661A | TEIKIN NO. R 43173 | TEIKIN NO. P 43171 | TEIKIN NO. B 43171 | TEIKIN NO. LSF 43171 LSX 43171 LFX 43171 | | | |
| | REFERENCE NO. MD304850 MD304847 | REFERENCE NO. 1110A561 1110A562/3 MD050390 MD103391 | | REFERENCE NO. MD050009 | REFERENCE NO. MD050430 MD103648 MD050243 | | | |
| | | | | | | | 90 | |
| 4DR5 2659 cc T-210 1971 4 cyl.  | \varnothing 92.00 -3.8 CD 52.5 TL 99.7 | 1 - 2.5 HK 2 - 2.0 1 - 4.5 | \varnothing 28.000 TL 76.80  | | TL OD | 176.0 95.0 | TEIKIN NO. LKSX 43157 | |
| Surface Treatment Bore Clearance Tin Coated MRC: 0.080 mm MP: 25.00 mm | TEIKIN NO. 43157 | TEIKIN NO. R 43157 | TEIKIN NO. P 43157 | TEIKIN NO. B 43157 | TEIKIN NO. LSX 43157 | | | |
| | REFERENCE NO. 31617-00104 31617-00106 | REFERENCE NO. 31617-02012/3 31617-05102/3 ME999073 | | REFERENCE NO. 31619-00700 31619-00792 | REFERENCE NO. 31607-02202 | | | |
| | | | | | | | 91 | |

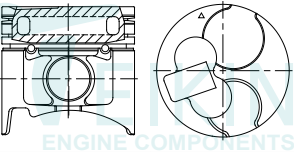

| ENGINE TYPE | PISTON | PISTON RING | PISTON PIN | PIN BUSHING | LINER | | | LINER KIT SET |
|---|--|--|---|----------------------------------|--|-----------|-------|--|
| | | | | | FLANGED | NO FLANGE | | |
| 4DR7 2835 cc 4 cyl.  Surface Treatment Bore Clearance Tin Coated MRC: 0.060 mm Anodized Crown MP: 20.50 mm | \emptyset 95.00 -2.2 CD 52.6 TL 94.6 | 1 - 2.7 FK 1 - 2.0 1 - 4.0 | \emptyset 30.000 TL 78.00  | | TL | | 180.0 | TEIKIN NO. LKSX 43610 LKSX 43610A |
| | TEIKIN NO. 43610 43610A (43239) | TEIKIN NO. R 43232 | TEIKIN NO. P 43232 | TEIKIN NO. B 43232 | TEIKIN NO. LSX 43610 | | | |
| | REFERENCE NO. ME021861 | REFERENCE NO. ME201522 ME202380 ME202950 ME997256/894 | | REFERENCE NO. ME201016 | REFERENCE NO. ME997798 | | | |
| | | | | | | | | |
| 4M40 2835 cc 4 cyl.  Surface Treatment Bore Clearance Tin Coated MRC: 0.050 mm Anodized Crown MP: 32.00 mm | \emptyset 95.00 -3.0 CD 51.7 TL 91.7 | 1 - 2.3 FK 1 - 2.0 1 - 4.0 | \emptyset 30.000 TL 78.00  | | TL | | 186.0 | TEIKIN NO. LKSF 43673A LKSX 43673A LKFX 43673A |
| | TEIKIN NO. 43673A | TEIKIN NO. R 43232 | TEIKIN NO. P 43232 | TEIKIN NO. B 43232 | TEIKIN NO. LSF 43232 LSX 43232 LFX 43232 | | | |
| | REFERENCE NO. ME200680/1/2 ME201780/1/2 | REFERENCE NO. ME201522 ME202380 ME202950 ME997256/894 | | REFERENCE NO. ME201016 | REFERENCE NO. MD168963 ME200685 ME99919 | | | |
| | | | | | | | | |
| 4M40-T 2835 cc 4 cyl.  Surface Treatment Bore Clearance Tin Coated MRC: 0.040 mm Anodized Crown MP: 19.00 mm | \emptyset 95.00 -3.0 CD 51.6 TL 91.6 | 1 - 2.3 FK 1 - 2.0 1 - 4.0 | \emptyset 30.000 TL 78.00  | | TL | | 186.0 | TEIKIN NO. LKSF 43232 LKSX 43232 LKFX 43232 LKSF 43232A LKSX 43232A LKFX 43232A LKSF 43232AG LKSX 43232AG LKFX 43232AG |
| | TEIKIN NO. 43232 43232A 43232AG | TEIKIN NO. R 43232 | TEIKIN NO. P 43232 | TEIKIN NO. B 43232 | TEIKIN NO. LSF 43232 LSX 43232 LFX 43232 | | | |
| | REFERENCE NO. ME200689 | REFERENCE NO. ME201522 ME202380 ME202950 ME997256/894 | | REFERENCE NO. ME201016 | REFERENCE NO. MD168963 ME200685 ME99919 | | | |
| | | | | | | | | |
| 4M40-T-II 2835 cc 4 cyl.  Surface Treatment Bore Clearance Tin Coated MRC: 0.060 mm Anodized Crown MP: 18.50 mm | \emptyset 95.00 -3.0 CD 51.6 TL 91.6 | 1 - 2.3 FK 1 - 2.0 1 - 3.0 | \emptyset 30.000 TL 78.00  | | TL | | 186.0 | TEIKIN NO. LKSF 43670AG LKSX 43670AG LKFX 43670AG |
| | TEIKIN NO. 43670AG | TEIKIN NO. R 43670 | TEIKIN NO. P 43232 | TEIKIN NO. B 43232 | TEIKIN NO. LSF 43232 LSX 43232 LFX 43232 | | | |
| | REFERENCE NO. ME203223 ME203224 ME203225 | REFERENCE NO. ME190317 ME202148 ME202848 | | REFERENCE NO. ME201016 | REFERENCE NO. MD168963 ME200685 ME99919 | | | |
| | | | | | | | | |









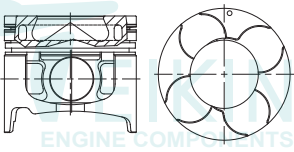

96

97

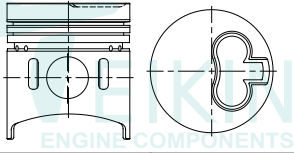

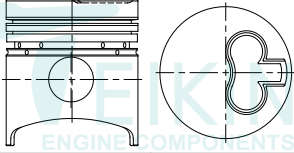

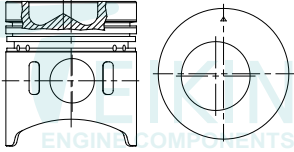

98



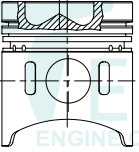

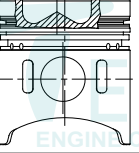

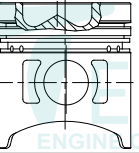

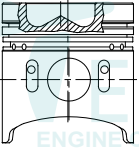
99

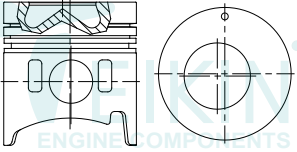
| ENGINE TYPE | PISTON | PISTON RING | PISTON PIN | PIN BUSHING | LINER | | | LINER KIT SET |
|--|---|--|------------------------------|--|---|---------------------------------------|----------------|---|
| | | | | | FLANGED | NO FLANGE | | |
| 4M42-0AT 2977 cc 4 cyl. | Ø 95.00 -18.1 CD 47.0 TL 87.0 | 1 - 2.3 FK 1 - 2.0 1 - 3.0 | Ø 32.000 TL 80.00 | | TL OD FT FD | 186.0 99.0 2.5 104.6 | 186.0 99.0 | TEIKIN NO. LKSF 43681AG LKSX 43681AG LKFX 43681AG |
| Surface Treatment Tin Coated Bore Clearance MRC: 0.090 mm MP: 20.00 mm | TEIKIN NO. 43681AG REFERENCE NO. ME190903 ME190906 | TEIKIN NO. R 43670 REFERENCE NO. ME190317 ME202148 ME202848 | TEIKIN NO. P G1106 | TEIKIN NO. B 43663 REFERENCE NO. ME203868 | TEIKIN NO. LSF 43232 LSX 43232 LFX 43232 REFERENCE NO. MD168963 ME200685 ME99919 | 100 | | |
| S4E2 2960 cc 4 cyl. | Ø 98.00 -3.2 CD 51.5 TL 98.5 | 1 - 3.0 HK 1 - 2.0 1 - 5.0 | Ø 28.000 TL 77.00 | | TL OD FT FD | 170.0 101.0 4.0 130.0 | 168.5 102.0 | TEIKIN NO. LKSF 43688 LKSX 43688 |
| Surface Treatment Tin Coated Bore Clearance MRC: 0.080 mm MP: 27.00 mm | TEIKIN NO. 43688 REFERENCE NO. 34417-54100 | TEIKIN NO. R 43688 REFERENCE NO. 34417-09012 | TEIKIN NO. P 43609 | TEIKIN NO. B 43688 REFERENCE NO. | TEIKIN NO. LSF 43688 LSX 43688 REFERENCE NO. 34407-00500 34407-05400 | 101 | | |
| 6DS7 FUSO T-653 5430 cc 6 cyl. | Ø 98.00 -9.4 CD 60.7 TL 105.2 | 1 - 3.0 HK 1 - 2.0 1 - 5.0 | Ø 32.000 TL 82.00 | | TL OD FT FD | 201.0 110.0 10.0 +0.9 117.0 | | TEIKIN NO. LKFF 43115 |
| Surface Treatment Tin Coated Bore Clearance MRC: 0.100 mm MP: 16.50 mm | TEIKIN NO. 43115 REFERENCE NO. ME024402 ME023274 ME024407 | TEIKIN NO. R 43115 REFERENCE NO. ME021861 ME023333 ME024409 | TEIKIN NO. P 43115 | TEIKIN NO. B 43115 REFERENCE NO. ME020448 ME020449 | TEIKIN NO. LFF 43115 REFERENCE NO. ME021843 | 102 | | |
| 6DS7 NEW FUSO T-653 5430 cc 6 cyl. | Ø 98.00 -9.4 CD 60.7 TL 105.2 | 1 - 3.0 HK 1 - 2.0 1 - 5.0 | Ø 32.000 TL 82.00 | | TL OD FT FD | 206.0 110.0 10.0 +1.15 117.0 | | TEIKIN NO. LKFF 43115N |
| Surface Treatment Tin Coated Bore Clearance MRC: 0.100 mm MP: 16.50 mm | TEIKIN NO. 43115N REFERENCE NO. ME024402 ME023274 ME024407 | TEIKIN NO. R 43115 REFERENCE NO. ME021861 ME023333 ME024409 | TEIKIN NO. P 43115 | TEIKIN NO. B 43115 REFERENCE NO. ME020448 ME020449 | TEIKIN NO. LFF 43115N REFERENCE NO. ME029081 ME029187 | 103 | | |

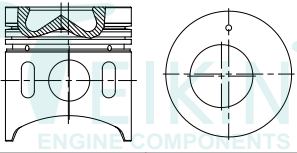
| ENGINE TYPE | PISTON | PISTON RING | PISTON PIN | PIN BUSHING | LINER | | | LINER KIT SET |
|---|---|----------------------------------|---|--|--|----------------------|---|---------------|
| | | | | | FLANGED | NO FLANGE | | |
| 4M41-T 3200 cc 4 cyl.  Surface Treatment Bore Clearance Anodized Crown Moly Skirt MRC: 0.060 mm MP: 18.00 mm | \varnothing 98.50 -20.7 CD 47.0 TL 87.0 | 1 - 2.5 FK 1 - 1.5 1 - 3.0 | \varnothing 32.000 TL 78.00  | | TL 170.5 OD 102.5 FT 4.0 FD 105.5 | 170.0 102.5 | TEIKIN NO. LKSF 43663AG LKXS 43663AG 104 | |
| | TEIKIN NO. | TEIKIN NO. | TEIKIN NO. | TEIKIN NO. | TEIKIN NO. | | | |
| | 43663AG | R 43663 | P 52107 | B43663 | LSF 43663 LSX 43663 | | | |
| | REFERENCE NO. | REFERENCE NO. | REFERENCE NO. | REFERENCE NO. | REFERENCE NO. | | | |
| | ME191469 ME191470 | ME203533 | | ME203868 | | | | |
| 4D30 3300 cc 4 cyl. CANTER 2T, 3T FE 83  Surface Treatment Bore Clearance None MRC: 0.050 mm MP: 26.00 mm | \varnothing 100.00 -2.8 CD 60.4 TL 110.4 | 1 - 3.0 HK 1 - 2.0 1 - 5.0 | \varnothing 34.000 TL 83.50  | | TL 197.0 OD 104.0 FT 5.0 FD 109.0 | 197.0 104.0 | TEIKIN NO. LKSF 43166 LKXS 43166 LKSF 43166A LKXS 43166A 105 | |
| | TEIKIN NO. | TEIKIN NO. | TEIKIN NO. | TEIKIN NO. | TEIKIN NO. | | | |
| | 43166 43166A | R 43166 | P 39138 | B 43663 | LSF 43166 LSX 43166 | | | |
| | REFERENCE NO. | REFERENCE NO. | REFERENCE NO. | REFERENCE NO. | REFERENCE NO. | | | |
| | ME012100 ME012001-3 ME012115 | ME012010 ME012070 | | ME012203 ME012249 ME012255 ME012257 | | ME011513 | | |
| 4D30 OLD 3300 cc 4 cyl. FE 1979  Surface Treatment Bore Clearance None MRC: 0.100 mm MP: 26.70 mm | \varnothing 100.00 -2.8 CD 60.5 TL 110.5 | 1 - 3.0 HK 1 - 2.0 1 - 5.0 | \varnothing 34.000 TL 83.50  | | TL 197.0 OD 104.0 FT 5.0 FD 109.0 | 197.0 104.0 | TEIKIN NO. LKSF 43164 LKXS 43164 LKSF 43164A LKXS 43164A 106 | |
| | TEIKIN NO. | TEIKIN NO. | TEIKIN NO. | TEIKIN NO. | TEIKIN NO. | | | |
| | 43164 43164A | R 43166 | P 39138 | B 43683 | LSF 43166 LSX 43166 | | | |
| | REFERENCE NO. | REFERENCE NO. | REFERENCE NO. | REFERENCE NO. | REFERENCE NO. | | | |
| | ME012051 ME012190 | ME012010 ME012070 | | ME012203 ME012249 ME012255 ME012257 | | ME011513 | | |
| 4D31 / 4D31T 3300 cc 4 cyl. PS 100  Surface Treatment Bore Clearance None MRC: 0.070 mm MP: 26.80 mm | \varnothing 100.00 -18.3 CD 60.7 TL 110.7 | 1 - 3.0 HK 1 - 2.0 1 - 5.0 | \varnothing 34.000 TL 83.50  | | TL 191.0 OD 104.0 FT 5.0 FD 109.0 | 191.0 104.0 | TEIKIN NO. LKSF 43168 LKXS 43168 LKFX 43168 LKSF 43168A LKXS 43168A LKFX 43168A 107 | |
| | TEIKIN NO. | TEIKIN NO. | TEIKIN NO. | TEIKIN NO. | TEIKIN NO. | | | |
| | 43168 43168A | R 43166 | P 39138 | B 43683 | LSF 43168 LSX 43168 LFX 43168 | | | |
| | REFERENCE NO. | REFERENCE NO. | REFERENCE NO. | REFERENCE NO. | REFERENCE NO. | | | |
| | ME012131 ME012145 ME012160 | ME012010 ME012070 | | ME012203 ME012249 ME012255 ME012257 | | ME011523 ME011604 | | |

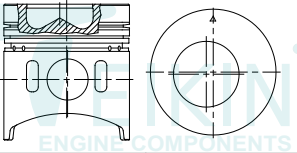

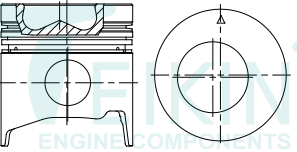
| ENGINE TYPE | PISTON | PISTON RING | PISTON PIN | PIN BUSHING | LINER | | | LINER KIT SET |
|---|---|--|---|--|--|----------------|--|---------------|
| | | | | | FLANGED | NO FLANGE | | |
| 6D31 / 6D31T 4948 cc 6 cyl. | \emptyset 100.00 -18.3 CD 60.7 TL 110.7 | 1 - 3.0 HK 1 - 2.0 1 - 5.0 | \emptyset 34.000 TL 83.50  | | TL 191.0 OD 104.0 FT 5.0 FD 109.0 | 191.5 104.0 | TEIKIN NO. LKSF 43168-6 LKSX 43168-6 | |
|  Surface Treatment None Bore Clearance MRC: 0.070 mm MP: 26.80 mm | TEIKIN NO. 43168-6 | TEIKIN NO. R 43168-6 | TEIKIN NO. P 39138 | TEIKIN NO. B 43168-6 | TEIKIN NO. LSF 43168-6 LSX 43168-6 | | 108 | |
| | REFERENCE NO. ME012131 ME012145 ME012160 | REFERENCE NO. ME999717 | REFERENCE NO. ME012257 | REFERENCE NO. ME011626 | | | | |
| 4D31 T 3298 cc 4 cyl. | \emptyset 100.00 -18.0 CD 60.7 TL 110.7 | 1 - 3.0 HK 1 - 2.0 1 - 5.0 | \emptyset 34.000 TL 84.00  | | TL 191.0 OD 104.0 FT 5.0 FD 109.0 | 191.0 104.0 | TEIKIN NO. LKSF 43617 LKXS 43617 LKFX 43617 LKSF 43617A LKXS 43617A LKFX 43617A | |
|  Surface Treatment Tin Coated Bore Clearance MRC: 0.050 mm MP: 20.00 mm | TEIKIN NO. 43617 43617A (43255) | TEIKIN NO. R 43166 | TEIKIN NO. P 43617 | TEIKIN NO. B 43683 | TEIKIN NO. LSF 43168 LSX 43168 LFX 43168 | | 109 | |
| | REFERENCE NO. ME012906 | REFERENCE NO. ME012010 ME012070 | REFERENCE NO. ME012203 ME012249 ME012255 ME012257 | REFERENCE NO. ME011523 ME011604 | | | | |
| 4D31-T LATE 3298 cc 4 cyl. | \emptyset 100.00 -17.5 CD 60.7 TL 110.7 | 1 - 3.0 HK 1 - 2.0 1 - 4.0 | \emptyset 34.000 TL 84.00  | | TL 191.0 OD 104.0 FT 5.0 FD 109.0 | 191.0 104.0 | TEIKIN NO. LKSF 43664A LKXS 43664A LKFX 43664A | |
|  Surface Treatment Tin Coated Bore Clearance MRC: 0.130 mm MP: 27.00 mm | TEIKIN NO. 43664A | TEIKIN NO. R 43664 | TEIKIN NO. P 43664 | TEIKIN NO. B 43170 | TEIKIN NO. LSF 43168 LSX 43168 LFX 43168 | | 110 | |
| | REFERENCE NO. ME012858 | REFERENCE NO. ME012848 ME997396 ME997398 ME999783 | REFERENCE NO. ME012234 | REFERENCE NO. ME011523 ME011604 | | | | |
| 4D32 3567 cc 4 cyl. | \emptyset 104.00 -18.9 CD 60.7 TL 110.6 | 1 - 3.0 HK 1 - 2.0 1 - 4.0 | \emptyset 34.000 TL 83.50  | | TL 197.0 OD 108.0 FT 4.0 FD 113.0 | 197.0 108.0 | TEIKIN NO. LKSF 43227 LKXS 43227 LKFX 43227 LKSF 43227A LKXS 43227A LKFX 43227A | |
|  Surface Treatment Tin Coated Bore Clearance MRC: 0.060 mm MP: 27.00 mm | TEIKIN NO. 43227 43227A | TEIKIN NO. R 43227 | TEIKIN NO. P 39138 | TEIKIN NO. B 43683 | TEIKIN NO. LSF 43227 LSX 43227 LFX 43227 | | 111 | |
| | REFERENCE NO. ME012174 | REFERENCE NO. ME999641 ME997318 ME999243 | REFERENCE NO. ME012203 ME012249 ME012255 ME012257 | REFERENCE NO. ME012900 | | | | |

| ENGINE TYPE | PISTON | PISTON RING | PISTON PIN | PIN BUSHING | LINER | | | LINER KIT SET | | | | |
|--|---|----------------------------------|---|----------------------|--|----------------|---|--|--|--|--|--|
| | | | | | FLANGED | NO FLANGE | | | | | | |
| 4D32 LATE 3567 cc 4 cyl.  Surface Treatment Tin Coated Bore Clearance MRC: 0.040 mm MP: 28.00 mm | \emptyset 104.00 -20.8 CD 62.3 TL 112.3 | 1 - 2.8 FK 1 - 2.0 1 - 4.0 | \emptyset 34.000 TL 83.50  | | TL 197.0 OD 108.0 FT 4.0 FD 113.0 | 197.0 108.0 | TEIKIN NO. LKSF 43619 LKSX 43619 LKFX 43619 LKSF 43619A LKSX 43619A LKFX 43619A TEIKIN NO. 43619 43619A (43260) REFERENCE NO. ME018277 | TEIKIN NO. R 43170 REFERENCE NO. ME997240 ME996566 | TEIKIN NO. P 39138 REFERENCE NO. ME012234 | TEIKIN NO. B 43170 REFERENCE NO. ME012900 | TEIKIN NO. LSF 43227 LSX 43227 LFX 43227 REFERENCE NO. ME012900 | TEIKIN NO. LKSF 43619 LKSX 43619 LKFX 43619 LKSF 43619A LKSX 43619A LKFX 43619A |
| | TEIKIN NO. | TEIKIN NO. | TEIKIN NO. | TEIKIN NO. | TEIKIN NO. | | | | | | | |
| | REFERENCE NO. | REFERENCE NO. | REFERENCE NO. | REFERENCE NO. | REFERENCE NO. | | | | | | | |
| | | | | | | | | | | | | |
| 4D32 NEW 3567 cc 4 cyl.  Surface Treatment Tin Coated Bore Clearance MRC: 0.050 mm MP: 27.00 mm | \emptyset 104.00 -18.9 CD 60.7 TL 110.7 | 1 - 2.8 FK 1 - 2.0 1 - 4.0 | \emptyset 34.000 TL 83.50  | | TL 197.0 OD 108.0 FT 4.0 FD 113.0 | 197.0 108.0 | TEIKIN NO. LKSF 43666 LKSX 43666 LKFX 43666 LKSF 43666A LKSX 43666A LKFX 43666A | TEIKIN NO. R 43170 REFERENCE NO. ME997240 ME996566 | TEIKIN NO. P 39138 REFERENCE NO. ME012234 | TEIKIN NO. B 43170 REFERENCE NO. ME012900 | TEIKIN NO. LSF 43227 LSX 43227 LFX 43227 REFERENCE NO. ME012900 | TEIKIN NO. LKSF 43666 LKSX 43666 LKFX 43666 LKSF 43666A LKSX 43666A LKFX 43666A |
| | TEIKIN NO. | TEIKIN NO. | TEIKIN NO. | TEIKIN NO. | TEIKIN NO. | | | | | | | |
| | REFERENCE NO. | REFERENCE NO. | REFERENCE NO. | REFERENCE NO. | REFERENCE NO. | | | | | | | |
| | | | | | | | | | | | | |
| 4D34 3907 cc PS120 4 cyl.  Surface Treatment Tin Coated Bore Clearance MRC: 0.050 mm MP: 27.50 mm | \emptyset 104.00 -20.5 CD 62.2 TL 112.2 | 1 - 2.8 FK 1 - 2.0 1 - 4.0 | \emptyset 34.000 TL 83.50  | | TL 200.0 OD 108.0 FT 4.0 FD 113.0 | 200.0 108.0 | TEIKIN NO. LKSF 43170 LKSX 43170 LKFX 43170 LKSF 43170A LKSX 43170A LKFX 43170A | TEIKIN NO. R 43170 REFERENCE NO. ME997240 ME996566 | TEIKIN NO. P 39138 REFERENCE NO. ME012234 | TEIKIN NO. B 43170 REFERENCE NO. ME013366 | TEIKIN NO. LSF 43170 LSX 43170 LFX 43170 REFERENCE NO. ME013366 | TEIKIN NO. LKSF 43170 LKSX 43170 LKFX 43170 LKSF 43170A LKSX 43170A LKFX 43170A |
| | TEIKIN NO. | TEIKIN NO. | TEIKIN NO. | TEIKIN NO. | TEIKIN NO. | | | | | | | |
| | REFERENCE NO. | REFERENCE NO. | REFERENCE NO. | REFERENCE NO. | REFERENCE NO. | | | | | | | |
| | | | | | | | | | | | | |
| 4D34T 3907 cc 4 cyl.  Surface Treatment Tin Coated Bore Clearance MRC: 0.090 mm MP: 27.00 mm | \emptyset 104.00 -20.6 CD 62.2 TL 112.2 | 1 - 2.8 FK 1 - 2.0 1 - 4.0 | \emptyset 36.000 TL 88.00  | | TL 200.0 OD 108.0 FT 4.0 FD 113.0 | 200.0 108.0 | TEIKIN NO. LKSF 43605 LKSX 43605 LKFX 43605 LKSF 43605A LKSX 43605A LKFX 43605A | TEIKIN NO. R 43170 REFERENCE NO. ME997240 ME996566 | TEIKIN NO. P 43608 REFERENCE NO. ME013075 | TEIKIN NO. B 43280 REFERENCE NO. ME013366 | TEIKIN NO. LSF 43170 LSX 43170 LFX 43170 REFERENCE NO. ME013366 | TEIKIN NO. LKSF 43605 LKSX 43605 LKFX 43605 LKSF 43605A LKSX 43605A LKFX 43605A |
| | TEIKIN NO. | TEIKIN NO. | TEIKIN NO. | TEIKIN NO. | TEIKIN NO. | | | | | | | |
| | REFERENCE NO. | REFERENCE NO. | REFERENCE NO. | REFERENCE NO. | REFERENCE NO. | | | | | | | |
| | | | | | | | | | | | | |







112



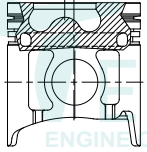

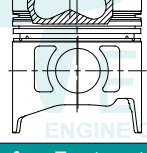

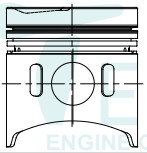

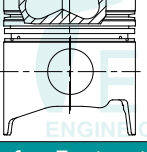
113

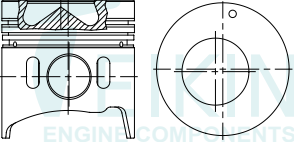
114

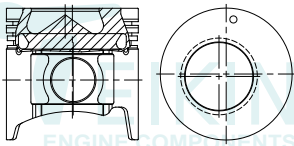
115

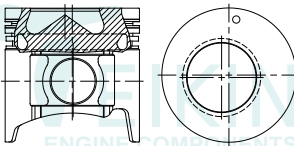
M

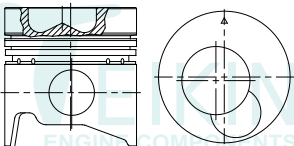
| ENGINE TYPE | PISTON | PISTON RING | PISTON PIN | PIN BUSHING | LINER | | | LINER KIT SET |
|---|--|--|---|--|---|-------------------------|---|---------------|
| | | | | | FLANGED | NO FLANGE | | |
| 4D34T NEW 3907 cc HYUNDAI D4DB 4 cyl. | \emptyset 104.00 -22.9 CD 62.2 TL 112.1 | 1 - 3.0 FK 1 - 2.0 1 - 4.0 | \emptyset 36.000 TL 88.00  | | TL 200.0 OD 108.0 FT 4.0 FD 113.0 | 200.0 108.0 108.0 | TEIKIN NO. LKSF 43293 LKSX 43293 LKSF 43293A LKSX 43293A LKSF 43293AG LKSF 43293AG | |
|  Surface Treatment Tin Coated Bore Clearance MRC: 0.140 mm MP: 27.00 mm | TEIKIN NO. 43293 43293A 43293AG REFERENCE NO. ME220470 ME011143 23411-45700 | TEIKIN NO. R 43170 REFERENCE NO. ME997240 ME996566 | TEIKIN NO. P 43608 REFERENCE NO. ME013075 | TEIKIN NO. B 43280 REFERENCE NO. ME013075 | TEIKIN NO. LSF 43170 LSX 43170 REFERENCE NO. ME013366 | | 116 | |
| 4D34T-II 3907 cc 4 cyl. | \emptyset 104.00 -20.5 CD 62.2 TL 112.2 | 1 - 2.8 FK 1 - 2.0 1 - 4.0 | \emptyset 36.000 TL 88.00  | | TL 200.0 OD 108.0 FT 4.0 FD 113.0 | 200.0 108.0 | TEIKIN NO. LKSX 43693A LKSF 43693A LKFX 43693A | |
|  Surface Treatment Tin Coated Bore Clearance MRC: 0.100 mm MP: 27.00 mm | TEIKIN NO. 43693A REFERENCE NO. ME013325 | TEIKIN NO. R 43170 REFERENCE NO. ME997240 ME996566 | TEIKIN NO. P 43608 REFERENCE NO. ME013075 | TEIKIN NO. B 43280 REFERENCE NO. ME013075 | TEIKIN NO. LSX 43170 LSF 43170 LFX 43170 REFERENCE NO. ME013366 | | 117 | |
| 4D36 3567 cc 4 cyl. | \emptyset 104.00 -4.6 CD 60.6 TL 110.6 | 1 - 3.0 FK 1 - 2.0 1 - 4.0 | \emptyset 34.000 TL 83.50  | | TL 197.0 OD 108.0 FT 4.0 FD 113.0 | 197.0 108.0 | TEIKIN NO. LKSF 43280 LKSX 43280 LKFX 43280 LKSF 43280A LKSX 43280A LKFX 43280A | |
|  Surface Treatment Tin Coated Anodized Crown Bore Clearance MRC: 0.050 mm MP: 26.50 mm | TEIKIN NO. 43280 43280A REFERENCE NO. ME018283 | TEIKIN NO. R 43170 REFERENCE NO. ME997240 ME996566 | TEIKIN NO. P 39138 REFERENCE NO. ME013075 | TEIKIN NO. B 43280 REFERENCE NO. ME013075 | TEIKIN NO. LSF 43227 LSX 43227 LFX 43227 REFERENCE NO. ME012900 | | 118 | |
| 6D34T 5861 cc 6 cyl. | \emptyset 104.00 -20.6 CD 62.2 TL 112.2 | 1 - 2.8 FK 1 - 2.0 1 - 4.0 | \emptyset 36.000 TL 88.00  | | TL 200.0 OD 108.0 FT 4.0 FD 113.0 | 200.0 108.0 | TEIKIN NO. LKSF 43605-6 LKSX 43605-6 | |
|  Surface Treatment Tin Coated Bore Clearance MRC: 0.090 mm MP: 27.00 mm | TEIKIN NO. 43605-6 REFERENCE NO. ME013325 ME014160 | TEIKIN NO. R 43605-6 REFERENCE NO. ME996442 | TEIKIN NO. P 43608 REFERENCE NO. ME013075 | TEIKIN NO. B 43605-6 REFERENCE NO. ME013075 | TEIKIN NO. LSF 43605-6 LSX 43605-6 REFERENCE NO. ME012900 ME013366 | | 119 | |









| ENGINE TYPE | PISTON | PISTON RING | PISTON PIN | PIN BUSHING | LINER | | LINER KIT SET |
|--|--|--|---|--|--|----------------|--|
| | | | | | FLANGED | NO FLANGE | |
| 4D33 4214 cc 4 cyl.  | \varnothing 108.00 -20.8 CD 62.2 TL 112.2 | 1 - 3.0 1 - 2.0 1 - 4.0 | \varnothing 34.000 TL 83.50  | | TL 205.0 OD 112.0 FT 5.0 FD 117.0 | 200.0 112.0 | TEIKIN NO. LKSF 43244 LKSX 43244 LKFX 43244 LKSF 43244A LKSX 43244A LKFX 43244A |
| | TEIKIN NO. 43244 43244A | TEIKIN NO. R 43244 | TEIKIN NO. P 39138 | TEIKIN NO. B 43170 | TEIKIN NO. LSF 43244 LSX 43244 LFX 43244 | | |
| | REFERENCE NO. ME012897 ME013312 ME016895 | REFERENCE NO. ME999871 ME996378 | REFERENCE NO. ME012234 | REFERENCE NO. ME013333 | | | |
| | Surface Treatment Tin Coated Bore Clearance MRC: 0.080 mm MP: 27.00 mm | 120 | | | | | |
| 4D35 4561 cc 4 cyl.  | \varnothing 110.00 -21.4 CD 59.8 TL 109.6 | 1 - 3.0 1 - 2.5 1 - 4.0 | \varnothing 36.000 TL 88.00  | | TL 205.0 OD 114.0 FT 5.0 FD 119.0 | 200.0 114.0 | TEIKIN NO. LKSF 43608 LKSX 43608 LKFX 43608 LKSF 43608A LKSX 43608A LKFX 43608A LKSF 43608AG LKSX 43608AG LKFX 43608AG |
| | TEIKIN NO. 43608 43608A 43608AG (43237) | TEIKIN NO. R 43608 | TEIKIN NO. P 43608 | TEIKIN NO. B 43280 | TEIKIN NO. LSF 43608 LSX 43608 LFX 43608 | | |
| | REFERENCE NO. ME018825 ME012941 | REFERENCE NO. ME996628 | REFERENCE NO. ME013075 | REFERENCE NO. ME013678 | | | |
| | Surface Treatment Tin Coated Bore Clearance MRC: 0.100 mm MP: 26.50 mm | 121 | | | | | |
| 4D35 / 4D35T 4561 cc 4 cyl.  | \varnothing 110.00 -21.5 CD 59.7 TL 109.6 | 1 - 3.0 1 - 2.0 1 - 4.0 | \varnothing 36.000 TL 88.00  | | TL 205.0 OD 114.0 FT 5.0 FD 119.0 | 200.0 114.0 | TEIKIN NO. LKSX 43691AG LKSF 43691AG LKFX 43691AG |
| | TEIKIN NO. 43691AG | TEIKIN NO. R 43691 | TEIKIN NO. P 43608 | TEIKIN NO. B 43280 | TEIKIN NO. LSX 43608 LSF 43608 LFX 43608 | | |
| | REFERENCE NO. ME014693 | REFERENCE NO. ME995214 | REFERENCE NO. ME013075 | REFERENCE NO. ME013678 | | | |
| | Surface Treatment Tin Coated Bore Clearance MRC: 0.080 mm MP: 26.50 mm | 122 | | | | | |
| 6D14 6557 cc FUSO FR 6 cyl.  | \varnothing 110.00 -21.0 CD 71.1 TL 116.1 | 1 - 3.0 HK 1 - 2.5 1 - 5.0 | \varnothing 38.000 TL 90.00  | | TL 206.0 OD 122.0 FT 10.0 +1.4 FD 130.6 | | TEIKIN NO. LKFF 43102 LKSF 43102 LKFF 43102A LKSF 43102A |
| | TEIKIN NO. 43102 43102A | TEIKIN NO. R 43102 | TEIKIN NO. P 43102 | TEIKIN NO. B 43102 | TEIKIN NO. LFF 43102 LFX 43102 | | |
| | REFERENCE NO. ME032626 ME033908 ME032216/98 ME032619/21 | REFERENCE NO. ME032071/260 ME032404/58 ME033904 ME997423/39 | REFERENCE NO. ME032014 ME032015 ME033943 | REFERENCE NO. ME031453/63 ME031508/10 ME031617/18 ME071174/98 | | | |
| | Surface Treatment Tin Coated Bore Clearance MRC: 0.130 mm MP: 22.00 mm | 123 | | | | | |

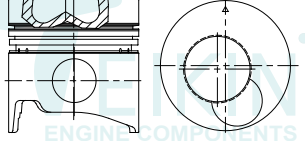

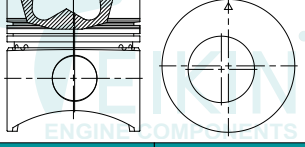

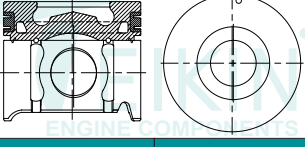

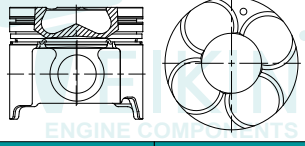

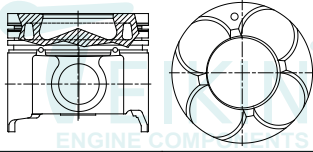

| ENGINE TYPE | PISTON | PISTON RING | PISTON PIN | PIN BUSHING | LINER | | LINER KIT SET |
|---|---|--|--------------------------------------|--|--|-----------|---|
| | | | | | FLANGED | NO FLANGE | |
| 6D14.3AT 6557 cc 6 cyl. Surface Treatment Bore Clearance Tin Coated MRC: 0.140 mm MP: 22.00 mm | \varnothing 110.00 -21.5 CD 71.1 TL 116.1 | 1 - 2.8 FK 1 - 2.5 1 - 4.0 | \varnothing 38.000 TL 90.00 | | TL 210.0 OD 122.0 FT 10.0 +1.4 FD 130.7 | | TEIKIN NO. LKFF 43684A |
| | TEIKIN NO. 43684A | TEIKIN NO. R 43684 | TEIKIN NO. P 43684 | TEIKIN NO. B 43223 | TEIKIN NO. LFF 43684 | | |
| | REFERENCE NO. ME072047 | REFERENCE NO. ME997465 | | REFERENCE NO. ME072128 | REFERENCE NO. ME071175 ME071199 | | |
| | | | | | | | |
| 6D14.A 6 cyl. Surface Treatment Bore Clearance Tin Coated MRC: 0.140 mm MP: 10.00 mm | \varnothing 110.00 -21.0 CD 71.1 TL 116.1 | 1 - 3.0 HK 1 - 2.5 1 - 5.0 | \varnothing 38.000 TL 90.00 | | TL 206.0 OD 122.0 FT 10.0 +1.4 FD 130.6 | | TEIKIN NO. LKFF 43289 LKSF 43289 |
| | TEIKIN NO. 43289 | TEIKIN NO. R 43102 | TEIKIN NO. P 43102 | TEIKIN NO. B 43102 | TEIKIN NO. LFF 43102 LSF 43102 | | |
| | REFERENCE NO. ME032654 ME032656 ME033916 | REFERENCE NO. ME032071/260 ME032404/58 ME033904 ME997423/39 | | REFERENCE NO. ME032014 ME032015 ME033943 | REFERENCE NO. ME031453/63 ME031508/10 ME031617/18 ME071174/98 | | |
| | | | | | | | |
| 6D14-T 6557 cc 6 cyl. Surface Treatment Bore Clearance Tin Coated MRC: 0.120 mm MP: 10.00 mm | \varnothing 110.00 -20.0 CD 71.1 TL 116.1 | 1 - 3.0 HK 1 - 2.5 1 - 5.0 | \varnothing 38.000 TL 90.00 | | TL 206.0 OD 122.0 FT 10.0 +1.4 FD 130.6 | | TEIKIN NO. LKFF 43615 LKSF 43615 LKFF 43615A LKSF 43615A |
| | TEIKIN NO. 43615 43615A (43253) | TEIKIN NO. R 43102 | TEIKIN NO. P 43102 | TEIKIN NO. B 43102 | TEIKIN NO. LFF 43102 LSF 43102 | | |
| | REFERENCE NO. ME032569 | REFERENCE NO. ME032071/260 ME032404/58 ME033904 ME997423/39 | | REFERENCE NO. ME032014 ME032015 ME033943 | REFERENCE NO. ME031453/63 ME031508/10 ME031617/18 ME071174/98 | | |
| | | | | | | | |
| 6D14-T .2A 6557 cc 6 cyl. Surface Treatment Bore Clearance Tin Coated MRC: 0.130 mm MP: 0.20 mm | \varnothing 110.00 -20.6 CD 71.1 TL 116.1 | 1 - 3.0 1 - 2.5 1 - 4.0 | \varnothing 38.000 TL 90.00 | | TL 206.0 OD 122.0 FT 10.0 +1.4 FD 130.6 | | TEIKIN NO. LKFF 43665A LKSF 43665A |
| | TEIKIN NO. 43665A | TEIKIN NO. R 43665 | TEIKIN NO. P 43102 | TEIKIN NO. B 43223 | TEIKIN NO. LFF 43102 LSF 43102 | | |
| | REFERENCE NO. ME072170 ME072064 ME072172 | REFERENCE NO. ME999952 ME999927 | | REFERENCE NO. ME072128 | REFERENCE NO. ME031453/63 ME031508/10 ME031617/18 ME071174/98 | | |
| | | | | | | | |

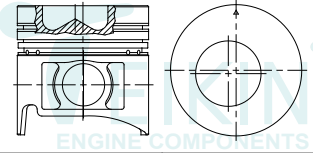
| ENGINE TYPE | PISTON | PISTON RING | PISTON PIN | PIN BUSHING | LINER | | LINER KIT SET |
|--|--|--|--|--|--|-----------|---|
| | | | | | FLANGED | NO FLANGE | |
| 6D14-T-II 6557 cc 6 cyl. | Ø 110.00 -20.3 CD 71.2 TL 116.1 | 1 - 3.0 HK 1 - 2.5 1 - 5.0 | Ø 38.000 TL 90.00 | | TL 206.0 OD 122.0 FT 10.0 +1.4 FD 130.6 | | TEIKIN NO. LKFF 43668A LKSF 43668A |
| | TEIKIN NO. 43668A | TEIKIN NO. R 43102 | TEIKIN NO. P 43102 | TEIKIN NO. B 43102 | TEIKIN NO. LFF 43102 LSF 43102 | | 128 |
| Surface Treatment Tin Coated | Bore Clearance MRC: 0.120 mm MP: 10.00 mm | REFERENCE NO. ME032742 | REFERENCE NO. ME032071/260 ME032404/58 ME033904 ME997423/39 | REFERENCE NO. ME032014 ME032015 ME033943 | REFERENCE NO. ME031453/63 ME031508/10 ME031617/18 ME071174/98 | | |
| 6DB NEW 8550 cc 6 cyl. | Ø 110.00 -12.1 CD 77.5 TL 152.5 | 1 - 3.5 2 - 2.5 1 - 5.0 | Ø 40.000 TL 95.00 | | TL 270.0 OD 125.9 FT 11.8 FD 134.5 | | |
| | TEIKIN NO. 43107 43107A | TEIKIN NO. R 43107 | TEIKIN NO. P 43107 | TEIKIN NO. B 43107 | TEIKIN NO. LFF43107 | | 129 |
| Surface Treatment None | Bore Clearance MRC: 0.100 mm MP: 37.00 mm | REFERENCE NO. 30017-90100 30017-92101 | REFERENCE NO. 30017-71002/3 30017-73002 30017-75002/3 | REFERENCE NO. 30019-20601 | REFERENCE NO. 30007-62200 ME040040 | | |
| 6D15 6919 cc 6 cyl. | Ø 113.00 -21.2 CD 71.1 TL 116.1 | 1 - 3.0 HK 1 - 2.5 1 - 5.0 | Ø 38.000 TL 90.00 | | TL 206.0 OD 125.0 FT 10.0 +1.5 FD 132.8 | | |
| | TEIKIN NO. 43104 43104A | TEIKIN NO. R 43104 | TEIKIN NO. P 43102 | TEIKIN NO. B 43102 | TEIKIN NO. LFF 43104 | | 130 |
| Surface Treatment Tin Coated | Bore Clearance MRC: 0.130 mm MP: 21.50 mm | REFERENCE NO. ME032661 ME072033 ME072035 ME033934 | REFERENCE NO. ME032403 ME072306 | REFERENCE NO. ME032014 ME032015 ME033943 | REFERENCE NO. ME031654 ME031656 ME071041 ME071063 | | |
| 6D15.3AT 6919 cc 6 cyl. | Ø 113.00 -21.4 CD 71.1 TL 116.1 | 1 - 2.8 FK 1 - 2.5 1 - 4.0 | Ø 38.000 TL 92.00 | | TL 206.0 OD 117.0 FT 8.0 +1.5 FD 125.0 | | |
| | TEIKIN NO. 43675A | TEIKIN NO. R 43675 | TEIKIN NO. P 43675 | TEIKIN NO. B 43223 | TEIKIN NO. LFF 43675 | | 131 |
| Surface Treatment Tin Coated | Bore Clearance MRC: 0.120 mm MP: 16.00 mm | REFERENCE NO. ME072055 | REFERENCE NO. ME997456 ME997466 ME999929 ME999954 | REFERENCE NO. ME072128 | REFERENCE NO. ME047574 ME071086/87 ME071088/89 ME071090/91/92 | | |

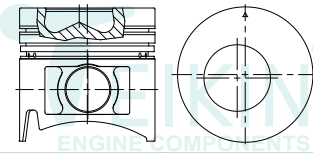

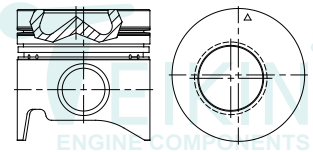







| ENGINE TYPE | PISTON | PISTON RING | PISTON PIN | PIN BUSHING | LINER | | LINER KIT SET |
|--|--|--|---|--|--|----------------|---|
| | | | | | FLANGED | NO FLANGE | |
| 6D15-II 6 cyl.  | \varnothing 113.00 -21.2 CD 71.1 TL 116.1 | 1 - 3.0 HK 1 - 2.5 1 - 5.0 | \varnothing 38.00 TL 90.00  | | TL 211.0 OD 125.0 FT 10.0 +1.5 FD 132.8 | | TEIKIN NO. LKFF 43283 LKFF 43283A |
| | TEIKIN NO. 43283 43283A | TEIKIN NO. R 43104 | TEIKIN NO. P 43102 | TEIKIN NO. B 43102 | TEIKIN NO. LFF 43283 | | |
| | REFERENCE NO. ME032870 ME032871 | REFERENCE NO. ME032403 ME072306 | REFERENCE NO. ME032014 ME032015 ME033943 | REFERENCE NO. ME071062 ME071063 ME071064 | | | |
| | Surface Treatment Bore Clearance Tin Coated MRC: 0.130 mm MP: 21.50 mm | | | | | | 132 |
| 6D15-III 6919 cc 6 cyl.  | \varnothing 113.00 -21.4 CD 70.8 TL 115.8 | 1 - 3.0 HK 1 - 2.5 1 - 5.0 | \varnothing 38.00 TL 90.00  | | TL 206.0 OD 125.0 FT 10.0 +1.5 FD 132.8 | | TEIKIN NO. LKFF 43686A |
| | TEIKIN NO. 43686A | TEIKIN NO. R 43104 | TEIKIN NO. P 43684 | TEIKIN NO. B 43102 | TEIKIN NO. LFF 43104 | | |
| | REFERENCE NO. ME032593 ME032480 ME032634 ME033963 | REFERENCE NO. ME032403 ME072306 | REFERENCE NO. ME032014 ME032015 ME033943 | REFERENCE NO. ME031654 ME031656 ME071041 | | | |
| | Surface Treatment Bore Clearance Tin Coated MRC: 0.140 mm MP: 20.00 mm | | | | | | 133 |
| 4M50T 4899 cc 4 cyl.  | \varnothing 114.00 -21.0 CD 59.1 TL 99.1 | 1 - 3.0 FK 1 - 2.0 1 - 4.0 | \varnothing 38.00 TL 93.00  | | TL 199.0 OD 118.0 FT 6.0 FD 123.8 | 199.0 118.0 | TEIKIN NO. LKSF 43685AG LKSF 43685AG |
| | TEIKIN NO. 43685AG | TEIKIN NO. R 43685 | TEIKIN NO. P 43685 | TEIKIN NO. B 43685 | TEIKIN NO. LSF 43685 LSX 43685 | | |
| | REFERENCE NO. ME224532 ME224533 ME226782 ME226783 | REFERENCE NO. ME993913 | REFERENCE NO. ME221709 | REFERENCE NO. ME221709 | | | |
| | Surface Treatment Bore Clearance Anodized Crown Moly Skirt MRC: 0.190 mm MP: 15.00 mm | | | | | | 134 |
| 4M51 4 cyl.  | \varnothing 118.00 -23.3 CD 59.1 TL 99.1 | 1 - 3.0 1 - 2.0 1 - 3.0 | \varnothing 34.000 TL 84.00  | | TL 195.0 OD 122.0 FT 5.0 FD 127.0 | 190.0 122.0 | TEIKIN NO. LKSF 43674A LKSF 43674A |
| | TEIKIN NO. 43674A | TEIKIN NO. R 43674 | TEIKIN NO. P 43674 | TEIKIN NO. B 43683 | TEIKIN NO. LSF 43674 LSX 43674 | | |
| | REFERENCE NO. ME240047 | REFERENCE NO. ME995591 | REFERENCE NO. ME012203 ME012249 ME012255 ME012257 | REFERENCE NO. ME012203 ME012249 ME012255 ME012257 | | | |
| | Surface Treatment Bore Clearance Tin Coated MRC: 0.120 mm MP: 14.50 mm | | | | | | 135 |

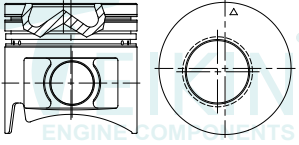

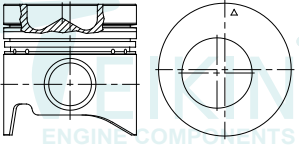

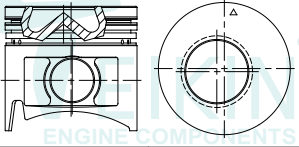

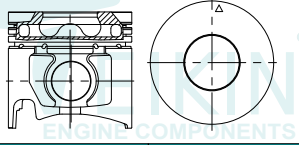

| ENGINE TYPE | PISTON | PISTON RING | PISTON PIN | PIN BUSHING | LINER | | LINER KIT SET |
|---|---|--|---|--|--|----------------|---|
| | | | | | FLANGED | NO FLANGE | |
| 4M51T 5249 cc 4 cyl.  Surface Treatment Tin Coated Bore Clearance MRC: 0.120 mm MP: 17.00 mm | \emptyset 118.00 -22.0 CD 59.1 TL 99.1 | 1 - 3.0 1 - 2.0 1 - 4.0 | \emptyset 34.000 TL 84.00  | | TL 190.0 OD 122.0 FT 5.0 FD 127.0 | 190.0 122.0 | TEIKIN NO. LKSF 43683 LKSX 43683 LKSF 43683A LKSX 43683A LKSF 43683AG LKSF 43683AG |
| | TEIKIN NO. 43683 43683A 43683AG | TEIKIN NO. R 43683 | TEIKIN NO. P 43683 | TEIKIN NO. B 43683 | TEIKIN NO. LSF 43674 LSX 43674 | | |
| | REFERENCE NO. ME241686 ME241688 | REFERENCE NO. ME995591/2/3 | | REFERENCE NO. ME012203 ME012249 ME012255 ME012257 | REFERENCE NO. | | |
| | | | | | | | |
| 6D16 7545 cc 6 cyl.  Surface Treatment Tin Coated Bore Clearance MRC: 0.060 mm MP: 20.10 mm | \emptyset 118.00 -22.0 CD 71.1 TL 116.1 | 1 - 3.0 1 - 2.5 1 - 4.0 | \emptyset 38.000 TL 92.50  | | TL 205.0 OD 122.0 FT 8.0 FD 128.0 | | TEIKIN NO. LKFF 43105 LKSF 43105 LKFF 43105A LKSF 43105A |
| | TEIKIN NO. 43105 43105A | TEIKIN NO. R 43105 | TEIKIN NO. P 43105 | TEIKIN NO. B 43105 | TEIKIN NO. LFF 43105 LSF 43105 | | |
| | REFERENCE NO. ME072062 | REFERENCE NO. ME999540 ME999955 | | REFERENCE NO. ME035380 ME035381 ME072126 | REFERENCE NO. ME071224 ME071226/7/8 ME071230 | | |
| | | | | | | | |
| 6D16-1A 7545 cc 6 cyl.  Surface Treatment Tin Coated Bore Clearance MRC: 0.060 mm MP: 20.10 mm | \emptyset 118.00 -21.5 CD 71.1 TL 116.1 | 1 - 3.0 1 - 2.5 1 - 4.0 | \emptyset 38.000 TL 92.50  | | | | TEIKIN NO. |
| | TEIKIN NO. 43268A | | TEIKIN NO. P 43105 | | | | |
| | REFERENCE NO. ME072326 | | | | | | |
| | | | | | | | |
| 6D16-1AT2 7545 cc 6 cyl.  Surface Treatment Tin Coated Bore Clearance MRC: 0.120 mm MP: 22.00 mm | \emptyset 118.00 -22.3 CD 71.1 TL 116.1 | 1 - 3.0 FK 1 - 2.5 1 - 4.0 | \emptyset 38.000 TL 92.50  | | | | TEIKIN NO. |
| | TEIKIN NO. 43265A | | TEIKIN NO. P 43105 | | | | |
| | REFERENCE NO. ME072316 | | | | | | |
| | | | | | | | |

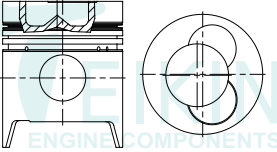
138

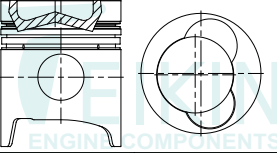

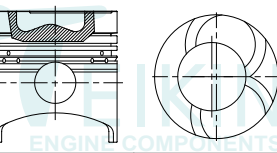

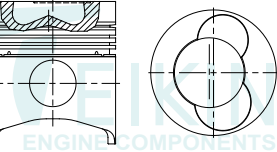
139

M

| ENGINE TYPE | PISTON | PISTON RING | PISTON PIN | PIN BUSHING | LINER | | LINER KIT SET |
|--|---|--|---|----------------------------------|--|-----------|---|
| | | | | | FLANGED | NO FLANGE | |
| 6D16-2A 7545 cc 6 cyl.  Surface Treatment Bore Clearance Tin Coated MRC: 0.070 mm MP: 19.00 mm | \emptyset 118.00 -21.1 CD 71.1 TL 116.0 | 1 - 3.0 1 - 2.5 1 - 4.0 | \emptyset 38.000 TL 92.50  | | | | TEIKIN NO. 140 |
| | TEIKIN NO. 43266A | | TEIKIN NO. P 43105 | | | | |
| | REFERENCE NO. ME072574 | | | | | | |
| | | | | | | | |
| 6D16-T 7545 cc 6 cyl.  Surface Treatment Bore Clearance Tin Coated MRC: 0.120 mm MP: 22.00 mm | \emptyset 118.00 -23.0 CD 71.1 TL 116.1 | 1 - 2.8 FK 1 - 2.5 1 - 4.0 | \emptyset 38.000 TL 92.50  | | TL 206.0 OD 122.0 FT 8.0 +1.5 FD 128.0 | | TEIKIN NO. LKFF 43233 LKSF 43233 LKFF 43233A LKSF 43233A |
| | TEIKIN NO. 43223 43223A | TEIKIN NO. R 43223 | TEIKIN NO. P 43105 | TEIKIN NO. B 43223 | TEIKIN NO. LFF 43223 LSF 43223 | | |
| | REFERENCE NO. ME072065 | REFERENCE NO. ME996591 ME997467 ME997999 ME999549 | | REFERENCE NO. ME072128 | REFERENCE NO. ME041102 ME041105 ME041107 | | |
| | | | | | | | |
| 6D17-1A 8201 cc 6 cyl.  Surface Treatment Bore Clearance Tin Coated MRC: 0.060 mm MP: 19.00 mm | \emptyset 118.00 -23.1 CD 66.1 TL 111.1 | 1 - 3.0 1 - 2.5 1 - 4.0 | \emptyset 38.000 TL 92.50  | | TL 209.0 OD 122.0 FT 8.0 FD 128.0 | | TEIKIN NO. LKFF 43267 LKFF 43267A |
| | TEIKIN NO. 43267 43267A | TEIKIN NO. R 43105 | TEIKIN NO. P 43105 | TEIKIN NO. B 43223 | TEIKIN NO. LFF 43267 | | |
| | REFERENCE NO. ME072576 | REFERENCE NO. ME999540 ME999555 | | REFERENCE NO. ME072128 | REFERENCE NO. ME071125/225 ME071537 ME071538 ME071543 | | |
| | | | | | | | |
| 6M61 8201 cc 6 cyl.  Surface Treatment Bore Clearance Tin Coated MRC: 0.080 mm MP: 20.00 mm | \emptyset 118.00 -23.8 CD 66.1 TL 111.2 | 1 - 3.0 1 - 2.0 1 - 4.0 | \emptyset 38.000 TL 93.00  | | TL 209.0 OD 122.0 FT 8.0 FD 127.9 | | TEIKIN NO. LKFF 43695AG |
| | TEIKIN NO. 43695AG | TEIKIN NO. R 43695 | TEIKIN NO. P 43695 | TEIKIN NO. B 43233 | TEIKIN NO. LFF 43267 | | |
| | REFERENCE NO. ME131937 | REFERENCE NO. ME995562 ME995568 | | REFERENCE NO. ME072128 | REFERENCE NO. ME071125 ME071537 ME071538 ME071543 | | |
| | | | | | | | |

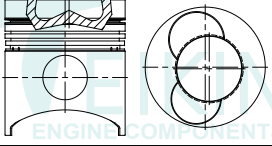

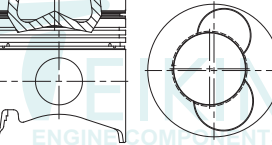
| ENGINE TYPE | PISTON | PISTON RING | PISTON PIN | PIN BUSHING | LINER | | LINER KIT SET | |
|--|---|---|--|---|--|-----------|--|------------|
| | | | | | FLANGED | NO FLANGE | | |
| 6D22 11149 cc 6 cyl.  | \emptyset 130.00 -26.3 CD 82.9 TL 158.0 | 1 - 3.5 FK 1 - 3.0 1 - 6.0 | \emptyset 50.000 TL 105.00  | | TL 262.0 OD 147.0 FT 11.5 +1.8 FD 156.0 | | TEIKIN NO. LKFF 43614 LKFF 43614A | |
| | TEIKIN NO. 43614 43614A (43251) | TEIKIN NO. R 43614 | TEIKIN NO. P 43274 | TEIKIN NO. B 43614 | TEIKIN NO. LFF 43614 | | | |
| | REFERENCE NO. ME052447 | REFERENCE NO. ME052124 ME052787 30917-20010 | | REFERENCE NO. ME052158/9 ME052603/60 30319-00600 30319-00690 | REFERENCE NO. ME051217 ME051500 ME051501 ME051502 | | | |
| | Surface Treatment Bore Clearance Tin Coated MRC: 0.180 mm MP: 39.50 mm | | | | | | | 144 |
| 6D22-T 11149 cc 6 cyl.  | \emptyset 130.00 -21.7 CD 83.1 TL 158.1 | 1 - 3.5 FK 1 - 3.0 1 - 4.0 | \emptyset 50.000 TL 105.00  | | | | TEIKIN NO. | |
| | TEIKIN NO. 43274 43274A | | TEIKIN NO. P 43274 | | | | | |
| | REFERENCE NO. ME052540 | | | | | | | |
| | Surface Treatment Bore Clearance Tin Coated MRC: 0.180 mm MP: 39.50 mm | | | | | | | 145 |
| 8DC8 14886 cc 8 cyl.  | \emptyset 135.00 -23.0 CD 78.0 TL 142.8 | 1 - 4.0 HK 1 - 3.0 1 - 6.0 | \emptyset 45.000 TL 108.00  | | TL 229.3 OD 154.0 FT 11.8 +1.0 FD 163.0 | | TEIKIN NO. LKFF 43618 LKFF 43618A | |
| | TEIKIN NO. 43618 43618A (43259) | TEIKIN NO. R 43618 | TEIKIN NO. P 43618 | TEIKIN NO. B 43618 | TEIKIN NO. LFF 43618 | | | |
| | REFERENCE NO. ME062086 31217-60012 | REFERENCE NO. ME062086 31217-60012 | | REFERENCE NO. 31219-70600 | REFERENCE NO. 31207-72183 | | | |
| | Surface Treatment Bore Clearance Tin Coated MRC: 0.170 mm MP: 18.00 mm | | | | | | | 146 |
| 8DC9 16031 cc 8 cyl.  | \emptyset 135.00 -26.0 CD 88.0 TL 153.0 | 1 - 3.3 FK 2 - 3.0 1 - 6.0 | \emptyset 50.000 TL 112.00  | | TL 260.0 OD 154.0 FT 11.8 +1.2 FD 163.0 | | TEIKIN NO. LKFF 43660A | |
| | TEIKIN NO. 43660A | TEIKIN NO. R 43660 | TEIKIN NO. P43660 | TEIKIN NO. B 43275 | TEIKIN NO. LFF 43275 | | | |
| | REFERENCE NO. ME062408 | REFERENCE NO. ME062018 ME062230 | | REFERENCE NO. ME062310 31219-34300 31219-34390 | REFERENCE NO. ME061782 | | | |
| | Surface Treatment Bore Clearance Tin Coated MRC: 0.130 mm MP: 27.00 mm | | | | | | | 147 |



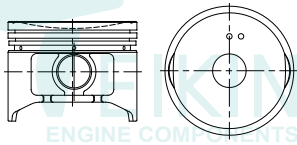
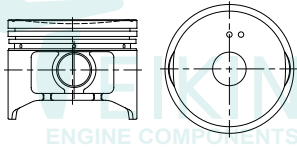
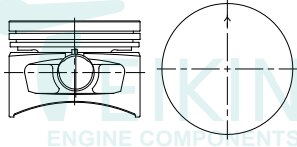
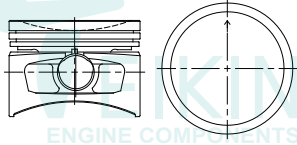

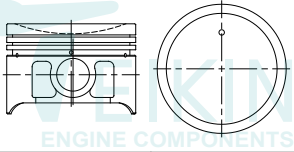
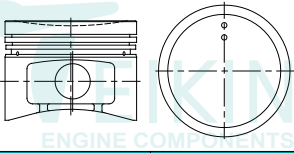

M

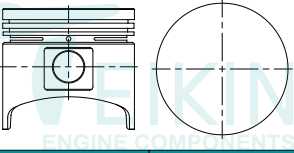
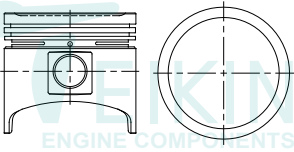
| ENGINE TYPE | PISTON | PISTON RING | PISTON PIN | PIN BUSHING | LINER | | LINER KIT SET | |
|---|---|---|--|--|--|-----------|----------------------------------|------------|
| | | | | | FLANGED | NO FLANGE | | |
| 8DC91-T 16031 cc 8 cyl.  Surface Treatment Bore Clearance Tin Coated MRC: 0.120 mm MP: 34.25 mm | \emptyset 135.00 -24.3 CD 88.1 TL 153.0 | 1 - 3.5 FK 2 - 3.0 1 - 4.0 | \emptyset 50.000 TL 111.50  | | TL 260.0 OD 154.0 FT 11.8 +1.2 FD 163.0 | | TEIKIN NO. LKFF 43275A | |
| | TEIKIN NO. 43275A | TEIKIN NO. R 43275 | TEIKIN NO. P 43275 | TEIKIN NO. B 43275 | TEIKIN NO. LFF 43275 | | | |
| | REFERENCE NO. ME090163 ME091048 | REFERENCE NO. ME090578 | | REFERENCE NO. ME062310 31219-34300 31219-34390 | REFERENCE NO. ME061782 | | | |
| | | | | | | | | 148 |
| 8DC11 16752 cc 8 cyl.  Surface Treatment Bore Clearance MRC: 0.190 mm MP: 40.00 mm | \emptyset 142.00 -25.3 CD 88.1 TL 153.1 | 1 - 3.3 H.K 2 - 3.0 1 - 4.0 | \emptyset 50.000 TL 112.00  | | TL 259.0 OD 154.0 FT 201.3 +1.7 FD 163.0 | | TEIKIN NO. LKFF 43659A | |
| | TEIKIN NO. 43659A | TEIKIN NO. R 43659 | TEIKIN NO. P43659 | TEIKIN NO. B 43275 | TEIKIN NO. LFF 43659 | | | |
| | REFERENCE NO. ME091050 | REFERENCE NO. 30617-50111 ME090586 ME999990 | | REFERENCE NO. ME062310 31219-34300 31219-34390 | REFERENCE NO. ME060439 ME060440 ME060441 | | | |
| | | | | | | | | 149 |

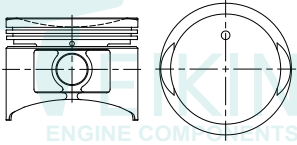
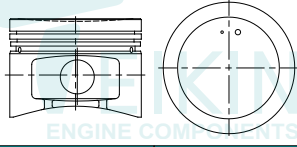

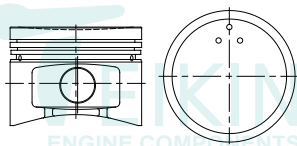

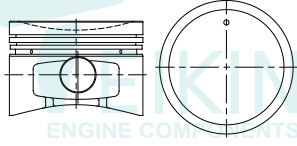

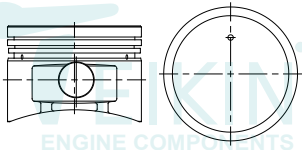

| ENGINE TYPE | PISTON | PISTON RING | PISTON PIN | PIN BUSHING | LINER | | LINER KIT SET |
|--|--|-------------------------------|--------------------------------|-------------|---------|-----------|---|
| | | | | | FLANGED | NO FLANGE | |
| MA10 987 cc 4 cyl.  Surface Treatment Bore Clearance Tin Coated MRC: 0.030 mm MP: 12.00 mm | \emptyset 68.00 -3.8 CD 26.5 TL 52.5 | 2 - 1.5 1 - 2.8 | \emptyset 17.000 TL 58.00 | | | | TEIKIN NO. REFERENCE NO. 12010-01B01/2/3 12010-24B02 1 |
| | TEIKIN NO. 44600 (44304) | TEIKIN NO. P 44600 | | | | | |
| | REFERENCE NO. 12010-01B01/2/3 12010-24B02 | | | | | | |
| | | | | | | | |
| MA10-II 987 cc 4 cyl.  Surface Treatment Bore Clearance Tin Coated MRC: 0.030 mm MP: 10.00 mm | \emptyset 68.00 -2.1 CD 26.5 TL 52.5 | 2 - 1.5 1 - 2.8 | \emptyset 17.000 TL 58.00 | | | | TEIKIN NO. REFERENCE NO. 12010-10B06 2 |
| | TEIKIN NO. 44650 (44319) | TEIKIN NO. P 44600 | | | | | |
| | REFERENCE NO. 12010-10B06 | | | | | | |
| | | | | | | | |
| CG10DE 998 cc 4 cyl. MICRA, MARCH 1993-2002 DOHC  Surface Treatment Bore Clearance Tin Coated MRC: 0.030 mm MP: 11.30 mm | \emptyset 71.00 CD 28.0 TL 52.1 | 1 - 1.2 1 - 1.5 1 - 3.0 | \emptyset 18.000 TL 53.00 | | | | TEIKIN NO. REFERENCE NO. 12010-99B20 3 |
| | TEIKIN NO. 44327 | TEIKIN NO. P 46332 | | | | | |
| | REFERENCE NO. 12010-99B20 | | | | | | |
| | | | | | | | |
| CG13DE 1275 cc 4 cyl. MICRA, MARCH 1993-2002 DOHC  Surface Treatment Bore Clearance Tin Coated MRC: 0.030 mm MP: 11.30 mm | \emptyset 71.00 -5.5 CD 28.0 TL 52.1 | 1 - 1.2 1 - 1.5 1 - 3.0 | \emptyset 18.000 TL 53.00 | | | | TEIKIN NO. REFERENCE NO. 12010-99B15 4 |
| | TEIKIN NO. 44326 | TEIKIN NO. P 46332 | | | | | |
| | REFERENCE NO. 12010-99B15 | | | | | | |
| | | | | | | | |

N

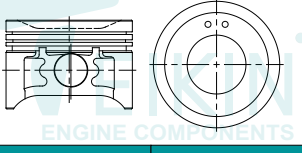
| ENGINE TYPE | PISTON | PISTON RING | PISTON PIN | PIN BUSHING | LINER | | LINER KIT SET | |
|--|--|-----------------------------------|---|-------------|---------|-----------|--|--|
| | | | | | FLANGED | NO FLANGE | | |
| CG13DE-II 1275 cc 4 cyl.  Surface Treatment Tin Coated Bore Clearance MRC: 0.030 mm MP: 8.50 mm | \emptyset 71.00 -5.5 CD 28.0 TL 49.5 | 1 - 1.2 1 - 1.5 1 - 3.0 | \emptyset 18.000 TL 58.00 | | | | TEIKIN NO. REFERENCE NO. 12010-41B01 12010-44B00 5 | |
| | TEIKIN NO. 44687 | | TEIKIN NO. P 46603 | | | | | |
| | | | | | | | | |
| | | | | | | | | |
| GA13 1295 cc 4 cyl.  Surface Treatment Tin Coated Bore Clearance MRC: 0.030 mm MP: 6.85 mm | \emptyset 71.00 -2.8 CD 32.6 TL 53.6 | 2 - 1.5 1 - 2.8 | \emptyset 19.000 TL 47.00  | | | | TEIKIN NO. REFERENCE NO. A2010-72Y00/01 6 | |
| | TEIKIN NO. 44609 (44301) | | TEIKIN NO. P 44609 | | | | | |
| | | | | | | | | |
| | | | | | | | | |
| A10 988 cc DATSUN 1000 4 cyl.  Surface Treatment Tin Coated Bore Clearance MRC: 0.030 mm MP: 20.00 mm | \emptyset 73.00 CD 32.5 TL 67.2 | 2 - 2.0 1 - 4.0 | \emptyset 17.450 TL 65.50 | | | | TEIKIN NO. REFERENCE NO. 12010-18021 12010-H2301 12010-H2361/62 7 | |
| | TEIKIN NO. 44256 | | TEIKIN NO. P 44256 | | | | | |
| | | | | | | | | |
| | | | | | | | | |
| A12 1970 1237 cc SUNNY, CHERRY PE 10 4 cyl. PULSAR 1200 TS  Surface Treatment Tin Coated Bore Clearance MRC: 0.030 mm MP: 20.10 mm | \emptyset 73.00 -1.5 CD 32.6 TL 67.4 | 2 - 2.0 1 - 4.0 | \emptyset 17.450 TL 65.50 | | | | TEIKIN NO. REFERENCE NO. 12010-H1001 12010-H1011 12010-H1061 8 | |
| | TEIKIN NO. 44102 | | TEIKIN NO. P 44256 | | | | | |
| | | | | | | | | |
| | | | | | | | | |

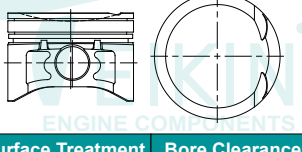

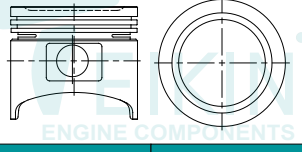

| ENGINE TYPE | PISTON | PISTON RING | PISTON PIN | PIN BUSHING | LINER | | LINER KIT SET |
|---|--|------------------------------|---|-------------|---------|-----------|-------------------|
| | | | | | FLANGED | NO FLANGE | |
| E10S, E10 980 cc 4 cyl.  | \emptyset 73.00 -5.4 CD 28.0 TL 57.0 | 2 - 1.5 1 - 4.0 | \emptyset 17.450 TL 62.00 | | | | TEIKIN NO. |
| Surface Treatment Tin Coated | Bore Clearance MRC: 0.030 mm MP: 14.50 mm | | | | | | |
| TEIKIN NO. 44122 | | TEIKIN NO. P 44122 | | | | | |
| REFERENCE NO. 12010-41M02 | | | | | | | |
| 9 | | | | | | | |
| GA14 1392 cc 4 cyl.  | \emptyset 73.60 -4.3 CD 32.6 TL 55.0 | 2 - 1.5 1 - 2.8 | \emptyset 19.000 TL 50.00  | | | | TEIKIN NO. |
| Surface Treatment Tin Coated | Bore Clearance MRC: 0.030 mm MP: 7.50 mm | | | | | | |
| TEIKIN NO. 44669 | | TEIKIN NO. P 48205 | | | | | |
| REFERENCE NO. A2010-73Y00 | | | | | | | |
| 10 | | | | | | | |
| GA14DS 1392 cc 4 cyl.  | \emptyset 73.60 -3.1 CD 32.5 TL 55.0 | 2 - 1.5 1 - 2.8 | \emptyset 19.000 TL 50.00  | | | | TEIKIN NO. |
| Surface Treatment Tin Coated | Bore Clearance MRC: 0.030 mm MP: 7.50 mm | | | | | | |
| TEIKIN NO. 44614 (44307) | | TEIKIN NO. P 48205 | | | | | |
| REFERENCE NO. 12010-87A61 | | | | | | | |
| 11 | | | | | | | |
| GA15DS 1497 cc 4 cyl.  | \emptyset 73.60 -4.8 CD 29.5 TL 51.9 | 2 - 1.5 1 - 2.8 | \emptyset 19.000 TL 50.00  | | | | TEIKIN NO. |
| Surface Treatment Tin Coated | Bore Clearance MRC: 0.030 mm MP: 7.50 mm | | | | | | |
| TEIKIN NO. 44610 (44302) | | TEIKIN NO. P 48205 | | | | | |
| REFERENCE NO. A2010-53Y00 A2010-53Y01 | | | | | | | |
| 12 | | | | | | | |

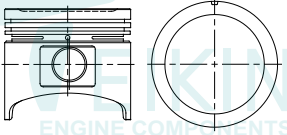
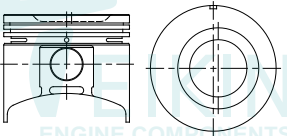
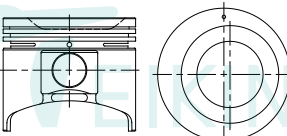
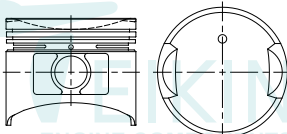
N

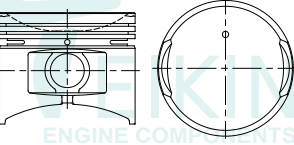
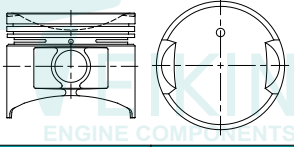
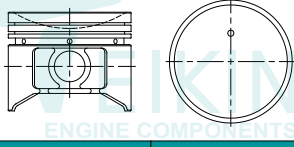
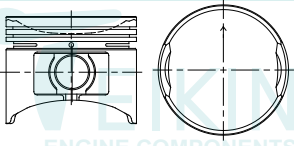
| ENGINE TYPE | PISTON | PISTON RING | PISTON PIN | PIN BUSHING | LINER | | LINER KIT SET | |
|--|--|------------------------|---|-------------|---------|-----------|--|----|
| | | | | | FLANGED | NO FLANGE | | |
| GA15DS-II 1497 cc 4 cyl.  ENGINE COMPONENTS Surface Treatment Bore Clearance Tin Coated MRC: 0.030 mm MP: 7.50 mm | \varnothing 73.60 -4.0 CD 29.5 TL 52.5 | 2 - 1.5 1 - 2.8 | \varnothing 19.000 TL 50.00  | | | | TEIKIN NO. TEIKIN NO. P 48205 REFERENCE NO. 12010-77A61 | 13 |
| | TEIKIN NO. 44337 | TEIKIN NO. P 48205 | | | | | | |
| | TEIKIN NO. | TEIKIN NO. | | | | | | |
| | TEIKIN NO. | TEIKIN NO. | | | | | | |
| QG15 1497 cc 4 cyl.  ENGINE COMPONENTS Surface Treatment Bore Clearance Tin Coated MRC: 0.030 mm MP: 10.00 mm | \varnothing 73.60 -4.8 CD 29.1 TL 51.6 | 2 - 1.5 1 - 2.8 | \varnothing 19.000 TL 49.00  | | | | TEIKIN NO. TEIKIN NO. P 44677 REFERENCE NO. 12010-7M600 | 14 |
| | TEIKIN NO. 44691 | TEIKIN NO. P 44677 | | | | | | |
| | TEIKIN NO. | TEIKIN NO. | | | | | | |
| | TEIKIN NO. | TEIKIN NO. | | | | | | |
| QG15DE 1497 cc 4 cyl. ALMERA N16E DOHC 16V 2002-  ENGINE COMPONENTS Surface Treatment Bore Clearance Anodized Crown MRC: 0.030 mm MP: 7.00 mm | \varnothing 73.60 -4.8 CD 29.2 TL 51.6 | 2 - 1.2 1 - 2.5 | \varnothing 19.000 TL 49.00  | | | | TEIKIN NO. TEIKIN NO. P 44677 REFERENCE NO. A2010-BN900 A2010-BN901 A2010-BN902 A2010-BN972 | 15 |
| | TEIKIN NO. 44677 | TEIKIN NO. P 44677 | | | | | | |
| | TEIKIN NO. | TEIKIN NO. | | | | | | |
| | TEIKIN NO. | TEIKIN NO. | | | | | | |
| A14-II 1397 cc 4 cyl.  ENGINE COMPONENTS Surface Treatment Bore Clearance Tin Coated MRC: 0.030 mm MP: 20.00 mm | \varnothing 76.00 -2.3 CD 32.5 TL 67.5 | 2 - 2.0 1 - 4.0 | \varnothing 19.000 TL 63.00  | | | | TEIKIN NO. TEIKIN NO. P 44322 REFERENCE NO. 12010-H7201 12010-H7211 12010-H7711 | 16 |
| | TEIKIN NO. 44322 | TEIKIN NO. P 44322 | | | | | | |
| | TEIKIN NO. | TEIKIN NO. | | | | | | |
| | TEIKIN NO. | TEIKIN NO. | | | | | | |

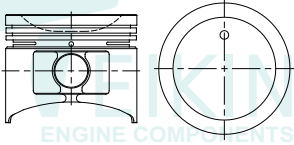
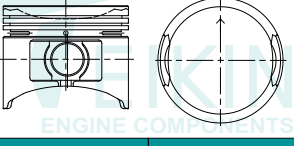
| ENGINE TYPE | PISTON | PISTON RING | PISTON PIN | PIN BUSHING | LINER | | LINER KIT SET |
|---|--|-------------------------------|--------------------------------|-------------|---------|-----------|---------------|
| | | | | | FLANGED | NO FLANGE | |
| A14S, A14 1397 cc 1978-81 SUNNY, CHERRY 4 cyl. | \emptyset 76.00 -1.1 CD 32.5 TL 67.4 | 2 - 2.0 1 - 4.0 | \emptyset 19.000 TL 64.00 | | | | TEIKIN NO. |
|  | TEIKIN NO. 44109 | | TEIKIN NO. P 43132 | | | | |
| Surface Treatment Bore Clearance Tin Coated MRC: 0.030 mm MP: 20.00 mm | REFERENCE NO. 12010-H7511 12010-H7521 12010-H7685 | | | | | | |
| | | | | | | | |
| A15-II 4 cyl. | \emptyset 76.00 -4.2 CD 30.0 TL 65.0 | 1 - 1.2 1 - 2.0 1 - 4.0 | \emptyset 19.000 TL 62.00 | | | | TEIKIN NO. |
|  | TEIKIN NO. 44324 | | TEIKIN NO. P 44259 | | | | |
| Surface Treatment Bore Clearance Tin Coated MRC: 0.030 mm MP: 19.00 mm | REFERENCE NO. 12010-H9802 | | | | | | |
| | | | | | | | |
| A15S, A15 1487 cc 1980 SUNNY CHERRY 4 cyl. | \emptyset 76.00 -6.5 CD 30.0 TL 64.9 | 1 - 1.2 1 - 2.0 1 - 4.0 | \emptyset 19.000 TL 64.00 | | | | TEIKIN NO. |
|  | TEIKIN NO. 44114 | | TEIKIN NO. P 43132 | | | | |
| Surface Treatment Bore Clearance Tin Coated MRC: 0.030 mm MP: 19.00 mm | REFERENCE NO. 12010-G3421 12010-H9261 12010-G3411 12010-G3462 | | | | | | |
| | | | | | | | |
| E13 1270 cc 4 cyl. | \emptyset 76.00 -7.0 CD 32.5 TL 62.5 | 2 - 1.5 1 - 4.0 | \emptyset 19.000 TL 62.00 | | | | TEIKIN NO. |
|  | TEIKIN NO. 44611 (44303) | | TEIKIN NO. P 44259 | | | | |
| Surface Treatment Bore Clearance Tin Coated MRC: 0.030 mm MP: 14.50 mm | REFERENCE NO. 12010-01M02 12010-01M12 12010-01M00 12010-01M22 | | | | | | |
| | | | | | | | |

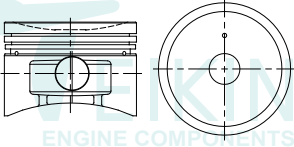
| ENGINE TYPE | PISTON | PISTON RING | PISTON PIN | PIN BUSHING | LINER | | LINER KIT SET |
|---|---|------------------------|----------------------------------|-------------|---------|-----------|----------------------|
| | | | | | FLANGED | NO FLANGE | |
| E15-III 1487 cc 4 cyl.  | \varnothing 76.00 -10.3 CD 32.5 TL 62.4 | 2 - 1.5 1 - 4.0 | \varnothing 19.000 TL 62.00 | | | | TEIKIN NO. 21 |
| | TEIKIN NO. 44355 | TEIKIN NO. P 44259 | | | | | |
| | REFERENCE NO. 12010-15M02 12010-15M22 | | | | | | |
| | Surface Treatment Bore Clearance Tin Coated MRC: 0.030 mm MP: 13.65 mm | | | | | | |
| E15S, E15 1487 cc 4 cyl. 1981  | \varnothing 76.00 -9.3 CD 31.8 TL 61.8 | 2 - 1.5 1 - 4.0 | \varnothing 19.000 TL 62.00 | | | | TEIKIN NO. 22 |
| | TEIKIN NO. 44125 | TEIKIN NO. P 44259 | | | | | |
| | REFERENCE NO. 12010-11M02 12010-19M02 12010-11M12 12010-11M22 | | | | | | |
| | Surface Treatment Bore Clearance Tin Coated MRC: 0.030 mm MP: 13.75 mm | | | | | | |
| E15-T 1487 cc 4 cyl.  | \varnothing 76.00 -10.0 CD 33.5 TL 61.0 | 2 - 1.5 1 - 4.0 | \varnothing 19.000 TL 62.00 | | | | TEIKIN NO. 23 |
| | TEIKIN NO. 44668 | TEIKIN NO. P 44259 | | | | | |
| | REFERENCE NO. 12010-17M12 | | | | | | |
| | Surface Treatment Bore Clearance Tin Coated MRC: 0.030 mm MP: 13.00 mm | | | | | | |
| E16 1597 cc 4 cyl. SENTRA 1.6 GEi, SGLi SENTRA 1.6 GL, GLX, GXE 1987-1990  | \varnothing 76.00 -10.0 CD 32.5 TL 62.5 | 2 - 1.5 1 - 4.0 | \varnothing 19.000 TL 62.00 | | | | TEIKIN NO. 24 |
| | TEIKIN NO. 44268 | TEIKIN NO. P 44259 | | | | | |
| | REFERENCE NO. | | | | | | |
| | Surface Treatment Bore Clearance Tin Coated MRC: 0.030 mm MP: 15.50 mm | | | | | | |

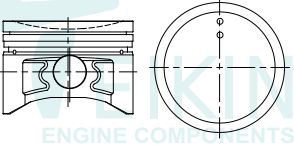
| ENGINE TYPE | PISTON | PISTON RING | PISTON PIN | PIN BUSHING | LINER | | LINER KIT SET |
|--|---|--------------------|--|-------------|---------|-----------|---------------|
| | | | | | FLANGED | NO FLANGE | |
| E16i 1597 cc 1987-88 PULSAR 1987-88 SENTRA CARB,SOHC, 8 V 4 cyl. | Ø 76.00 -9.7 CD 32.6 TL 62.6 | 2 - 1.5 1 - 4.0 | Ø 19.000 TL 52.00 | | | | TEIKIN NO. |
|  | TEIKIN NO. 44259 | | TEIKIN NO. P 44259 | | | | |
| Surface Treatment Bore Clearance Tin Coated MRC: 0.020 mm MP: 14.25 mm | REFERENCE NO. 12010-33M22 12010-31M02 12010-31M12 | | | | | | |
| | | | | | | 25 | |
| E16-T 1597 cc SENTRA 1.6 GEi, SGLi SENTRA 1.6 GL, GLX, GXE 1987-1990 4 cyl. | Ø 76.00 -8.0 CD 32.5 TL 62.5 | 2 - 1.5 1 - 4.0 | Ø 19.000 TL 62.00 | | | | TEIKIN NO. |
|  | TEIKIN NO. 44329 | | TEIKIN NO. P 44259 | | | | |
| Surface Treatment Bore Clearance Tin Coated MRC: 0.045 mm MP: 15.50 mm | REFERENCE NO. | | | | | | |
| | | | | | | 26 | |
| GA16DE 1597 cc SENTRA 200SZ NX F.I., DOHC 16V 1995-97 4 cyl. | Ø 76.00 -4.6 CD 29.5 TL 53.8 | 2 - 1.5 1 - 2.8 | Ø 19.000 TL 52.00  | | | | TEIKIN NO. |
|  | TEIKIN NO. 44260 | | TEIKIN NO. P 44258 | | | | |
| Surface Treatment Bore Clearance Tin Coated MRC: 0.030 mm MP: 9.50 mm | REFERENCE NO. A2010-74Y10 A2010-57Y00 | | | | | | |
| | | | | | | 27 | |
| GA16DE-II 1597 cc 1995-97 SENTRA, 200SX F.I., DOHC 4, 16 V 4 cyl. | Ø 76.00 -4.7 CD 29.7 TL 54.3 | 1 - 1.5 1 - 2.8 | Ø 19.000 TL 52.00  | | | | TEIKIN NO. |
|  | TEIKIN NO. 44270 | | TEIKIN NO. P 44258 | | | | |
| Surface Treatment Bore Clearance Anodized Crown MRC: 0.020 mm MP: 12.00 mm | REFERENCE NO. A2010-0M210 | | | | | | |
| | | | | | | 28 | |

| ENGINE TYPE | PISTON | PISTON RING | PISTON PIN | PIN BUSHING | LINER | | LINER KIT SET |
|---|---|--|--------------------------|-------------|---------|-----------|---------------|
| | | | | | FLANGED | NO FLANGE | |
| GA16DE-III GA16DS | 1596 cc 4 cyl. Ø 76.00 -4.2 CD 29.5 TL 54.0 | 2 - 1.5 1 - 3.0 | Ø 19.000 TL 55.00 | | | | TEIKIN NO. |
| ENGINE COMPONENTS | TEIKIN NO. 44695 | | TEIKIN NO. P 44695 | | | | |
| Surface Treatment Tin Coated | Bore Clearance MRC: 0.030 mm MP: 10.00 mm | REFERENCE NO. 12010-71J00/1/2 12010-71J10/11/12 12010-71J13/14/15 | | | | | 29 |
| GA16DS-II, GA16S | 1596 cc 4 cyl. Ø 76.00 -5.40 CD 29.5 TL 54.0 | 2 - 1.5 1 - 2.8 | Ø 19.000 TL 52.00 | | | | TEIKIN NO. |
| ENGINE COMPONENTS | TEIKIN NO. 44306 | | TEIKIN NO. P 44258 | | | | |
| Surface Treatment Tin Coated | Bore Clearance MRC: 0.030 mm MP: 9.50 mm | REFERENCE NO. 12010-94M61 12010-84A61 | | | | | 30 |
| GA16i, GA16DS PULSAR NX 12V SENTRA NX 12V 1989-90 F.I., SOHC 12 V | 1597 cc 4 cyl. Ø 76.00 -5.1 CD 29.6 TL 53.9 | 2 - 1.5 1 - 2.8 | Ø 19.000 TL 52.00 | | | | TEIKIN NO. |
| ENGINE COMPONENTS | TEIKIN NO. 44258 | | TEIKIN NO. P 44258 | | | | |
| Surface Treatment Tin Coated | Bore Clearance MRC: 0.020 mm MP: 9.50 mm | REFERENCE NO. A2010-74Y00 12010-54Y00 | | | | | 31 |
| QG16 | 1597 cc 4 cyl. Ø 76.00 -4.8 CD 29.1 TL 53.6 | 2 - 1.5 1 - 2.8 | Ø 19.000 TL 52.00 | | | | TEIKIN NO. |
| ENGINE COMPONENTS | TEIKIN NO. 44688 | | TEIKIN NO. P 44258 | | | | |
| Surface Treatment Tin Coated | Bore Clearance MRC: 0.030 mm MP: 9.50 mm | REFERENCE NO. 12010-D4011 A2010-8M510 | | | | | 32 |

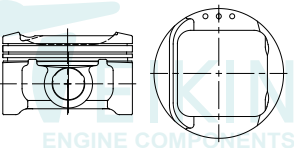
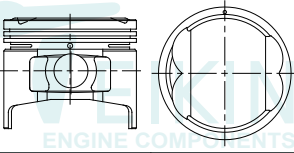
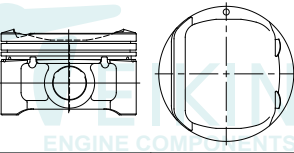
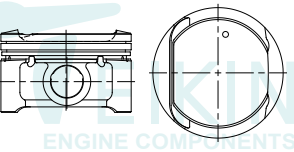
| ENGINE TYPE | PISTON | PISTON RING | PISTON PIN | PIN BUSHING | LINER | | LINER KIT SET |
|--|---|--------------------|---------------------|-------------|---------|-----------|---------------|
| | | | | | FLANGED | NO FLANGE | |
| HR12DE 1198 cc 3 cyl.  Surface Treatment: Moly Skirt, Anodized Crown, 1st Ring Anodized Bore Clearance: MRC: 0.030 mm, MP: 6.30 mm | Ø 78.00 +2.1 CD 28.9 TL 49.5 | 2 - 1.2 1 - 2.0 | Ø 19.00 TL 53.50 | | | | TEIKIN NO. |
| | TEIKIN NO. | | TEIKIN NO. | | | | |
| | 44351 | | P 44339 | | | | |
| | REFERENCE NO. | | | | | | |
| | 12010-1HC0A | | | | | | |
| | | | | | | | 37 |
| CA16 1598 cc 4 cyl. 1981 AUSTER FX STANZA FX  Surface Treatment: Tin Coated Bore Clearance: MRC: 0.030 mm, MP: 21.00 mm | Ø 78.00 +1.30 CD 30.0 TL 66.2 | 2 - 1.5 1 - 4.0 | Ø 20.00 TL 62.00 | | | | TEIKIN NO. |
| | TEIKIN NO. | | TEIKIN NO. | | | | |
| | 44186 | | P 38129 | | | | |
| | REFERENCE NO. | | | | | | |
| | 12010-D1101/10 12010-D1111 12010-06E01 12010-06E11 | | | | | | |
| | | | | | | | 38 |
| HR15DE 1500 cc 4 cyl. GRAND LEVINA, LEVINA XR LATTIO, TIIDA, NOTE, TONE 2004-  Surface Treatment: Anodized Crown, Moly Skirt Bore Clearance: MRC: 0.030 mm, MP: 5.40 mm | Ø 78.00 +2.00 CD 29.0 TL 49.4 | 2 - 1.2 1 - 2.0 | Ø 19.00 TL 53.50 | | | | TEIKIN NO. |
| | TEIKIN NO. | | TEIKIN NO. | | | | |
| | 44339 | | P 44339 | | | | |
| | REFERENCE NO. | | | | | | |
| | 12010-ED000 | | | | | | |
| | | | | | | | 39 |
| HR16DE 1600 cc 4 cyl.  Surface Treatment: Moly Skirt, Anodized Crown, 1st Ring Anodized Bore Clearance: MRC: 0.030 mm, MP: 5.40 mm | Ø 78.00 +2.1 CD 28.9 TL 49.4 | 2 - 1.2 1 - 2.0 | Ø 19.00 TL 53.50 | | | | TEIKIN NO. |
| | TEIKIN NO. | | TEIKIN NO. | | | | |
| | 44345 | | P 44339 | | | | |
| | REFERENCE NO. | | | | | | |
| | 12010-ED500 | | | | | | |
| | | | | | | | 40 |

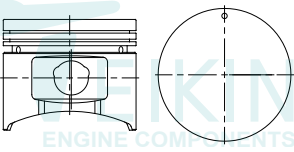
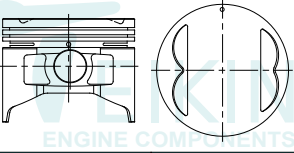
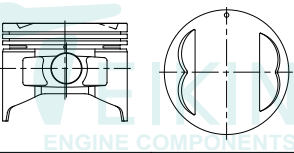
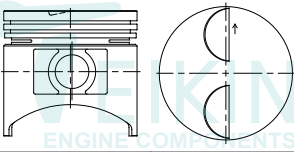

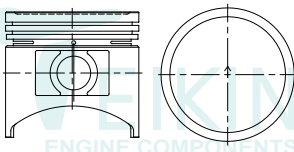
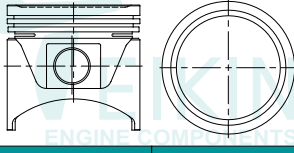
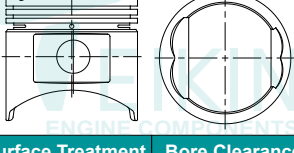
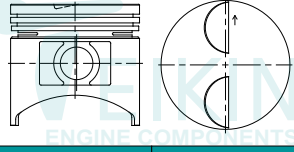
| ENGINE TYPE | PISTON | PISTON RING | PISTON PIN | PIN BUSHING | LINER | | LINER KIT SET |
|---|---|------------------------|-----------------------------|-------------|---------|-----------|---------------|
| | | | | | FLANGED | NO FLANGE | |
| NA16S 1600 cc 4 cyl.  Surface Treatment Tin Coated Bore Clearance MRC: 0.030 mm MP: 15.50 mm | Ø 81.50 CD 35.9 TL 68.0 | 2 - 1.5 1 - 4.0 | Ø 21.000 TL 63.50 | | | | TEIKIN NO. |
| | TEIKIN NO. 44615 (44310) | | TEIKIN NO. P 32120 | | | | |
| | REFERENCE NO. 12010-84G00 | | | | | | 45 |
| CA18 1809 cc 1981 4 cyl.  Surface Treatment Tin Coated Bore Clearance MRC: 0.030 mm MP: 20.50 mm | Ø 83.00 CD 30.0 TL 65.1 | 2 - 1.5 1 - 4.0 | Ø 20.000 TL 62.00 | | | | TEIKIN NO. |
| | TEIKIN NO. 44190 | | TEIKIN NO. P 38129 | | | | |
| | REFERENCE NO. 12010-D0301 12010-D1201 12010-01F01 12010-01F02 | | | | | | 46 |
| CA18ET 1809 cc 4 cyl.  Surface Treatment Tin Coated Bore Clearance MRC: 0.030 mm MP: 20.50 mm | Ø 83.00 CD 30.0 TL 65.0 | 2 - 1.5 1 - 2.8 | Ø 20.000 TL 61.00 | | | | TEIKIN NO. |
| | TEIKIN NO. 44661 | | TEIKIN NO. P 46310 | | | | |
| | REFERENCE NO. 12010-17F11 | | | | | | 47 |
| L16 2393 cc 1971-78 4 cyl. 240C, 2400 260C, 300C  Surface Treatment Tin Coated Bore Clearance MRC: 0.030 mm MP: 22.75 mm | Ø 83.00 CD 38.0 TL 78.0 | 2 - 2.0 1 - 4.0 | Ø 21.000 TL 72.50 | | | | TEIKIN NO. |
| | TEIKIN NO. 44160-4 | | TEIKIN NO. P 43155 | | | | |
| | REFERENCE NO. 12010-E3111 | | | | | | 48 |

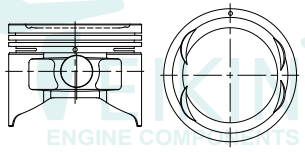
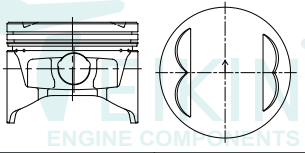
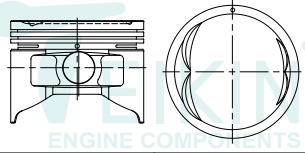
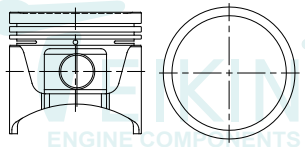
| ENGINE TYPE | PISTON | PISTON RING | PISTON PIN | PIN BUSHING | LINER | | LINER KIT SET | |
|---|--|------------------------|--------------------------------|-------------|---------|-----------|---------------|----|
| | | | | | FLANGED | NO FLANGE | | |
| L16-II/L26-II 1595 cc 4 cyl.  Surface Treatment Bore Clearance None MRC: 0.030 mm MP: 22.75 mm | \emptyset 83.00 -1.4 CD 38.0 TL 78.0 | 2 - 2.0 1 - 4.0 | \emptyset 21.000 TL 72.50 | | | | TEIKIN NO. | |
| | TEIKIN NO. | TEIKIN NO. | | | | | | |
| | 44283 | P 43155 | | | | | | |
| | REFERENCE NO. 12010-23002 12010-E3101 | | | | | | | 49 |
| L16-III 1595 cc 4 cyl.  Surface Treatment Bore Clearance Tin Coated MRC: 0.030 mm MP: 22.00 mm | \emptyset 83.00 -1.2 CD 38.2 TL 78.2 | 2 - 2.0 1 - 4.0 | \emptyset 21.000 TL 72.00 | | | | TEIKIN NO. | |
| | TEIKIN NO. | TEIKIN NO. | | | | | | |
| | 44662 | P 44662 | | | | | | |
| | REFERENCE NO. 12010-A9600 12010-A9601 12010-A9611 | | | | | | | 50 |
| Z16 1595 cc 4 cyl.  Surface Treatment Bore Clearance Tin Coated MRC: 0.030 mm MP: 21.25 mm | \emptyset 83.00 +0.6 CD 38.0 TL 78.9 | 2 - 2.0 1 - 4.0 | \emptyset 21.000 TL 66.00 | | | | TEIKIN NO. | |
| | TEIKIN NO. | TEIKIN NO. | | | | | | |
| | 44269 | P 44121 | | | | | | |
| | REFERENCE NO. 12010-W7111 12010-W7121 12010-W7161 | | | | | | | 51 |
| L24/L26 2393 cc 6 cyl. 1971-78 240C, 2400 260C, 300C  Surface Treatment Bore Clearance Tin Coated MRC: 0.030 mm MP: 22.75 mm | \emptyset 83.00 -2.9 CD 38.0 TL 78.0 | 2 - 2.0 1 - 4.0 | \emptyset 21.000 TL 72.50 | | | | TEIKIN NO. | |
| | TEIKIN NO. | TEIKIN NO. | | | | | | |
| | 44160 | P 43155 | | | | | | |
| | REFERENCE NO. 12010-E3111 | | | | | | | 52 |

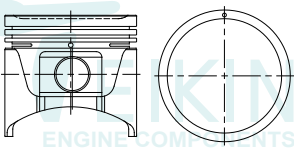
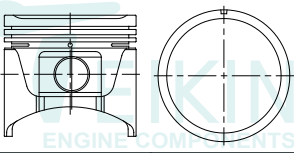
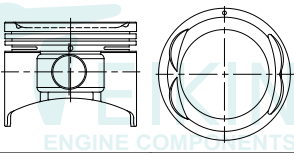
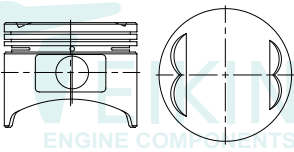

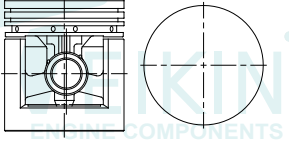
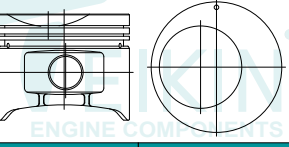
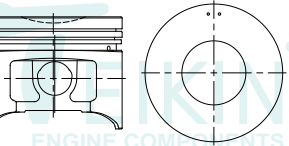
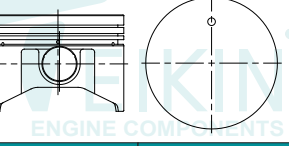

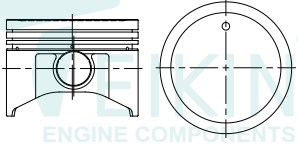
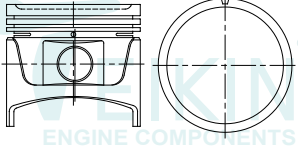
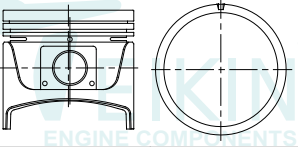
| ENGINE TYPE | PISTON | PISTON RING | PISTON PIN | PIN BUSHING | LINER | | LINER KIT SET |
|--|--|-----------------------|---------------------------------|-------------|---------|-----------|---------------|
| | | | | | FLANGED | NO FLANGE | |
| CA20 1974 cc SOHC, 8 V SKYLINE GL 1987-92 4 cyl. | \emptyset 84.50 -2.50 CD 30.0 TL 65.0 | 2 - 1.5 1 - 4.0 | \emptyset 20.000 TL 62.000 | | | | TEIKIN NO. |
|  | TEIKIN NO. 44193 | TEIKIN NO. P 38129 | | | | | |
| Surface Treatment Tin Coated Bore Clearance MRC: 0.030 mm MP: 20.00 mm | REFERENCE NO. 12010-04E11 12010-04F01/11 12010-10F01 | | | | | | |
| | | | | | | | |
| CA20-II 1973 cc 4 cyl. | \emptyset 84.50 -3.3 CD 30.0 TL 65.0 | 2 - 1.5 1 - 2.8 | \emptyset 20.000 TL 62.000 | | | | TEIKIN NO. |
|  | TEIKIN NO. 44279 | TEIKIN NO. P 38129 | | | | | |
| Surface Treatment Tin Coated Bore Clearance MRC: 0.030 mm MP: 19.60 mm | REFERENCE NO. 12010-13E11 | | | | | | |
| | | | | | | | |
| CA20-III 1974 cc 4 cyl. | \emptyset 84.50 -1.9 CD 30.1 TL 64.9 | 2 - 1.5 1 - 4.0 | \emptyset 20.000 TL 61.000 | | | | TEIKIN NO. |
|  | TEIKIN NO. 44663 | TEIKIN NO. P 46310 | | | | | |
| Surface Treatment Tin Coated Bore Clearance MRC: 0.030 mm MP: 20.00 mm | REFERENCE NO. 12010-D1800/01 12011-D1800/01 | | | | | | |
| | | | | | | | |
| L18 NEW 1970 P610TK, BLUEBIRD 1770 cc 4 cyl. | \emptyset 85.00 -0.7 CD 38.1 TL 78.4 | 2 - 2.0 1 - 4.0 | \emptyset 21.000 TL 72.500 | | | | TEIKIN NO. |
|  | TEIKIN NO. 44166 | TEIKIN NO. P 43155 | | | | | |
| Surface Treatment None Bore Clearance MRC: 0.030 mm MP: 22.40 mm | REFERENCE NO. 12010-A8701 12010-U2000 | | | | | | |
| | | | | | | | |

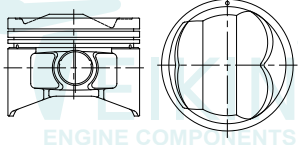
| ENGINE TYPE | PISTON | PISTON RING | PISTON PIN | PIN BUSHING | LINER | | LINER KIT SET |
|--|---|--------------------|-----------------------|-------------|---------|-----------|---------------|
| | | | | | FLANGED | NO FLANGE | |
| L18 OLD 1770 cc 1970 LAUREL, SILVIA BLUEBIRD 610 4 cyl. | Ø 85.00 -2.2 CD 38.1 TL 78.2 | 2 - 2.0 1 - 4.0 | Ø 21.000 TL 72.50 | | | | TEIKIN NO. |
|  | TEIKIN NO. 44167 | | TEIKIN NO. P 43155 | | | | |
| Surface Treatment Tin Coated Bore Clearance MRC: 0.030 mm MP: 22.40 mm | REFERENCE NO. 12010-A8711 12010-W0801 12010-W0811 | | | | | | 61 |
| L20B 1952 cc 4 cyl. | Ø 85.00 -2.2 CD 38.1 TL 78.1 | 2 - 2.0 1 - 4.0 | Ø 21.000 TL 72.50 | | | | TEIKIN NO. |
|  | TEIKIN NO. 44305 | | TEIKIN NO. P 43155 | | | | |
| Surface Treatment Tin Coated Bore Clearance MRC: 0.030 mm MP: 22.30 mm | REFERENCE NO. 12010-U6001 | | | | | | 62 |
| Z20 1952 cc 1981 4 cyl. | Ø 85.00 -3.5 CD 32.0 TL 67.0 | 2 - 1.5 1 - 4.0 | Ø 21.000 TL 72.50 | | | | TEIKIN NO. |
|  | TEIKIN NO. 44224 | | TEIKIN NO. P 43155 | | | | |
| Surface Treatment Tin Coated Bore Clearance MRC: 0.030 mm MP: 20.00 mm | REFERENCE NO. 12010-W1411 12010-W1421 12010-W1461 | | | | | | 63 |
| Z20S 1952 cc 1980 SOHC, 8 V 4 cyl. | Ø 85.00 -3.0 CD 31.9 TL 67.0 | 2 - 1.5 1 - 4.0 | Ø 21.000 TL 72.50 | | | | TEIKIN NO. |
|  | TEIKIN NO. 44227 | | TEIKIN NO. P 43155 | | | | |
| Surface Treatment None Bore Clearance MRC: 0.030 mm MP: 20.20 mm | REFERENCE NO. 12010-N8711 12010-N8721 | | | | | | 64 |

| ENGINE TYPE | PISTON | PISTON RING | PISTON PIN | PIN BUSHING | LINER | | LINER KIT SET |
|--|--|--------------------|--------------------------------|-------------|---------|-----------|---------------|
| | | | | | FLANGED | NO FLANGE | |
| P680 4000 cc 1965 PATROL TRK 5T, 6T 6 cyl. | \emptyset 85.73 CD 53.3 TL 94.5 | 2 - 2.5 1 - 4.8 | \emptyset 20.650 TL 74.00 | | | | TEIKIN NO. |
|  | TEIKIN NO. 44235 | | TEIKIN NO. P 44235 | | | | |
| Surface Treatment Tin Coated Bore Clearance MRC: 0.060 mm MP: 8.50 mm | REFERENCE NO. 12010-58100 12010-80000 12010-C8010 12010-58000 | | | | | | 65 |
| NA20 1998 cc 4 cyl. | \emptyset 86.00 CD 38.4 TL 69.9 -8.2 | 2 - 1.5 1 - 4.0 | \emptyset 21.000 TL 63.50 | | | | TEIKIN NO. |
|  | TEIKIN NO. 44604 (44293) | | TEIKIN NO. P 32120 | | | | |
| Surface Treatment Tin Coated Bore Clearance MRC: 0.030 mm MP: 13.50 mm | REFERENCE NO. 12010-85G00 12010-85G72 | | | | | | 66 |
| NA 20-II 4 cyl. | \emptyset 86.00 CD 38.5 TL 70.0 -3.9 | 2 - 1.5 1 - 4.0 | \emptyset 21.000 TL 63.50 | | | | TEIKIN NO. |
|  | TEIKIN NO. 44352 | | TEIKIN NO. P 32120 | | | | |
| Surface Treatment None Bore Clearance MRC: 0.030 mm MP: 14.00 mm | REFERENCE NO. | | | | | | 67 |
| SR20DE 1998 cc 4 cyl. | \emptyset 86.00 CD 32.0 TL 63.0 | 2 - 1.5 1 - 3.0 | \emptyset 22.000 TL 60.00 | | | | TEIKIN NO. |
|  | TEIKIN NO. 44601 (44309) | | TEIKIN NO. P 34102 | | | | |
| Surface Treatment Tin Coated Bore Clearance MRC: 0.030 mm MP: 17.00 mm | REFERENCE NO. A2010-65J02 A2010-65J01 | | | | | | 68 |

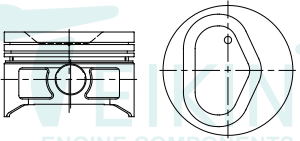
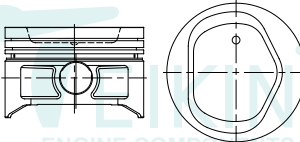
| ENGINE TYPE | PISTON | PISTON RING | PISTON PIN | PIN BUSHING | LINER | | LINER KIT SET |
|---|---|-------------------------------|---|-------------|---------|-----------|---------------|
| | | | | | FLANGED | NO FLANGE | |
| SR20DE-II 1998 cc 4 cyl. SENTRA 200SX/NX 1991-99 | \emptyset 86.00 -0.8 CD 32.0 TL 63.0 | 2 - 1.5 1 - 3.0 | \emptyset 22.000 TL 60.00  | | | | TEIKIN NO. |
|  | TEIKIN NO. 44652 | | TEIKIN NO. P 34102 | | | | |
| Surface Treatment Bore Clearance Tin Coated MRC: 0.030 mm MP: 17.00 mm | REFERENCE NO. A2010-63J00 12011-65J00 | | | | | | 69 |
| L28 2753 cc 6 cyl. | \emptyset 86.00 -3.0 CD 38.3 TL 78.3 | 2 - 2.0 1 - 4.0 | \emptyset 21.000 TL 72.50 | | | | TEIKIN NO. |
|  | TEIKIN NO. 44616 (44311) | | TEIKIN NO. P 43155 | | | | |
| Surface Treatment Bore Clearance Tin Coated MRC: 0.030 mm MP: 23.00 mm | REFERENCE NO. 12010-Y4111 12010-Y4121 12010-Y4131 | | | | | | 70 |
| L28S 2753 cc 6 cyl. | \emptyset 86.00 -2.2 CD 38.0 TL 78.2 | 1 - 1.5 1 - 2.0 1 - 4.0 | \emptyset 21.000 TL 72.50 | | | | TEIKIN NO. |
|  | TEIKIN NO. 44335 | | TEIKIN NO. P 43155 | | | | |
| Surface Treatment Bore Clearance Tin Coated MRC: 0.030 mm MP: 23.00 mm | REFERENCE NO. 12010-C6412 12010-C6421 | | | | | | 71 |
| RB30E 2962 cc 6 cyl. | \emptyset 86.00 +2.5 CD 32.5 TL 66.5 | 2 - 1.5 1 - 2.8 | \emptyset 20.990 TL 64.00  | | | | TEIKIN NO. |
|  | TEIKIN NO. 44664 | | TEIKIN NO. P 44664 | | | | |
| Surface Treatment Bore Clearance Tin Coated MRC: 0.030 mm MP: 22.00 mm | REFERENCE NO. 12010-67S11 12010-67S21 A2010-67S21 | | | | | | 72 |

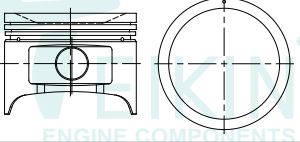
| ENGINE TYPE | PISTON | PISTON RING | PISTON PIN | PIN BUSHING | LINER | | LINER KIT SET |
|--|---|-------------------------------|--------------------------|-------------|---------|-----------|---------------|
| | | | | | FLANGED | NO FLANGE | |
| VG30i / VG30E OLD 2960 cc 1987-89 MAXIMA F.I., SOHC V6, 12 V 6 cyl. | Ø 87.00 -1.9 CD 32.0 TL 67.0 | 2 - 1.5 1 - 2.8 | Ø 20.980 TL 64.00 | | | | TEIKIN NO. |
| | TEIKIN NO. 44277 | | TEIKIN NO. P 44277 | | | | |
| Surface Treatment Tin Coated Bore Clearance MRC: 0.030 mm MP: 20.30 mm | REFERENCE NO. 12010-21P61 / 63 A2010-10G03 A2010-21P61 12010-V5901/10/11 | | | | | | 77 |
| VG30i-II 2960 cc 6 cyl. | Ø 87.00 -1.9 CD 32.0 TL 67.0 | 1 - 2.0 1 - 1.5 1 - 2.8 | Ø 20.980 TL 64.00 | | | | TEIKIN NO. |
| | TEIKIN NO. 44334 | | TEIKIN NO. P 44277 | | | | |
| Surface Treatment Tin Coated Bore Clearance MRC: 0.030 mm MP: 20.30 mm | REFERENCE NO. A2010-10G61 A2010-13G61 | | | | | | 78 |
| H20, H20P 1982 cc 1966 CEDRIC 4 cyl. | Ø 87.20 -1.6 CD 41.0 TL 84.0 | 1 - 2.0 1 - 2.5 1 - 4.0 | Ø 22.000 TL 72.60 | | | | TEIKIN NO. |
| | TEIKIN NO. 44196 | | TEIKIN NO. P 31116 | | | | |
| Surface Treatment Tin Coated Bore Clearance MRC: 0.030 mm MP: 23.00 mm | REFERENCE NO. 12010-74001 12010-R9001 | | | | | | 79 |
| H20-II 1982 cc 4 cyl. | Ø 87.20 -1.7 CD 41.0 TL 71.0 | 1 - 2.0 1 - 2.5 1 - 4.0 | Ø 20.000 TL 62.00 | | | | TEIKIN NO. |
| | TEIKIN NO. 44608 (44294) | | TEIKIN NO. P 38129 | | | | |
| Surface Treatment Tin Coated Bore Clearance MRC: 0.030 mm MP: 15.50 mm | REFERENCE NO. 12010-50K00 12010-50K24 | | | | | | 80 |

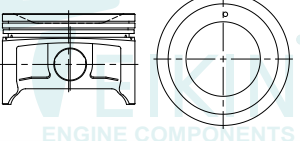
| ENGINE TYPE | PISTON | PISTON RING | PISTON PIN | PIN BUSHING | LINER | | LINER KIT SET |
|--|--|-----------------------|---|-------------|---------|-----------|---------------|
| | | | | | FLANGED | NO FLANGE | |
| K21 2065 cc FORKLIFT 4 cyl. | \emptyset 89.00 -7.7 CD 32.5 TL 58.0 | 2 - 1.5 1 - 2.8 | \emptyset 20.000 TL 57.00 | | | | TEIKIN NO. |
|  | TEIKIN NO. 44675 | TEIKIN NO. P 44675 | | | | | |
| Surface Treatment Bore Clearance None MRC: 0.030 mm MP: 10.00 mm | REFERENCE NO. 12010-FU422 | | | | | | |
| | | | | | | 81 | |
| K25 2488 cc FORKLIFT 4 cyl. | \emptyset 89.00 -9.9 CD 32.5 TL 58.0 | 2 - 1.5 1 - 2.8 | \emptyset 20.000 TL 57.00 | | | | TEIKIN NO. |
|  | TEIKIN NO. 44676 | TEIKIN NO. P 44675 | | | | | |
| Surface Treatment Bore Clearance None MRC: 0.030 mm MP: 10.00 mm | REFERENCE NO. 12010-FU522 | | | | | | |
| | | | | | | 82 | |
| KA24DE 2389 cc 4 cyl. | \emptyset 89.00 -6.6 CD 34.0 TL 68.3 | 2 - 1.5 1 - 2.8 | \emptyset 20.980 TL 60.00  | | | | TEIKIN NO. |
|  | TEIKIN NO. 44321 | TEIKIN NO. P 44274 | | | | | |
| Surface Treatment Bore Clearance Anodized Crown MRC: 0.020 mm MP: 17.00 mm | REFERENCE NO. A2010-53F00 A2010-1E400 | | | | | | |
| | | | | | | 83 | |
| KA24DE-IV 2389 cc 4 cyl. | \emptyset 89.00 -6.4 CD 34.0 TL 60.8 | 2 - 1.2 1 - 2.5 | \emptyset 20.990 TL 56.00  | | | | TEIKIN NO. |
|  | TEIKIN NO. 44338 | TEIKIN NO. P 44338 | | | | | |
| Surface Treatment Bore Clearance Anodized Crown Moly Skirt MRC: 0.030 mm MP: 13.00 mm | REFERENCE NO. A2010-5V110 A2010-9E000 A2010-5V112 | | | | | | |
| | | | | | | 84 | |

SUITABLE FOR



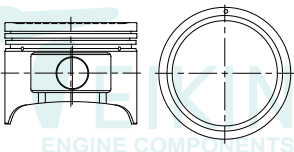
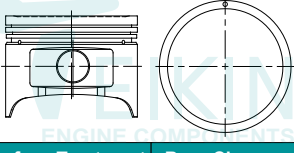
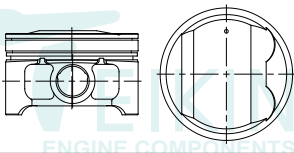
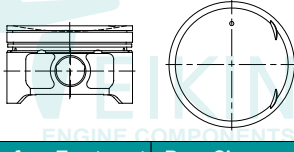

NISSAN

GASOLINE

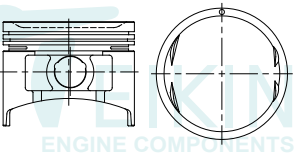
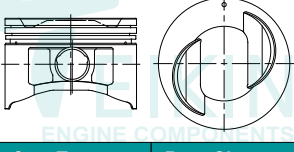

| ENGINE TYPE | PISTON | PISTON RING | PISTON PIN | PIN BUSHING | LINER | | LINER KIT SET |
|---|---|--------------------|--------------------------------|-------------|---------|-----------|---------------|
| | | | | | FLANGED | NO FLANGE | |
| KA24E 2388 cc F.I., SOHC, 12 V 4 cyl. | \emptyset 89.00 -0.70 CD 34.1 TL 68.4 | 2 - 1.5 1 - 2.8 | \emptyset 21.000 TL 66.00 | | | | TEIKIN NO. |
|  | TEIKIN NO. 44271 | | TEIKIN NO. P 44121 | | | | |
| Surface Treatment Tin Coated Bore Clearance MRC: 0.030 mm MP: 18.00 mm | REFERENCE NO. 12010-86G20 | | | | | | 85 |
| KA24E-II 2389 cc 4 cyl. | \emptyset 89.00 -0.5 CD 34.0 TL 68.2 | 2 - 1.5 1 - 2.8 | \emptyset 21.000 TL 61.50 | | | | TEIKIN NO. |
|  | TEIKIN NO. 44272 | | TEIKIN NO. P 56104 | | | | |
| Surface Treatment Anodized Crown Bore Clearance MRC: 0.020 mm MP: 17.00 mm | REFERENCE NO. 12010-40F10 A2010-30R10 A2010-30R12 | | | | | | 86 |
| QR20DE 1998 cc 4 cyl. | \emptyset 89.00 +1.9 CD 32.0 TL 56.5 | 2 - 1.2 1 - 2.5 | \emptyset 19.990 TL 59.00 | | | | TEIKIN NO. |
|  | TEIKIN NO. 44342 | | TEIKIN NO. P 44342 | | | | |
| Surface Treatment Anodized Crown Moly Skirt Bore Clearance MRC: 0.030 mm MP: 8.00 mm | REFERENCE NO. A2010-8H502 A2010-8H501 A2010-8H571 A2010-8H311/2 | | | | | | 87 |
| QR25DE 2488 cc X-TRAIL 2001 - ON SENTRA 2002 - ON 4 cyl. | \emptyset 89.00 -4.0 CD 32.0 TL 54.8 | 2 - 1.2 1 - 2.5 | \emptyset 19.990 TL 57.00 | | | | TEIKIN NO. |
|  | TEIKIN NO. 44328 | | TEIKIN NO. P 44328 | | | | |
| Surface Treatment Anodized Crown Moly Skirt Bore Clearance MRC: 0.030 mm MP: 9.50 mm | REFERENCE NO. A2010-9H576 A2010-9H511 A2010-9H512 A2010-8J011 | | | | | | 88 |

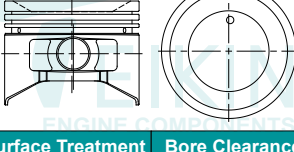
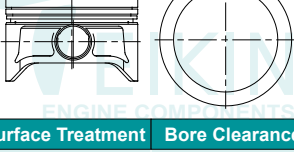
| ENGINE TYPE | PISTON | PISTON RING | PISTON PIN | PIN BUSHING | LINER | | LINER KIT SET |
|--|--|-------------------------------|------------------------------------|-------------|---------|-----------|---------------|
| | | | | | FLANGED | NO FLANGE | |
| QR25DE-III 2488 cc DOHC 16V FRONTIER 2005-2008 4 cyl. | \emptyset 89.00 +5.9 CD 32.9 TL 61.5 | 2 - 1.2 1 - 2.5 | \emptyset 19.990 TL 57.00 | | | | TEIKIN NO. |
| | TEIKIN NO. 44343 | | TEIKIN NO. P 44328 | | | | |
| Surface Treatment Bore Clearance Moly Skirt Anodized Crown 1st Ring Anodized MRC: 0.030 mm MP: 9.50 mm | REFERENCE NO. 12010-EA001 | | | | | | 89 |
| QR25DE-IV 2488 cc 4 cyl. | \emptyset 89.00 +4.1 CD 33.0 TL 58.2 | 2 - 1.2 1 - 2.0 | \emptyset 19.990 TL 57.00 | | | | TEIKIN NO. |
| | TEIKIN NO. 44349 | | TEIKIN NO. P 44328 | | | | |
| Surface Treatment Bore Clearance Moly Skirt Anodized Crown 1st Ring Anodized MRC: 0.030 mm MP: 7.00 mm | REFERENCE NO. A2010-JG31A | | | | | | 90 |
| QR25DE-V 4 cyl. | \emptyset 89.00 +3.3 CD 32.9 TL 57.3 | 2 - 1.2 1 - 2.0 | \emptyset 19.990 TL 57.00 | | | | TEIKIN NO. |
| | TEIKIN NO. 44353 | | TEIKIN NO. P 44328 | | | | |
| Surface Treatment Bore Clearance Moly Skirt Anodized Crown 1st Ring Anodized MRC: 0.030 mm MP: 7.00 mm | REFERENCE NO. A2010-ET81A | | | | | | 91 |
| Z24, Z24i 2389 cc PATHFINDER PICKUP, CARGOVAN F.I., SOHC, 8V 1983-89 4 cyl. | \emptyset 89.00 -4.0 CD 34.1 TL 70.6 | 1 - 2.0 1 - 1.5 1 - 4.0 | \emptyset 21.000 TL 66.00 | | | | TEIKIN NO. |
| | TEIKIN NO. 44232 | | TEIKIN NO. P 44121 | | | | |
| Surface Treatment Bore Clearance Tin Coated MRC: 0.030 mm MP: 20.40 mm | REFERENCE NO. 12010-83W01/2/3 12010-83W11/2/3 | | | | | | 92 |

| ENGINE TYPE | PISTON | PISTON RING | PISTON PIN | PIN BUSHING | LINER | | LINER KIT SET |
|--|---|-------------------------------|---|-------------|---------|-----------|--|
| | | | | | FLANGED | NO FLANGE | |
| Z24-II 2389 cc 4 cyl.  Surface Treatment Tin Coated Bore Clearance MRC: 0.030 mm MP: 20.40 mm | \emptyset 89.00 -4.0 CD 33.9 TL 70.5 | 2 - 1.5 1 - 4.0 | \emptyset 21.000 TL 66.00 | | | | TEIKIN NO. 93 |
| | TEIKIN NO. 44316 (44651) | TEIKIN NO. P 44121 | | | | | |
| | REFERENCE NO. 12010-30W01 12010-30W11 | | | | | | |
| VG33E 3300 cc 6 cyl. 1996-97 PATHFINDER F.I., SOHC V6, 12V  Surface Treatment Anodized Crown Bore Clearance MRC: 0.020 mm MP: 16.00 mm | \emptyset 91.50 -1.5 CD 32.0 TL 63.0 | 2 - 1.5 1 - 2.8 | \emptyset 20.980 TL 60.00  | | | | TEIKIN NO. 94 |
| | TEIKIN NO. 44274 | TEIKIN NO. P 44274 | | | | | |
| | REFERENCE NO. A2010-1W200 A2010-0W000 | | | | | | |
| H25 2472 cc 4 cyl. FORKLIFT D02S - J02 - J02S (93-00) SOHC 8V  Surface Treatment Tin Coated Bore Clearance MRC: 0.030 mm MP: 19.00 mm | \emptyset 92.00 -7.3 CD 36.0 TL 71.0 | 1 - 2.0 1 - 2.5 1 - 4.0 | \emptyset 21.000 TL 72.00 | | | | TEIKIN NO. 95 |
| | TEIKIN NO. 44699 | TEIKIN NO. P 44662 | | | | | |
| | REFERENCE NO. 12010-60K00 12010-60K70/1/2 | | | | | | |
| VQ30DE 2960 cc 6 cyl. 1995-97 MAXIMA F.I., DOHC V6, 24 V  Surface Treatment Tin Coated Anodized Crown Bore Clearance MRC: 0.020 mm MP: 13.80 mm | \emptyset 93.00 -0.5 CD 30.4 TL 58.2 | 2 - 1.2 1 - 2.5 | \emptyset 21.990 TL 58.00  | | | | TEIKIN NO. 96 |
| | TEIKIN NO. 44273 | TEIKIN NO. P 44273 | | | | | |
| | REFERENCE NO. A2010-39U00 A2010-38U10 A2010-38U71 | | | | | | |

| ENGINE TYPE | PISTON | PISTON RING | PISTON PIN | PIN BUSHING | LINER | | LINER KIT SET |
|--|---|------------------------|--------------------------------------|-------------|---------|-----------|---------------|
| | | | | | FLANGED | NO FLANGE | |
| VQ30DE-II 6 cyl. MAXIMA 2000-01 DOHC 24V | \varnothing 93.00 -0.50 CD 30.4 TL 58.0 | 2 - 1.2 1 - 2.5 | \varnothing 21.990 TL 58.00 | | | | TEIKIN NO. |
| | TEIKIN NO. | TEIKIN NO. | | | | | |
| Surface Treatment Bore Clearance Anodized Crown Moly Skirt MRC: 0.030 mm MP: 13.80 mm | 44325 | P 44273 | | | | | |
| REFERENCE NO. A2010-2Y900 | | | | | | | |
| VQ35DE 3498 cc 6 cyl. V6 3.5L DOHC 24V PATHFINDER 2001-2004 | \varnothing 95.50 CD 29.6 TL 52.7 | 2 - 1.2 1 - 2.5 | \varnothing 21.990 TL 58.00 | | | | TEIKIN NO. |
| | TEIKIN NO. | TEIKIN NO. | | | | | |
| Surface Treatment Bore Clearance Anodized Crown Moly Skirt MRC: 0.030 mm MP: 9.50 mm | 44332 | P 44273 | | | | | |
| REFERENCE NO. A2010-4W161 A2010-4W100/1/2 A2010-4W110/1/2 A2010-4W170/1/2 | | | | | | | |
| VQ35DE-II 3498 cc 6 cyl. 3.5L DOHC 24V ALTIMA 2002-2005 MAXIMA 2002-2005 MURANO 2003-2005 | \varnothing 95.50 +0.8 CD 29.6 TL 53.8 | 2 - 1.2 1 - 2.5 | \varnothing 21.990 TL 58.00 | | | | TEIKIN NO. |
| | TEIKIN NO. | TEIKIN NO. | | | | | |
| Surface Treatment Bore Clearance Anodized Crown Moly Skirt MRC: 0.030 mm MP: 9.50 mm | 44331 | P 44273 | | | | | |
| REFERENCE NO. A2010-8J101 | | | | | | | |
| VQ40DE 3954 cc 6 cyl. FRONTIER 05 PATHFINDER 05 XTERRA 05 V6 DOHC 24 V | \varnothing 95.50 -2.0 CD 31.6 TL 55.1 | 2 - 1.2 1 - 2.5 | \varnothing 21.990 TL 58.00 | | | | TEIKIN NO. |
| | TEIKIN NO. | TEIKIN NO. | | | | | |
| Surface Treatment Bore Clearance Anodized Crown Moly Skirt MRC: 0.030 mm MP: 10.00 mm | 44341 | P 44273 | | | | | |
| REFERENCE NO. 12010-EA200 | | | | | | | |







N



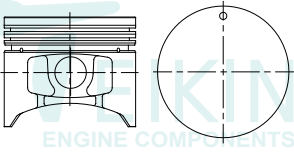

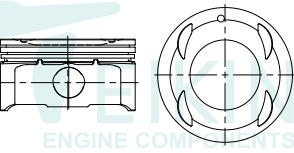

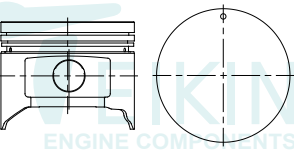

SUITABLE FOR

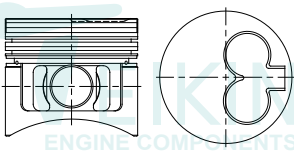
NISSAN

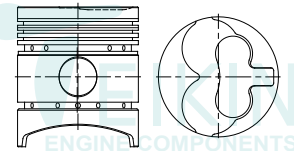

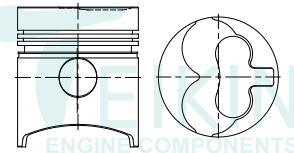

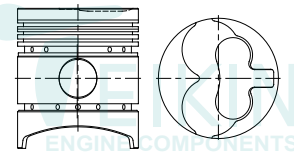



GASOLINE

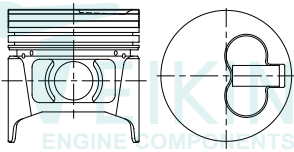

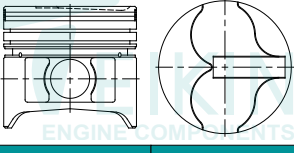
| ENGINE TYPE | PISTON | PISTON RING | PISTON PIN | PIN BUSHING | LINER | | LINER KIT SET |
|--|---|-------------------------------|---|-------------|---------|-----------|---|
| | | | | | FLANGED | NO FLANGE | |
| TB42/ E/ S 4169 cc 6 cyl.  Surface Treatment Tin Coated Bore Clearance MRC: 0.030 mm MP: 20.00 mm | \emptyset 96.00 CD 40.5 TL 80.0 | 2 - 2.0 1 - 4.0 | \emptyset 23.000 TL 76.00  | | | | TEIKIN NO. REFERENCE NO. 12010-03J61 101 |
| | TEIKIN NO. 44660 | TEIKIN NO. P 56105 | | | | | |
| | REFERENCE NO. 12010-03J61 | | | | | | |
| | | | | | | | |
| VK56DE 5552 cc 8 cyl.  Surface Treatment Anodized Crown Moly Skirt Bore Clearance MRC: 0.030 mm MP: 6.00 mm | \emptyset 98.00 CD 31.6 TL 52.0 | 2 - 1.5 1 - 2.5 | \emptyset 22.000 TL 60.0  | | | | TEIKIN NO. REFERENCE NO. 12010-7S000 12010-7S001/2 A2010-7S000/1/2 102 |
| | TEIKIN NO. 44680 | TEIKIN NO. P 34102 | | | | | |
| | REFERENCE NO. 12010-7S000 12010-7S001/2 A2010-7S000/1/2 | | | | | | |
| | | | | | | | |
| TB45DE/TB48DE 4500 cc 6 cyl.  Surface Treatment Anodized Crown 1st Ring Anodized Bore Clearance MRC: 0.030 mm MP: 20.00 mm | \emptyset 99.50 CD 40.3 TL 80.0 | 1 - 2.0 1 - 1.5 1 - 4.0 | \emptyset 22.990 TL 65.00  | | | | TEIKIN NO. REFERENCE NO. A2010-VB08B A2010-VC28B 103 |
| | TEIKIN NO. 44347 | TEIKIN NO. P 44347 | | | | | |
| | REFERENCE NO. A2010-VB08B A2010-VC28B | | | | | | |
| | | | | | | | |

| ENGINE TYPE | PISTON | PISTON RING | PISTON PIN | PIN BUSHING | LINER | | LINER KIT SET |
|---|---|--|---|---|---|---------------|---|
| | | | | | FLANGED | NO FLANGE | |
| CD17 1680 cc 4 cyl.  | \varnothing 80.00 CD 41.1 TL 71.1 -1.8 | 1 - 1.75 1 - 2.0 1 - 3.0 | \varnothing 24.000 TL 63.00  | | TL 146.0 OD 84.0 FT 4.8 FD 86.0 | 150.0 84.0 | TEIKIN NO. LKSF 44262 LKSX 44262 LKSF 44262A LKSX 44262A |
| | TEIKIN NO. 44262 44262A | TEIKIN NO. R 44262 | TEIKIN NO. P 44262 | TEIKIN NO. B 44262 | TEIKIN NO. LSF 44262 LSX 44262 | | |
| | REFERENCE NO. 12010-17A04 12010-17A02 12010-16A02 12010-71A02 | REFERENCE NO. 12033-16A00/10 12036-16A00/10 12038-16A00/10 | REFERENCE NO. 12030-16A00 12030-16A01 12030-16A02 | REFERENCE NO. 11012-16A00 | | | |
| | Surface Treatment Bore Clearance Tin Coated MRC: 0.030 mm MP: 12.70 mm | | | | | | |
| 104 | | | | | | | |
| SD22 2164 cc 4 cyl. CABSTAR 1977 CABAL, CLIPPER  | \varnothing 83.00 CD 48.0 TL 96.1 -2.0 | 1 - 2.5 2 - 2.0 2 - 4.5 | \varnothing 26.000 TL 71.00  | | TL 176.0 OD 87.0 FT 5.1 FD 93.0 | | TEIKIN NO. LKFF 44210 LKSF 44210 LKFF 44210A LKSF 44210A |
| | TEIKIN NO. 44210 44210A | TEIKIN NO. R 44210 | TEIKIN NO. P 44210 | TEIKIN NO. B 32102 | TEIKIN NO. LFF 44210 LSF 44210 | | |
| | REFERENCE NO. 12010-Y1411 12010-Y5210 12010-Y5211 12010-J5310 | REFERENCE NO. 12033-76202/3 12033-V1310 12033-Y1400/2 12033-Y1410/2 | REFERENCE NO. 90043-84001/4 90043-84018/50 90043-84057 90043-84105 | REFERENCE NO. 11012-76200 11012-76201 | | | |
| | Surface Treatment Bore Clearance Tin Coated MRC: 0.070 mm MP: 20.30 mm | | | | | | |
| 105 | | | | | | | |
| SD22-II 2164 cc 4 cyl.  | \varnothing 83.00 CD 48.0 TL 90.1 -2.1 | 1 - 2.5 1 - 2.0 1 - 4.5 | \varnothing 26.000 TL 71.00  | | TL 176.0 OD 87.0 FT 5.1 FD 93.0 | | TEIKIN NO. LKFF 44291 LKSF 44291 |
| | TEIKIN NO. 44291 | TEIKIN NO. R 44266 | TEIKIN NO. P 44210 | TEIKIN NO. B 44215 | TEIKIN NO. LFF 44210 LSF 44210 | | |
| | REFERENCE NO. 12010-36W10 12010-R8110 12010-R8111 | REFERENCE NO. 12033-02N00/1 12033-02N10/1 | REFERENCE NO. 12030-L2000 | REFERENCE NO. 11012-76200 11012-76201 | | | |
| | Surface Treatment Bore Clearance Tin Coated MRC: 0.070 mm MP: 20.30 mm | | | | | | |
| 106 | | | | | | | |
| SD33 3246 cc 6 cyl.  | \varnothing 83.00 CD 48.0 TL 96.1 -2.0 | 1 - 2.5 2 - 2.0 2 - 4.5 | \varnothing 26.000 TL 71.00  | | TL 176.0 OD 87.0 FT 5.0 FD 93.0 | | TEIKIN NO. LKFF 44210-6 LKSF 44210-6 LKFF 44210A-6 LKSF 44210A-6 |
| | TEIKIN NO. 44210-6 44210A-6 | TEIKIN NO. R 44210-6 | TEIKIN NO. P 44210 | TEIKIN NO. B 44603 | TEIKIN NO. LFF 44603 LSF 44603 | | |
| | REFERENCE NO. 12010-Y1411 12010-Y5210 12010-Y5211 12010-J5310 | REFERENCE NO. 12033-61500/2/3 12033-C6810/12 12033-J2200/1/2/4 | REFERENCE NO. 12030-37500 | REFERENCE NO. 11012-76200 11012-76201 11012-C8701 | | | |
| | Surface Treatment Bore Clearance Tin Coated MRC: 0.070 mm MP: 20.30 mm | | | | | | |
| 107 | | | | | | | |

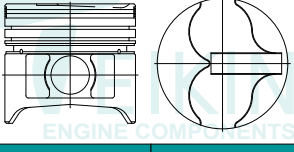
| ENGINE TYPE | PISTON | PISTON RING | PISTON PIN | PIN BUSHING | LINER | | LINER KIT SET |
|--|---|--|--|---|--|--|---|
| | | | | | FLANGED | NO FLANGE | |
| SD33T 3246 cc 6 cyl. | \emptyset 83.00 -2.0 CD 48.2 TL 80.2 | 1 - 2.5 HK 1 - 2.0 1 - 4.0 | \emptyset 26.000 TL 68.00 | | TL 176.0 OD 87.0 FT 5.0 FD 93.0 | | TEIKIN NO. LKFF 44603 LKSF 44603 LKFF 44603A LKSF 44603A |
| Surface Treatment Tin Coated | Bore Clearance MRC: 0.060 mm MP: 20.00 mm | TEIKIN NO. 44603 44603A (44282) | TEIKIN NO. R 44603 | TEIKIN NO. P 44603 | TEIKIN NO. B 44603 | TEIKIN NO. LFF 44603 LSF 44603 | 108 |
| | REFERENCE NO. 12010-C8701 12010-C8602 | REFERENCE NO. 12033-C8702 12033-C8704 | REFERENCE NO. 12030-37500 | REFERENCE NO. 11012-76200 11012-76201 11012-C8701 | | | |
| CD20 1973 cc 4 cyl. | \emptyset 84.50 -3.3 CD 44.3 TL 75.5 | 2 - 2.0 1 - 3.0 | \emptyset 25.000 TL 67.00 | | TL 148.0 OD 87.5 FT 4.8 FD 89.5 | 148.0 87.5 | |
| Surface Treatment Tin Coated | Bore Clearance MRC: 0.030 mm MP: 13.50 mm | TEIKIN NO. 44602 44602A (44280) | TEIKIN NO. R 44602 | TEIKIN NO. P 39157 | TEIKIN NO. B 44602 | TEIKIN NO. LSF 44602 LSX 44602 | 109 |
| | REFERENCE NO. A2010-57J01 12010-57J00 A2010-8E100 | REFERENCE NO. 12033-7J00 12035-57J00 12036-57J00 | REFERENCE NO. 12030-57J00 | REFERENCE NO. 11012-16A02 | | | |
| CD20-T 1973 cc 4 cyl. PRIMERA 1996-1999 | \emptyset 84.50 -2.6 CD 44.3 TL 75.6 | 1 - 2.0 HK 1 - 2.0 1 - 3.0 | \emptyset 28.000 TL 66.50 | | TL 148.0 OD 87.5 FT 4.8 FD 89.5 | 148.0 87.5 | |
| Surface Treatment Tin Coated Anodized Crown | Bore Clearance MRC: 0.030 mm MP: 14.00 mm | TEIKIN NO. 44681AG | TEIKIN NO. R 44681 | TEIKIN NO. P 44681 | TEIKIN NO. B 44681 | TEIKIN NO. LFX 44602 LSF 44602 LSX 44602 | 110 |
| | REFERENCE NO. A2010-1C310 A2010-2J600/2/3/4 A2010-2J671/2 | REFERENCE NO. 12033-1C300 12035-1C300 12036-1C300 | REFERENCE NO. 12030-1C300 | REFERENCE NO. 11012-16A02 | | | |
| LD28 2792 cc 6 cyl. | \emptyset 84.50 -3.1 CD 46.4 TL 86.4 | 2 - 2.0 1 - 4.0 | \emptyset 25.000 TL 67.00 | | TL 150.0 OD 88.5 FT 5.0 FD 90.0 | 150.0 88.5 | |
| Surface Treatment Tin Coated | Bore Clearance MRC: 0.030 mm MP: 22.50 mm | TEIKIN NO. 44625 44625A (44285) | TEIKIN NO. R 44625 | TEIKIN NO. P 39157 | TEIKIN NO. B 44625 | TEIKIN NO. LSF 44625 LSX 44625 | 111 |
| | REFERENCE NO. 12010-V0702 12010-V0762 12010-V5702 12010-V5756/62 | REFERENCE NO. 12033-60L00 12033-V0700 12036-60L00 12036-V0700 | REFERENCE NO. 12030-V0700 12030-V0701 | REFERENCE NO. 11012-V0700 | | | |







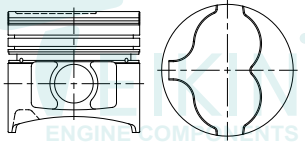

| ENGINE TYPE | PISTON | PISTON RING | PISTON PIN | PIN BUSHING | LINER | | | LINER KIT SET |
|--|---|---|---|--|--|---------------|---|---------------|
| | | | | | FLANGED | NO FLANGE | | |
| LD20 1952 cc 4 cyl.  | \varnothing 85.00 -3.1 CD 46.4 TL 86.3 | 2 - 2.0 1 - 4.0 | \varnothing 25.000 TL 67.00  | | TL 150.0 OD 89.0 FT 2.0 FD 93.0 | 150.0 89.0 | TEIKIN NO. LKSF 44176 LKSX 44176 LKSF 44176A LKSX 44176A | |
| | TEIKIN NO. 44176 44176A | TEIKIN NO. R 44176 | TEIKIN NO. P 39157 | TEIKIN NO. B 44176 | TEIKIN NO. LSF 44176 LSX 44176 | | | |
| | REFERENCE NO. 12010-18L02 12010-W1762 12010-W1702 | REFERENCE NO. 12033-35E25 12033-V7225 12033-W1700 12033-W3400 | | REFERENCE NO. 12030-V0700 12030-V0701 | REFERENCE NO. 11012-W1702 | | | |
| | Surface Treatment Bore Clearance Tin Coated MRC: 0.030 mm MP: 22.75 mm | | | | | | | |
| | | | | | | | | 112 |
| LD20-II 1952 cc 4 cyl.  | \varnothing 85.00 -2.6 CD 46.3 TL 77.8 | 2 - 2.0 1 - 4.0 | \varnothing 25.000 TL 67.00  | | TL 150.0 OD 89.0 FT 2.0 FD 93.0 | 150.0 89.0 | TEIKIN NO. LKSF 44263 LKSX 44263 LKSF 44263A LKSX 44263A | |
| | TEIKIN NO. 44263 44263A | TEIKIN NO. R 44176 | TEIKIN NO. P 39157 | TEIKIN NO. B 44176 | TEIKIN NO. LSF 44176 LSX 44176 | | | |
| | REFERENCE NO. 12010-G5502 12010-G5562 | REFERENCE NO. 12033-35E25 12033-V7225 12033-W1700 12033-W3400 | | REFERENCE NO. 12030-V0700 12030-V0701 | REFERENCE NO. 11012-W1702 | | | |
| | Surface Treatment Bore Clearance None MRC: 0.030 mm MP: 14.50 mm | | | | | | | |
| | | | | | | | | 113 |
| LD20-T 1952 cc 4 cyl.  | \varnothing 85.00 -3.5 CD 46.4 TL 72.6 | 2 - 2.0 1 - 4.0 | \varnothing 26.000 TL 66.00  | | TL 150.0 OD 89.0 FT 2.0 FD 93.0 | 150.0 89.0 | TEIKIN NO. LKSF 44624 LKSX 44624 LKSF 44624A LKSX 44624A LKSF 44624AG LKSX 44624AG | |
| | TEIKIN NO. 44624 44624A 44624AG (44284) | TEIKIN NO. R 44624 | TEIKIN NO. P G1113 | TEIKIN NO. B 44624 | TEIKIN NO. LSF 44176 LSX 44176 | | | |
| | REFERENCE NO. 12010-W3402 | REFERENCE NO. 12033-35E10 12033-W4200 12036-35E10 12036-W4200 | | REFERENCE NO. 12030-W3400 | REFERENCE NO. 11012-W1702 | | | |
| | Surface Treatment Bore Clearance Tin Coated MRC: 0.030 mm MP: 8.00 mm | | | | | | | |
| | | | | | | | | 114 |
| RD28 2825 cc 6 cyl.  | \varnothing 85.00 -2.8 CD 46.5 TL 78.0 | 2 - 2.0 1 - 4.0 | \varnothing 25.000 TL 67.00  | | TL 150.0 OD 89.0 FT 2.0 FD 93.0 | 150.0 89.0 | TEIKIN NO. LKSF 44606 LKSX 44606 LKFX 44606 | |
| | TEIKIN NO. 44606 (44289) | TEIKIN NO. R 44606 | TEIKIN NO. P 39157 | TEIKIN NO. B 44606 | TEIKIN NO. LSF 44606 LSX 44606 LFX 44606 | | | |
| | REFERENCE NO. 12010-V7213 A2010-V7213 | REFERENCE NO. 12033-20V01 12033-22J00/11/21 12033-35E00 12033-40L01/11 | | REFERENCE NO. 12030-V7200 | REFERENCE NO. 11012-V2070 | | | |
| | Surface Treatment Bore Clearance Tin Coated MRC: 0.030 mm MP: 14.50 mm | | | | | | | |
| | | | | | | | | 115 |

SUITABLE FOR

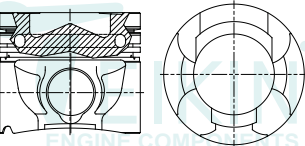

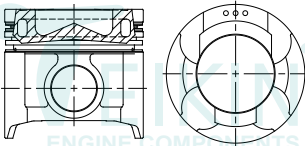

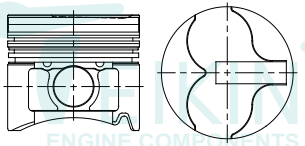



NISSAN

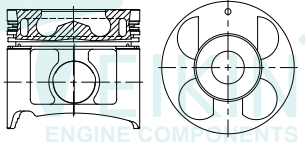

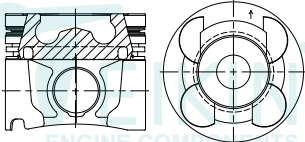

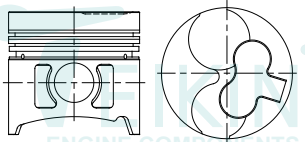

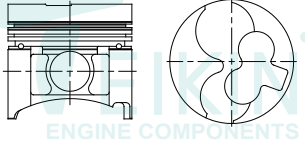

DIESEL

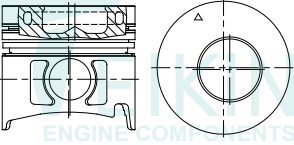

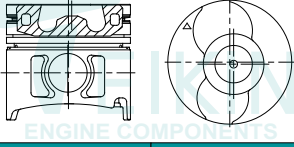

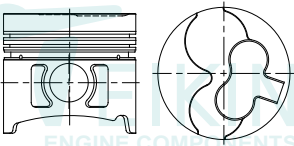

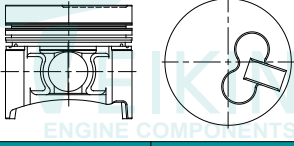

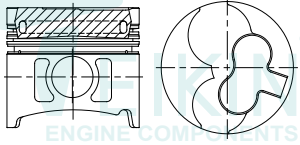

| ENGINE TYPE | PISTON | PISTON RING | PISTON PIN | PIN BUSHING | LINER | | | LINER KIT SET |
|---|---|---|---|-------------------------------------|---|---------------|---|---------------|
| | | | | | FLANGED | NO FLANGE | | |
| RD28-T 2825 cc 6 cyl.  | \emptyset 85.00 -2.8 CD 46.8 TL 78.3 | 2 - 2.0 1 - 4.0 | \emptyset 27.000 TL 67.00  | | TL 150.0 OD 89.0 FT 2.0 FD 93.0 | 150.0 89.0 | TEIKIN NO. LKSF 44623AG LKXS 44623AG 116 | |
| | TEIKIN NO. 44623AG (44281) | TEIKIN NO. R 44606 | TEIKIN NO. P 44623 | TEIKIN NO. B 44623 | TEIKIN NO. LSF 44606 LSX 44606 | | | |
| | REFERENCE NO. 12010-22J11 12010-22J62 12010-22J64 | REFERENCE NO. 12033-20V01 12033-22J00/11/21 12033-35E00 12033-40L01/11 | REFERENCE NO. 12030-22J01 | REFERENCE NO. 11012-V2070 | | | | |
| | Surface Treatment Bore Clearance Tin Coated MRC: 0.050 mm MP: 10.00 mm | | | | | | | |
| YD22DDT/DDTI 2184 cc 4 cyl.  | \emptyset 86.00 -15.2 CD 48.9 TL 73.8 | 1 - 2.0 HK 1 - 2.0 1 - 3.0 | \emptyset 28.000 TL 69.00  | | TL 160.0 OD 90.0 FT 5.0 FD 94.0 | 160.0 90.0 | TEIKIN NO. LKSF 44697AG LKXS 44697AG 117 | |
| | TEIKIN NO. 44697AG | TEIKIN NO. R 44697 | TEIKIN NO. P 44697 | TEIKIN NO. B 44671 | TEIKIN NO. LSF 44697 LSX 44697 | | | |
| | REFERENCE NO. A2010-AW400/1/2 A2010-AW471/2 | REFERENCE NO. 12033-AW400 12033-AU400 13033-8H800/10 12033-ES60A | REFERENCE NO. 12030-AD200 | REFERENCE NO. | | | | |
| | Surface Treatment Bore Clearance Moly Skirt MRC: 0.040 mm MP: 6.60 mm | | | | | | | |
| YD22DDT/ETI 2184 cc 4 cyl.  | \emptyset 86.00 -16.30 CD 49.0 TL 79.9 | 1 - 2.0 HK 1 - 2.0 1 - 3.0 | \emptyset 28.000 TL 61.50  | | TL 160.0 OD 90.0 FT 5.0 FD 94.0 | 160.0 90.0 | TEIKIN NO. LKSF 44685AG LKXS 44685AG 118 | |
| | TEIKIN NO. 44685AG | TEIKIN NO. R 44685 | TEIKIN NO. P 44685 | TEIKIN NO. B 44671 | TEIKIN NO. LSF 44685 LSX 44685 | | | |
| | REFERENCE NO. A2010-8H865 A2010-8H800/1/2 A2010-8H871/2 | REFERENCE NO. | REFERENCE NO. 12030-AD200 | REFERENCE NO. | | | | |
| | Surface Treatment Bore Clearance Moly Skirt MRC: 0.110 mm MP: 15.00 mm | | | | | | | |
| LD23 2283 cc 4 cyl.  | \emptyset 87.00 -2.2 CD 47.2 TL 76.2 | 2 - 2.0 1 - 3.0 | \emptyset 26.000 TL 62.70  | | TL 160.0 OD 91.0 FT 2.0 FD 95.0 | 160.0 91.0 | TEIKIN NO. LKSF 44295 LKXS 44295 LKSF 44295A LKXS 44295A 119 | |
| | TEIKIN NO. 44295 44295A | TEIKIN NO. R 44295 | TEIKIN NO. P 46270 | TEIKIN NO. B 44295 | TEIKIN NO. LSF 44295 LSX 44295 | | | |
| | REFERENCE NO. 12010-9C626 A2010-9C626 12010-9C600 12010-9C625 | REFERENCE NO. 12033-2J626 12033-9C625 12033-9C626 12035-9C626 | REFERENCE NO. 12030-9C600 | REFERENCE NO. | | | | |
| | Surface Treatment Bore Clearance None MRC: 0.030 mm MP: 10.50 mm | | | | | | | |

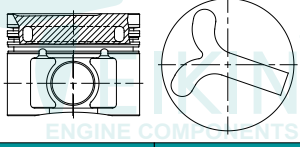
| ENGINE TYPE | PISTON | PISTON RING | PISTON PIN | PIN BUSHING | LINER | | LINER KIT SET |
|--|---|--|---|---|--|---------------|---|
| | | | | | FLANGED | NO FLANGE | |
| SD23 / SD25 1982 2289 cc 4 cyl. | \emptyset 89.00 -3.0 CD 48.0 TL 90.0 | 1 - 2.5 1 - 2.0 1 - 4.5 | \emptyset 26.000 TL 74.00 | | TL 172.0 OD 92.0 FT 5.0 FD 98.0 | | TEIKIN NO. LKFF 44215 LKSF 44215 LKFF 44215A LKSF 44215A |
| Surface Treatment Tin Coated Bore Clearance MRC: 0.080 mm MP: 21.50 mm | TEIKIN NO. 44215 44215A REFERENCE NO. 12010-09W01 12010-09W11 12010-L2002 2010-T6203/6/13/16/73 | TEIKIN NO. R 44215 REFERENCE NO. 12033-L2000/2/3/4/6 | TEIKIN NO. P 44215 REFERENCE NO. 12030-L2000 | TEIKIN NO. B 44215 REFERENCE NO. 12030-L2000 | TEIKIN NO. LFF 44215 LSF 44215 REFERENCE NO. 11012-L2002 11012-L2003 11012-L2004 | | 120 |
| SD23/25-II 2289 cc 4 cyl. | \emptyset 89.00 -1.8 CD 48.0 TL 80.0 | 1 - 2.5 1 - 2.0 1 - 4.5 | \emptyset 26.000 TL 74.00 | | TL 172.0 OD 92.0 FT 5.0 FD 98.0 | | TEIKIN NO. LKFF 44622 LKSF 44622 LKFF 44622A LKSF 44622A |
| Surface Treatment Tin Coated Bore Clearance MRC: 0.050 mm MP: 10.00 mm | TEIKIN NO. 44622 44622A (44308) REFERENCE NO. 12010-T6205 12010-T6206/2 12010-T7204/5 12010-T7206 | TEIKIN NO. R 44215 REFERENCE NO. 12033-L2000/2/3 12033-L2004/6 | TEIKIN NO. P 44215 REFERENCE NO. 12030-L2000 | TEIKIN NO. B 44215 REFERENCE NO. 12030-L2000 | TEIKIN NO. LFF 44215 LSF 44215 REFERENCE NO. 11012-L2002 11012-L2003 11012-L2004 | | 121 |
| TD23 2289 cc 4 cyl. | \emptyset 89.00 -1.6 CD 48.3 TL 84.1 | 1 - 2.5 1 - 2.0 1 - 4.0 | \emptyset 26.000 TL 74.00 | | TL 160.0 OD 92.0 FT 5.0 FD 98.0 | | TEIKIN NO. LKFF 44266 LKSF 44266 LKFF 44266A LKSF 44266A |
| Surface Treatment Tin Coated Bore Clearance MRC: 0.050 mm MP: 20.20 mm | TEIKIN NO. 44266 44266A REFERENCE NO. 12010-02N07 12010-02N06 12010-02N16 12010-02N17 | TEIKIN NO. R 44266 REFERENCE NO. 12033-02N00/1 12033-02N10/1 | TEIKIN NO. P 44215 REFERENCE NO. 12030-02N00 | TEIKIN NO. B 44266 REFERENCE NO. 12030-02N00 | TEIKIN NO. LFF 44266 LSF 44266 REFERENCE NO. 11012-02N00 11012-02N10 11012-02N17 | | 122 |
| YD25DDTI 4 cyl. | \emptyset 89.00 -17.30 CD 48.9 TL 73.8 | 1 - 2.0 HK 1 - 2.0 1 - 3.0 | \emptyset 28.000 TL 71.00 | | TL 167.0 OD 94.0 FT 4.0 FD 92.5 | 167.0 92.5 | TEIKIN NO. LKSF 44686AG LKSF 44686AG |
| Surface Treatment Moly Skirt Bore Clearance MRC: 0.030 mm MP: 6.00 mm | TEIKIN NO. 44686AG REFERENCE NO. A2010-EC00B | TEIKIN NO. R 44671 REFERENCE NO. | TEIKIN NO. P 44684 REFERENCE NO. | TEIKIN NO. B 44671 REFERENCE NO. 12030-AD200 | TEIKIN NO. LSF 44671 LSX 44671 REFERENCE NO. | | 123 |

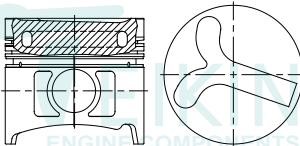
| ENGINE TYPE | PISTON | PISTON RING | PISTON PIN | PIN BUSHING | LINER | | | LINER KIT SET |
|--|---|---|---|--|---|------------------------|---|---------------|
| | | | | | FLANGED | NO FLANGE | | |
| YD25TDI 2488 cc 4 cyl.  Surface Treatment Bore Clearance Tin Coated MRC: 0.070 mm MP: 14.00 mm | \emptyset 89.00 -18.1 CD 48.8 TL 80.0 | 1 - 2.0 HK 1 - 2.0 1 - 3.0 | \emptyset 28.000 TL 61.00  | | TL 167.0 OD 94.0 FT 4.0 FD 92.5 | 157.0 92.5 | TEIKIN NO. LKSF 44671A LKXS 44671A LKSF 44671AG LKXS 44671AG | |
| | TEIKIN NO. 44671A 44671AG | TEIKIN NO. R 44671 | TEIKIN NO. P 44671 | TEIKIN NO. B 44671 | TEIKIN NO. LSF 44671 LSX 44671 | | | |
| | REFERENCE NO. A2010-VK510 A2010-VK515 A2010-VK516 | REFERENCE NO. 12033-VK500/10/20 12035-VK500/10/20 12036-VK500/10/20 A2033-VK510/20 | | REFERENCE NO. 12030-AD200 | REFERENCE NO. | | | |
| | | | | | | | 124 | |
| YD25TDI NEW 2488 cc 4 cyl.  Surface Treatment Bore Clearance Moly Skirt MRC: 0.030 mm MP: 6.00 mm | \emptyset 89.00 -19.20 CD 48.9 TL 73.8 | 1 - 2.0 HK 1 - 2.0 1 - 3.0 | \emptyset 28.000 TL 71.00  | | TL 167.0 OD 94.0 FT 4.0 FD 92.5 | 167.0 92.5 | TEIKIN NO. LKSF 44684AG LKXS 44684AG | |
| | TEIKIN NO. 44684AG | TEIKIN NO. R 44684 | TEIKIN NO. P 44684 | TEIKIN NO. B 44671 | TEIKIN NO. LSF 44671 LSX 44671 | | | |
| | REFERENCE NO. A2010-EB30A A2010-EB31A A2010-EB32A | REFERENCE NO. 12033-EB300 12033-EB30A/B 12035-EB300 12035-EB30A/B | | REFERENCE NO. 12030-AD200 | REFERENCE NO. | | | |
| | | | | | | | 125 | |
| TD25 2494 cc 4 cyl.  Surface Treatment Bore Clearance Tin Coated MRC: 0.050 mm MP: 18.00 mm | \emptyset 92.90 -1.5 CD 50.2 TL 87.0 | 1 - 2.5 1 - 2.0 1 - 4.0 | \emptyset 28.000 TL 80.00  | | TL 160.0 OD 95.9 FT 5.0 FD 102.0 | 160.0 95.9 102.0 | TEIKIN NO. LKFF 44255 LKSF 44255 LKFF 44255A LKSF 44255A | |
| | TEIKIN NO. 44255 44255A | TEIKIN NO. R 44255 | TEIKIN NO. P 44255 | TEIKIN NO. B 44255 | TEIKIN NO. LFF 44255 LSF 44255 | | | |
| | REFERENCE NO. 12010-44G02 12010-44G12 12010-44G01 | REFERENCE NO. 12033-44G10 A2033-44G00 | | REFERENCE NO. 12030-43G00 | REFERENCE NO. 11012-44G05 11012-44G10 11012-87G00 | | | |
| | | | | | | | 126 | |
| TD25 LATE 2494 cc 4 cyl.  Surface Treatment Bore Clearance Tin Coated MRC: 0.040 mm MP: 10.00 mm | \emptyset 92.90 -1.55 CD 50.3 TL 86.0 | 1 - 2.5 1 - 2.0 1 - 4.0 | \emptyset 30.000 TL 74.00  | | TL 160.0 OD 95.9 FT 5.0 FD 102.0 | 160.0 95.9 102.0 | TEIKIN NO. LKFF 44666A LKSF 44666A | |
| | TEIKIN NO. 44666A | TEIKIN NO. R 44255 | TEIKIN NO. P 44666 | TEIKIN NO. B 44296 | TEIKIN NO. LFF 44255 LSF 44255 | | | |
| | REFERENCE NO. 12010-44G15 | REFERENCE NO. 12033-44G10 A2033-44G00 | | REFERENCE NO. 12030-31N00 12030-G2400 | REFERENCE NO. 11012-44G05 11012-44G10 11012-87G00 | | | |
| | | | | | | | 127 | |

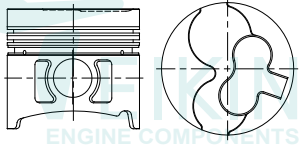
| ENGINE TYPE | PISTON | PISTON RING | PISTON PIN | PIN BUSHING | LINER | | LINER KIT SET |
|---|---|--|---|--|---|-----------|---|
| | | | | | FLANGED | NO FLANGE | |
| BD30 2953 cc 4 cyl.  | \emptyset 96.00 -20.0 CD 53.1 TL 89.5 | 1 - 2.5 1 - 2.0 1 - 4.0 | \emptyset 30.000 TL 79.80  | | TL 170.0 OD 99.0 FT 5.0 FD 105.0 | | TEIKIN NO. LKFF 44619 LKSF 44619 LKFF 44619AG LKSF 44619AG |
| | TEIKIN NO. 44619 44619AG (44318) | TEIKIN NO. R 44267 | TEIKIN NO. P 44296 | TEIKIN NO. B 44296 | TEIKIN NO. LFF 44619 LSF 44619 | | |
| | REFERENCE NO. 12010-54T00 12012-54T01 12010-54T10 | REFERENCE NO. 12033-43G10/1 12033-54T10/1 | REFERENCE NO. 12030-31N00 12030-G2400 | REFERENCE NO. 11012-54T00 | | | |
| | Surface Treatment Bore Clearance Tin Coated MRC: 0.030 mm MP: 17.00 mm | | | | | | |
| | | | | | | | 128 |
| BD30T 2953 cc 4 cyl.  | \emptyset 96.00 -21.2 CD 53.0 TL 89.5 | 1 - 2.5 HK 1 - 2.0 1 - 3.0 | \emptyset 30.000 TL 79.80  | | TL 170.0 OD 99.0 FT 5.0 FD 105.0 | | TEIKIN NO. LKFF 44654AG LKSF 44654AG |
| | TEIKIN NO. 44654AG | TEIKIN NO. R 44296 | TEIKIN NO. P 44296 | TEIKIN NO. B 44296 | TEIKIN NO. LFF 44619 LSF 44619 | | |
| | REFERENCE NO. 12010-69T05 12010-69T06 | REFERENCE NO. 12033-0W813/4 12033-0W81A 12033-2W211 12033-7F400 | REFERENCE NO. 12030-31N00 12030-G2400 | REFERENCE NO. 11012-54T00 | | | |
| | Surface Treatment Bore Clearance Tin Coated MRC: 0.030 mm MP: 17.50 mm | | | | | | |
| | | | | | | | 129 |
| TD27 2663 cc 4 cyl.  | \emptyset 96.00 -1.8 CD 50.2 TL 87.0 | 1 - 2.5 1 - 2.0 1 - 4.0 | \emptyset 28.000 TL 80.00  | | TL 160.0 OD 99.0 FT 4.0 FD 105.0 | | TEIKIN NO. LKFF 44267 LKSF 44267 LKFF 44267A LKSF 44267A |
| | TEIKIN NO. 44267 44267A | TEIKIN NO. R 44267 | TEIKIN NO. P 44255 | TEIKIN NO. B 44255 | TEIKIN NO. LFF 44267 LSF 44267 | | |
| | REFERENCE NO. 12010-10T02 12010-10T12 12010-43G02 12010-43G12 | REFERENCE NO. 12033-43G10/1 12033-54T10/1 | REFERENCE NO. 12030-43G00 | REFERENCE NO. 11012-2S000 11012-43G00 11012-43G05 11012-43G10 | | | |
| | Surface Treatment Bore Clearance Tin Coated MRC: 0.050 mm MP: 15.80 mm | | | | | | |
| | | | | | | | 130 |
| TD27-LATE 2663 cc 4 cyl.  | \emptyset 96.00 -1.8 CD 50.3 TL 86.0 | 1 - 2.5 1 - 2.0 1 - 3.0 | \emptyset 30.000 TL 74.00  | | TL 160.0 OD 99.0 FT 4.0 FD 105.0 | | TEIKIN NO. LKFF 44630 LKSF 44630 LKFF 44630A LKSF 44630A |
| | TEIKIN NO. 44630 44630A (44315) | TEIKIN NO. R 44630 | TEIKIN NO. P 44630 | TEIKIN NO. B 44296 | TEIKIN NO. LFF 44267 LSF 44267 | | |
| | REFERENCE NO. 12010-6T010 12010-6T000 | REFERENCE NO. 12033-6T010/1 | REFERENCE NO. 12030-31N00 12030-G2400 | REFERENCE NO. 11012-2S000 11012-43G00 11012-43G05 11012-43G10 | | | |
| | Surface Treatment Bore Clearance Tin Coated MRC: 0.040 mm MP: 16.00 mm | | | | | | |
| | | | | | | | 131 |

| ENGINE TYPE | PISTON | PISTON RING | PISTON PIN | PIN BUSHING | LINER | | | LINER KIT SET |
|---|---|----------------------------------|---|-------------------|----------------------|-------------------------------|-----------|---|
| | | | | | | FLANGED | NO FLANGE | |
| TD27-T 2663 cc 4 cyl.  Surface Treatment: Tin Coated Bore Clearance: MRC: 0.040 mm, MP: 16.25 mm | \emptyset 96.00 -1.7 CD 50.2 TL 87.0 | 1 - 2.5 HK 1 - 2.0 1 - 4.0 | \emptyset 30.000 TL 79.80  | | TL OD FT FD | 160.0 99.0 4.0 105.0 | | TEIKIN NO. LKFF 44621AG LKSF 44621AG (44292) REFERENCE NO. 12010-31N03 12010-05D00/10 12010-31N02/12/13 REFERENCE NO. 12033-31N11 12033-37N10 12033-63G10 REFERENCE NO. 12030-31N00 12030-G2400 REFERENCE NO. 11012-2S000 11012-43G00 11012-43G05 11012-43G10 |
| | TEIKIN NO. | TEIKIN NO. | TEIKIN NO. | TEIKIN NO. | TEIKIN NO. | | | |
| | TEIKIN NO. | TEIKIN NO. | TEIKIN NO. | TEIKIN NO. | TEIKIN NO. | | | |
| | TEIKIN NO. | TEIKIN NO. | TEIKIN NO. | TEIKIN NO. | TEIKIN NO. | | | |
| TD27-T-II 2663 cc 4 cyl.  Surface Treatment: Anodized Crown, Moly Skirt Bore Clearance: MRC: 0.030 mm, MP: 6.50 mm | \emptyset 96.00 -1.7 CD 50.5 TL 74.0 | 1 - 2.5 HK 1 - 2.0 1 - 3.0 | \emptyset 30.000 TL 79.80  | | TL OD FT FD | 160.0 99.0 4.0 105.0 | | TEIKIN NO. LKFF 44296 LKSF 44296 LKFF 44296A LKSF 44296A LKFF 44296AG LKSF 44296AG REFERENCE NO. 12010-7F406 A2010-7F406 A2010-7F407 A2010-7F408 REFERENCE NO. 12033-0W813/4 12033-0W81A 12033-2W211 12033-7F400 REFERENCE NO. 12030-31N00 12030-G2400 REFERENCE NO. 11012-2S000 11012-43G00 11012-43G05 11012-43G10 |
| | TEIKIN NO. | TEIKIN NO. | TEIKIN NO. | TEIKIN NO. | TEIKIN NO. | | | |
| | TEIKIN NO. | TEIKIN NO. | TEIKIN NO. | TEIKIN NO. | TEIKIN NO. | | | |
| | TEIKIN NO. | TEIKIN NO. | TEIKIN NO. | TEIKIN NO. | TEIKIN NO. | | | |
| TD27-T NEW 2664 cc 4 cyl.  Surface Treatment: Tin Coated Bore Clearance: MRC: 0.040 mm, MP: 16.25 mm | \emptyset 96.00 -2.2 CD 50.3 TL 87.0 | 1 - 2.5 HK 1 - 2.0 1 - 4.0 | \emptyset 30.000 TL 79.80  | | TL OD FT FD | 160.0 99.0 4.0 105.0 | | TEIKIN NO. LKFF 44674AG LKSF 44674AG REFERENCE NO. 12010-63G01 12010-63G11 REFERENCE NO. 12033-31N11 12033-37N10 12033-63G10 REFERENCE NO. 12030-31N00 12030-G2400 REFERENCE NO. 11012-2S000 11012-43G00 11012-43G05 11012-43G10 |
| | TEIKIN NO. | TEIKIN NO. | TEIKIN NO. | TEIKIN NO. | TEIKIN NO. | | | |
| | TEIKIN NO. | TEIKIN NO. | TEIKIN NO. | TEIKIN NO. | TEIKIN NO. | | | |
| | TEIKIN NO. | TEIKIN NO. | TEIKIN NO. | TEIKIN NO. | TEIKIN NO. | | | |
| TD42 2663 cc 6 cyl.  Surface Treatment: Tin Coated Bore Clearance: MRC: 0.050 mm, MP: 15.80 mm | \emptyset 96.00 -1.8 CD 50.2 TL 87.0 | 1 - 2.5 1 - 2.0 1 - 4.0 | \emptyset 28.000 TL 80.00  | | TL OD FT FD | 164.0 99.0 5.0 105.0 | | TEIKIN NO. LKFF 44267-6 LKSF 44267-6 LKFF 44267A-6 LKSF 44267A-6 REFERENCE NO. 12010-10T02 12010-10T12 12010-43G02 12010-43G12 REFERENCE NO. 12033-06J01 12033-06J10 12033-06J11 REFERENCE NO. 12030-43G00 REFERENCE NO. 11012-06J00 |
| | TEIKIN NO. | TEIKIN NO. | TEIKIN NO. | TEIKIN NO. | TEIKIN NO. | | | |
| | TEIKIN NO. | TEIKIN NO. | TEIKIN NO. | TEIKIN NO. | TEIKIN NO. | | | |
| | TEIKIN NO. | TEIKIN NO. | TEIKIN NO. | TEIKIN NO. | TEIKIN NO. | | | |

132







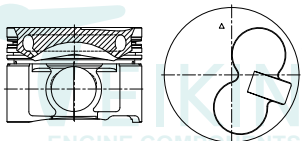

133

134

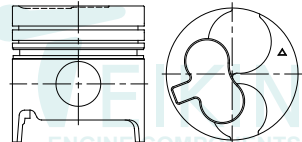
135

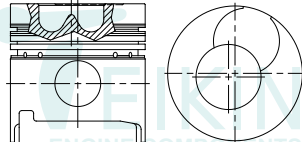
| ENGINE TYPE | PISTON | PISTON RING | PISTON PIN | PIN BUSHING | LINER | | | LINER KIT SET |
|--|---|--|--|-------------------------------------|---|----------------|---|---|
| | | | | | FLANGED | NO FLANGE | | |
| TD42-LATE 4169 cc 6 cyl. | \emptyset 96.00 -1.8 CD 50.3 TL 86.0 | 1 - 2.5 1 - 2.0 1 - 3.0 | \emptyset 30.000 TL 74.00 | | TL 164.0 OD 99.0 FT 5.0 FD 105.0 | | TEIKIN NO. LKFF 44630-6 LKSF 44630-6 LKFF 44630A-6 LKSF 44630A-6 | |
| Surface Treatment Tin Coated Bore Clearance MRC: 0.040 mm MP: 16.00 mm | TEIKIN NO. 44630-6 44630A-6 | TEIKIN NO. R 44630-6 | TEIKIN NO. P 44630 | TEIKIN NO. B 44630-6 | TEIKIN NO. LFF 44267-6 LSF 44267-6 | | 136 | |
| | REFERENCE NO. 12010-6T010 12010-6T000 | REFERENCE NO. 12033-06J15 | REFERENCE NO. 12030-31N00 | REFERENCE NO. 11012-06J00 | | | | |
| TD42-T 4169 cc 6 cyl. | \emptyset 96.00 -1.7 CD 50.2 TL 87.0 | 1 - 2.5 HK 1 - 2.0 1 - 4.0 | \emptyset 30.000 TL 79.80 | | TL 164.0 OD 99.0 FT 5.0 FD 105.0 | | | TEIKIN NO. LKFF 44621AG-6 LKSF 44621AG-6 |
| Surface Treatment Tin Coated Bore Clearance MRC: 0.040 mm MP: 16.25 mm | TEIKIN NO. 44621AG-6 (44292) | TEIKIN NO. R 44621-6 | TEIKIN NO. P 44296 | TEIKIN NO. B 44630-6 | TEIKIN NO. LFF 44267-6 LSF 44267-6 | | 137 | |
| | REFERENCE NO. 12010-31N03 12010-05D00 12010-05D10 | REFERENCE NO. 12033-05D01 | REFERENCE NO. 12030-31N00 | REFERENCE NO. 11012-06J00 | | | | |
| ZD30 2953 cc 4 cyl. TDI | \emptyset 96.00 -19.6 CD 50.1 TL 74.1 | 1 - 2.5 HK 1 - 2.0 1 - 3.0 | \emptyset 33.000 TL 78.00 | | TL 165.0 OD 100.0 FT 5.0 FD 104.0 | 160.0 100.0 | | TEIKIN NO. LKSF 44672AG LKXS 44672AG |
| Surface Treatment Tin Coated Anodized Crown Bore Clearance MRC: 0.030 mm MP: 12.00 mm | TEIKIN NO. 44672AG | TEIKIN NO. R 44296 | TEIKIN NO. P 44297 | TEIKIN NO. B 44297 | TEIKIN NO. LSF 44672 LSX 44672 | | 138 | |
| | REFERENCE NO. 12010-VD112 12010-VK600 | REFERENCE NO. 12033-0W813/4 12033-0W81A 12033-2W211 12033-7F400 | REFERENCE NO. 12030-1W400 12030-2W200 | REFERENCE NO. | | | | |
| ZD30 LATE 2953 cc 4 cyl. TDI | \emptyset 96.00 -19.6 CD 50.1 TL 74.1 | 1 - 2.5 HK 1 - 2.0 1 - 2.0 | \emptyset 33.000 TL 78.00 | | TL 165.0 OD 100.0 FT 5.0 FD 104.0 | 160.0 100.0 | | TEIKIN NO. LKSF 44673AG LKXS 44673AG |
| Surface Treatment Tin Coated Anodized Crown Bore Clearance MRC: 0.030 mm MP: 12.00 mm | TEIKIN NO. 44673AG | TEIKIN NO. R 44673 | TEIKIN NO. P 44297 | TEIKIN NO. B 44297 | TEIKIN NO. LSF 44672 LSX 44672 | | 139 | |
| | REFERENCE NO. 12010-VK610 | REFERENCE NO. 12033-DB010 12033-VK610 | REFERENCE NO. 12030-1W400 12030-2W200 | REFERENCE NO. | | | | |

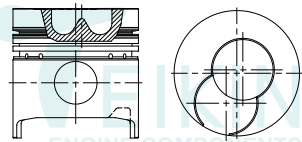
| ENGINE TYPE | PISTON | PISTON RING | PISTON PIN | PIN BUSHING | LINER | | | LINER KIT SET |
|--|---|---|--|--|---|----------------|---|---------------|
| | | | | | FLANGED | NO FLANGE | | |
| ZD30DD 2953 cc URVAN (E25) 4 cyl. | \emptyset 96.00 -18.2 CD 50.1 TL 74.1 | 1 - 2.0 1 - 1.2 1 - 2.0 | \emptyset 33.000 TL 78.00 | | TL 165.0 OD 100.0 FT 5.0 FD 104.0 | 160.0 100.0 | TEIKIN NO. LKSF 44702AG LKSF 44702AG LKSF 44672 LKSF 44672 LKSF 44672 LKSF 44672 LKSF 44672 LKSF 44672 | |
| | TEIKIN NO. 44702AG | TEIKIN NO. R 44685 | TEIKIN NO. P 44297 | TEIKIN NO. B 44297 | TEIKIN NO. LSX 44672 LSF 44672 | | | |
| | REFERENCE NO. 12010-VW200 12010-VW210 12010-VW211B | REFERENCE NO. 12033-VW211 | REFERENCE NO. 12030-1W400 12030-2W200 | REFERENCE NO. | | | | |
| | Surface Treatment Bore Clearance Tin Coated MRC: 0.030 mm MP: 5.00 mm | | | | | | | |
| 140 | | | | | | | | |
| ZD30DDTI 2953 cc CABSTAR PATROL F24M Y61 2006- 4 cyl. | \emptyset 96.00 -18.2 CD 50.1 TL 78.1 | 1 - 2.5 HK 1 - 2.0 1 - 2.0 | \emptyset 33.000 TL 78.00 | | TL 165.0 OD 100.0 FT 5.0 FD 104.0 | 160.0 100.0 | TEIKIN NO. LKSF 44678AG LKSF 44678AG LKSF 44672 LKSF 44672 LKSF 44672 LKSF 44672 | |
| | TEIKIN NO. 44678AG | TEIKIN NO. R 44673 | TEIKIN NO. P 44297 | TEIKIN NO. B 44297 | TEIKIN NO. LSF 44672 LSX 44672 | | | |
| | REFERENCE NO. 12010-DB000 12010-DB010 | REFERENCE NO. 12033-DB010 12033-VK610 | REFERENCE NO. 12030-1W400 12030-2W200 | REFERENCE NO. | | | | |
| | Surface Treatment Bore Clearance Tin Coated MRC: 0.050 mm MP: 8.50 mm | | | | | | | |
| 141 | | | | | | | | |
| ED30 2956 cc 4 cyl. | \emptyset 98.00 -1.5 CD 59.0 TL 103.0 | 1 - 3.0 2 - 2.0 1 - 4.5 | \emptyset 32.000 TL 85.00 | | TL 184.5 OD 111.0 FT 8.0 +0.9 FD 117.0 | | TEIKIN NO. LKFF 44670 LKFF 44670 LKFF 44670 LKFF 44670 | |
| | TEIKIN NO. 44670 | TEIKIN NO. R 44670 | TEIKIN NO. P 44670 | TEIKIN NO. B 44670 | TEIKIN NO. LFF 44670 | | | |
| | REFERENCE NO. 12010-J2000 12010-J2001 | REFERENCE NO. 12033-J2001/2/4 12033-J2006/8 97011-02139 | REFERENCE NO. 12030-J2000 | REFERENCE NO. 11012-J2000 11012-J2001 | | | | |
| | Surface Treatment Bore Clearance Tin Coated MRC: 0.110 mm MP: 10.00 mm | | | | | | | |
| 142 | | | | | | | | |
| QD32 3153 cc 4 cyl. | \emptyset 99.20 -2.4 CD 45.2 TL 69.9 | 1 - 2.5 1 - 2.0 1 - 3.0 | \emptyset 33.000 TL 78.00 | | TL 160.0 OD 103.2 FT 5.0 FD 107.0 | 155.0 103.2 | TEIKIN NO. LKSF 44297 LKSF 44297 LKSF 44297A LKSF 44297A | |
| | TEIKIN NO. 44297 44297A | TEIKIN NO. R 44297 | TEIKIN NO. P 44297 | TEIKIN NO. B 44297 | TEIKIN NO. LSF 44297 LSX 44297 | | | |
| | REFERENCE NO. 12010-2S605 | REFERENCE NO. 12033-2S610 | REFERENCE NO. 12030-1W400 12030-2W200 | REFERENCE NO. 11012-2S611 | | | | |
| | Surface Treatment Bore Clearance Tin Coated MRC: 0.050 mm MP: 5.00 mm | | | | | | | |
| 143 | | | | | | | | |

| ENGINE TYPE | PISTON | PISTON RING | PISTON PIN | PIN BUSHING | LINER | | LINER KIT SET |
|--|---|--|---|---|---|----------------|---|
| | | | | | FLANGED | NO FLANGE | |
| QD32TI 3153 cc 4 cyl.  Surface Treatment Tin Coated Bore Clearance MRC: 0.060 mm MP: 5.50 mm | \emptyset 99.20 -2.6 CD 45.3 TL 69.8 | 1 - 2.6 HK 1 - 2.0 1 - 3.0 | \emptyset 33.000 TL 79.00  | | TL 160.0 OD 103.2 FT 5.0 FD 107.0 | 155.0 103.2 | TEIKIN NO. LKFX 44683AG LKSF 44683AG LKXS 44683AG |
| | TEIKIN NO. | TEIKIN NO. | TEIKIN NO. | TEIKIN NO. | TEIKIN NO. | | |
| | 44683AG | R 44683 | P 44683 | B 44297 | LFX 44297 LSF 44297 LSX 44297 | | |
| | REFERENCE NO. | REFERENCE NO. | REFERENCE NO. | REFERENCE NO. | REFERENCE NO. | | |
| | 12010-2S615 | 12033-1W411 | 12030-1W400 12030-2W200 | 11012-2S611 | | | 144 |
| ED33 3298 cc 4 cyl.  Surface Treatment Tin Coated Bore Clearance MRC: 0.120 mm MP: 11.00 mm | \emptyset 100.00 -1.9 CD 59.0 TL 103.0 | 1 - 3.0 1 - 2.0 1 - 4.5 | \emptyset 34.000 TL 84.00  | | TL 191.0 OD 112.0 FT 8.0 +1.0 FD 118.0 | | TEIKIN NO. LKFF 44605 LKSF 44605 |
| | TEIKIN NO. | TEIKIN NO. | TEIKIN NO. | TEIKIN NO. | TEIKIN NO. | | |
| | 44605 (44286) | R 44605 | P 43617 | B 44605 | LFF 44605 LSF 44605 | | |
| | REFERENCE NO. | REFERENCE NO. | REFERENCE NO. | REFERENCE NO. | REFERENCE NO. | | |
| | 12010-J6500/1 12010-T9000/1 12010-T9010/20 | 12033-J6500/1 12033-J9000 12033-T9000 12033-Z5004 | 12030-Z5000 | 11012-T9000 11012-T9001 | | | 145 |
| FD33 3298 cc 4 cyl.  Surface Treatment Tin Coated Bore Clearance MRC: 0.120 mm MP: 22.50 mm | \emptyset 100.00 -20.9 CD 59.2 TL 103.2 | 1 - 3.0 1 - 2.0 1 - 4.5 | \emptyset 34.000 TL 85.00  | | TL 191.0 OD 113.0 FT 8.0 +1.0 FD 119.0 | | TEIKIN NO. LKFF 44698A |
| | TEIKIN NO. | TEIKIN NO. | TEIKIN NO. | TEIKIN NO. | TEIKIN NO. | | |
| | 44698A | R 44698 | P 44629 | B 44605 | LFF 44629 | | |
| | REFERENCE NO. | REFERENCE NO. | REFERENCE NO. | REFERENCE NO. | REFERENCE NO. | | |
| | 12010-T9313 12011-T9313 | 12033-J6500/1 12033-J9000 12033-T9000 12033-Z5004 | 12030-Z5000 | 11012-02T01 11012-02T10 11012-T9017 | | | 146 |
| FD33-T 3298 cc 4 cyl.  Surface Treatment Tin Coated Bore Clearance MRC: 0.120 mm MP: 15.00 mm | \emptyset 100.00 -20.9 CD 59.2 TL 103.2 | 1 - 3.1 HK 1 - 2.0 1 - 4.5 | \emptyset 34.000 TL 85.00  | | TL 191.0 OD 113.0 FT 8.0 +1.0 FD 119.0 | | TEIKIN NO. LKFF 44629A |
| | TEIKIN NO. | TEIKIN NO. | TEIKIN NO. | TEIKIN NO. | TEIKIN NO. | | |
| | 44629A (44313) | R 44629 | P 44629 | B 44605 | LFF 44629 | | |
| | REFERENCE NO. | REFERENCE NO. | REFERENCE NO. | REFERENCE NO. | REFERENCE NO. | | |
| | 12010-T9300 12010-T9310 | 12033-T9302 12033-T9307 12033-T9308 | 12030-Z5000 | 11012-02T01 11012-02T10 11012-T9017 | | | 147 |









N

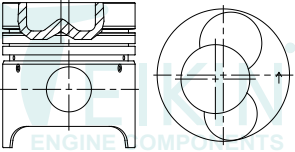

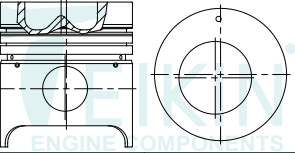

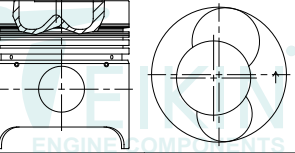

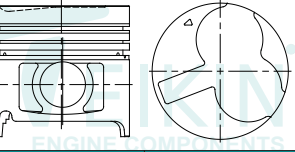

SUITABLE FOR

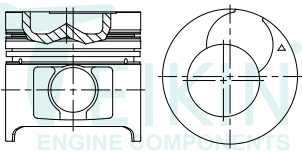

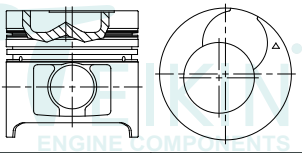

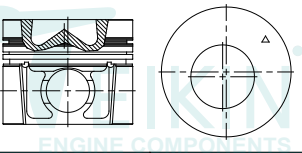

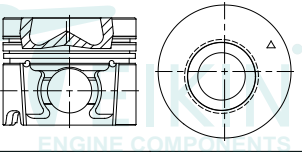

NISSAN

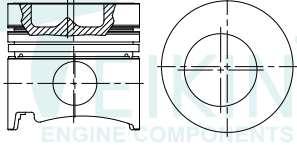

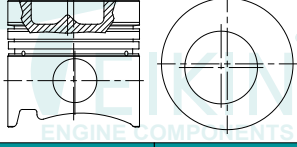

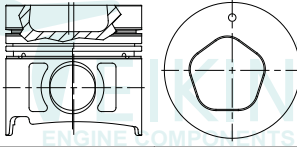

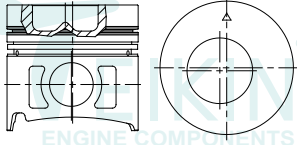

DIESEL

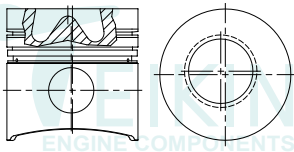

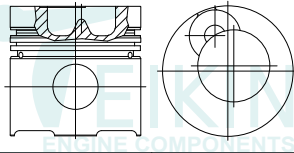

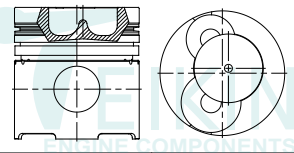
| ENGINE TYPE | PISTON | PISTON RING | PISTON PIN | PIN BUSHING | LINER | | LINER KIT SET |
|--|---|---|---|--|---|-----------|--|
| | | | | | FLANGED | NO FLANGE | |
| FD6T 5654 cc 6 cyl.  Surface Treatment Tin Coated Bore Clearance MRC: 0.130 mm MP: 21.75 mm | \emptyset 100.00 -21.7 CD 65.5 TL 109.5 | 1 - 3.0 HK 1 - 2.0 1 - 4.5 | \emptyset 34.000 TL 83.50  | | TL 212.0 OD 112.0 FT 8.1 +1.0 FD 118.0 | | TEIKIN NO. LKFF 44323 LKFF 44323A |
| | TEIKIN NO. 44323 44323A | TEIKIN NO. R 44323 | TEIKIN NO. P 39138 | TEIKIN NO. B 44323 | TEIKIN NO. LFF 44323 | | |
| | REFERENCE NO. 12011-Z5572 | REFERENCE NO. 12040-Z5528 | REFERENCE NO. 12030-Z5000 | REFERENCE NO. 11012-Z5001 11012-Z5020 11012-Z5508/9 11012-Z5512/6 | | | |
| | | | | | | | |
| | | | | | | | 148 |
| FD6T-II 5654 cc 6 cyl.  Surface Treatment Tin Coated Bore Clearance MRC: 0.120 mm MP: 21.75 mm | \emptyset 100.00 -18.7 CD 65.5 TL 109.5 | 1 - 3.0 HK 1 - 2.0 1 - 4.5 | \emptyset 34.000 TL 83.50  | | TL 212.0 OD 112.0 FT 8.1 +1.0 FD 118.0 | | TEIKIN NO. LKFF 44657A |
| | TEIKIN NO. 44657A | TEIKIN NO. R 44323 | TEIKIN NO. P 39138 | TEIKIN NO. B 44323 | TEIKIN NO. LFF 44323 | | |
| | REFERENCE NO. 12010-Z5600 | REFERENCE NO. 12040-Z5528 | REFERENCE NO. 12030-Z5000 | REFERENCE NO. 11012-Z5001 11012-Z5020 11012-Z5508/9 11012-Z5512/6 | | | |
| | | | | | | | |
| | | | | | | | 149 |
| FD6T-III 5654 cc 6 cyl.  Surface Treatment Tin Coated Bore Clearance MRC: 0.120 mm MP: 21.75 mm | \emptyset 100.00 -20.1 CD 65.5 TL 109.5 | 1 - 3.0 HK 2 - 2.0 1 - 4.5 | \emptyset 34.000 TL 83.50  | | TL 212.0 OD 112.0 FT 8.1 +1.0 FD 118.0 | | TEIKIN NO. LKFF 44658A |
| | TEIKIN NO. 44658A | TEIKIN NO. R 44658 | TEIKIN NO. P 39138 | TEIKIN NO. B 44323 | TEIKIN NO. LFF 44323 | | |
| | REFERENCE NO. 12011-Z5509 | REFERENCE NO. 12033-Z5502 12033-Z5527 12040-Z5527 | REFERENCE NO. 12030-Z5000 | REFERENCE NO. 11012-Z5001 11012-Z5020 11012-Z5508/9 11012-Z5512/6 | | | |
| | | | | | | | |
| | | | | | | | 150 |
| ED35 3465 cc 4 cyl.  Surface Treatment Tin Coated Bore Clearance MRC: 0.080 mm MP: 15.00 mm | \emptyset 102.50 -4.2 CD 59.0 TL 98.0 | 1 - 3.0 1 - 2.0 1 - 4.0 | \emptyset 34.000 TL 85.00  | | TL 191.0 OD 113.0 FT 8.0 +1.0 FD 119.0 | | TEIKIN NO. LKFF 44694A |
| | TEIKIN NO. 44694A | TEIKIN NO. R 44694 | TEIKIN NO. P 44629 | TEIKIN NO. B 44605 | TEIKIN NO. LFF 43620 | | |
| | REFERENCE NO. 12010-56T12 | REFERENCE NO. 12033-56T10 | REFERENCE NO. 12030-Z5000 | REFERENCE NO. 11012-01T01 | | | |
| | | | | | | | |
| | | | | | | | 151 |

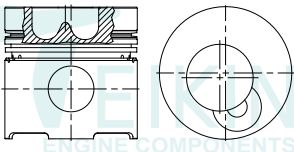
| ENGINE TYPE | PISTON | PISTON RING | PISTON PIN | PIN BUSHING | LINER | | LINER KIT SET |
|---|--|--|---|--|--|-----------|---|
| | | | | | FLANGED | NO FLANGE | |
| FD35 3465 cc 4 cyl.  Surface Treatment Tin Coated Bore Clearance MRC: 0.050 mm MP: 14.50 mm | \emptyset 102.50 -16.9 CD 59.2 TL 98.2 | 2 - 2.0 1 - 4.0 | \emptyset 34.000 TL 83.50  | | TL 191.0 OD 113.0 FT 8.0 +1.0 FD 119.0 | | TEIKIN NO. LKFF 44620 LKFF 44620A |
| | TEIKIN NO. 44620 44620A (44288) | TEIKIN NO. R 44620 | TEIKIN NO. P 39138 | TEIKIN NO. B 44605 | TEIKIN NO. LFF 44620 | | |
| | REFERENCE NO. 12010-01T04 | REFERENCE NO. 12033-01T10 | | REFERENCE NO. 12030-Z5000 | REFERENCE NO. 11012-01T01 | | |
| | | | | | | | 152 |
| FD35-T 3465 cc 4 cyl.  Surface Treatment Tin Coated Bore Clearance MRC: 0.060 mm MP: 15.00 mm | \emptyset 102.50 -16.4 CD 59.2 TL 98.2 | 1 - 3.0 HK 1 - 2.0 1 - 4.0 | \emptyset 34.000 TL 85.00  | | TL 191.0 OD 113.0 FT 8.0 +1.0 FD 119.0 | | TEIKIN NO. LKFF 44659 LKFF 44659A |
| | TEIKIN NO. 44659 44659A | TEIKIN NO. R 44659 | TEIKIN NO. P 44629 | TEIKIN NO. B 44605 | TEIKIN NO. LFF 44620 | | |
| | REFERENCE NO. 12010-01T03 | REFERENCE NO. 12033-01T60 | | REFERENCE NO. 12030-Z5000 | REFERENCE NO. 11012-01T01 | | |
| | | | | | | | 153 |
| FD42 4214 cc 4 cyl.  Surface Treatment Tin Coated Bore Clearance MRC: 0.070 mm MP: 8.00 mm | \emptyset 108.00 -21.6 CD 59.2 TL 87.1 | 1 - 3.0 1 - 2.0 1 - 4.0 | \emptyset 36.000 TL 93.00  | | TL 197.0 OD 111.0 FT 8.0 +0.9 FD 115.9 | | TEIKIN NO. LKFF 44665AG LKSF 44665AG |
| | TEIKIN NO. 44665AG | TEIKIN NO. R 44618 | TEIKIN NO. P 44665 | TEIKIN NO. B 44618 | TEIKIN NO. LFF 44665 LSF 44665 | | |
| | REFERENCE NO. 12010-0T016 | REFERENCE NO. 12033-0T000/10 12033-0T011/60 | | REFERENCE NO. 12030-0T000 12030-0T001 | REFERENCE NO. 11012-0T000 11012-0T001 | | |
| | | | | | | | 154 |
| FD46 4617 cc 4 cyl.  Surface Treatment Tin Coated Bore Clearance MRC: 0.080 mm MP: 9.00 mm | \emptyset 108.00 -22.2 CD 59.2 TL 87.1 | 1 - 3.0 1 - 2.0 1 - 4.0 | \emptyset 36.000 TL 92.50  | | TL 213.0 OD 111.0 FT 8.0 +1.0 FD 115.9 | | TEIKIN NO. LKFF 44618 LKSF 44618 LKFF 44618A LKSF 44618A |
| | TEIKIN NO. 44618 44618A (44314) | TEIKIN NO. R 44618 | TEIKIN NO. P 44261 | TEIKIN NO. B 44618 | TEIKIN NO. LFF 44618 LSF 44618 | | |
| | REFERENCE NO. 12010-0T302 12010-0T312 | REFERENCE NO. 12033-0T000/10 12033-0T011/60 | | REFERENCE NO. 12030-0T000 12030-0T001 | REFERENCE NO. 11012-0T300 | | |
| | | | | | | | 155 |

| ENGINE TYPE | PISTON | PISTON RING | PISTON PIN | PIN BUSHING | LINER | | LINER KIT SET |
|--|--|--|---|-------------------------------------|---|---|---------------|
| | | | | | FLANGED | NO FLANGE | |
| FE6 6925 cc 6 cyl.  Surface Treatment Bore Clearance Tin Coated MRC: 0.160 mm Anodized Crown MP: 10.00 mm | \emptyset 108.00 -19.4 CD 65.3 TL 103.5 | 1 - 3.0 1 - 2.0 1 - 4.0 | \emptyset 36.000 TL 92.00  | | TL 217.0 OD 111.0 FT 8.0 +0.9 FD 116.0 | TEIKIN NO. LKFF 44667A TEIKIN NO. 44667A R 44667 P 44667 B 44244 LFF 44261 REFERENCE NO. 12011-Z5615 12011-Z5801 REFERENCE NO. 12040-Z5211 12040-Z5504 12040-Z5511 REFERENCE NO. 12030-95000 12030-95001 REFERENCE NO. 11012-Z5518 | 156 |
| | TEIKIN NO. 44667A | TEIKIN NO. R 44667 | TEIKIN NO. P 44667 | TEIKIN NO. B 44244 | TEIKIN NO. LFF 44261 | | |
| | REFERENCE NO. 12011-Z5615 12011-Z5801 | REFERENCE NO. 12040-Z5211 12040-Z5504 12040-Z5511 | REFERENCE NO. 12030-95000 12030-95001 | REFERENCE NO. 11012-Z5518 | | | |
| | | | | | | | |
| FE6T 6925 cc 6 cyl. CKA87H  Surface Treatment Bore Clearance Anodized Crown MRC: 0.150 mm MP: 15.60 mm | \emptyset 108.00 -19.3 CD 65.5 TL 103.5 | 1 - 3.0 HK 1 - 2.0 1 - 4.0 | \emptyset 36.000 TL 92.50  | | TL 217.0 OD 111.0 FT 8.0 +0.9 FD 116.0 | TEIKIN NO. LKFF 44261 LKSF 44261 LKFF 44261A LKSF 44261A TEIKIN NO. 44261 44261A R 44261 P 44261 B 44244 LFF 44261 LSF 44261 REFERENCE NO. 12040-Z5502 12040-Z5512 12040-Z5517 REFERENCE NO. 12030-95000 12030-95001 REFERENCE NO. 11012-Z5518 | 157 |
| | TEIKIN NO. 44261 44261A | TEIKIN NO. R 44261 | TEIKIN NO. P 44261 | TEIKIN NO. B 44244 | TEIKIN NO. LFF 44261 LSF 44261 | | |
| | REFERENCE NO. 12040-Z5502 12040-Z5512 12040-Z5517 | REFERENCE NO. 12030-95000 12030-95001 | REFERENCE NO. 11012-Z5518 | | | | |
| | | | | | | | |
| FE6T NEW 6925 cc 6 cyl.  Surface Treatment Bore Clearance Anodized Crown MRC: 0.040 mm Tin Coated MP: 14.50 mm | \emptyset 108.00 -21.0 CD 65.5 TL 103.5 | 1 - 2.5 HK 1 - 2.0 1 - 4.0 | \emptyset 36.000 TL 90.00  | | TL 217.0 OD 111.0 FT 8.0 +0.9 FD 116.0 | TEIKIN NO. LKFF 44692A TEIKIN NO. 44692A R 44656 P 44692 B 44244 LFF 44261 REFERENCE NO. 12010-Z5968 12011-Z5968 REFERENCE NO. 12010-Z5519 12040-Z5560/1 12040-Z5564 REFERENCE NO. 12030-95000 REFERENCE NO. 11012-Z5518 | 158 |
| | TEIKIN NO. 44692A | TEIKIN NO. R 44656 | TEIKIN NO. P 44692 | TEIKIN NO. B 44244 | TEIKIN NO. LFF 44261 | | |
| | REFERENCE NO. 12010-Z5968 12011-Z5968 | REFERENCE NO. 12010-Z5519 12040-Z5560/1 12040-Z5564 | REFERENCE NO. 12030-95000 | REFERENCE NO. 11012-Z5518 | | | |
| | | | | | | | |
| FE6TA 6925 cc 6 cyl.  Surface Treatment Bore Clearance Tin Coated MRC: 0.080 mm MP: 15.50 mm | \emptyset 108.00 -22.1 CD 65.5 TL 103.5 | 1 - 2.5 HK 1 - 2.0 1 - 4.0 | \emptyset 36.000 TL 92.50  | | TL 217.0 OD 111.0 FT 8.0 +0.9 FD 116.0 | TEIKIN NO. LKFF 44656A LKSF 44656A TEIKIN NO. 44656A R 44656 P 44261 B 44244 LFF 44261 LSF 44261 REFERENCE NO. 12010-Z5507 12011-Z5768 12010-96507 12011-96507 REFERENCE NO. 12040-Z5519 12040-Z5560/1 12040-Z5564 12040-Z5919 REFERENCE NO. 12030-95000 12030-95001 REFERENCE NO. 11012-Z5518 | 159 |
| | TEIKIN NO. 44656A | TEIKIN NO. R 44656 | TEIKIN NO. P 44261 | TEIKIN NO. B 44244 | TEIKIN NO. LFF 44261 LSF 44261 | | |
| | REFERENCE NO. 12010-Z5507 12011-Z5768 12010-96507 12011-96507 | REFERENCE NO. 12040-Z5519 12040-Z5560/1 12040-Z5564 12040-Z5919 | REFERENCE NO. 12030-95000 12030-95001 | REFERENCE NO. 11012-Z5518 | | | |
| | | | | | | | |

| ENGINE TYPE | PISTON | PISTON RING | PISTON PIN | PIN BUSHING | LINER | | LINER KIT SET | | | | |
|--|--|----------------------------------|--|-------------|---|-----------|--|---|---|---|-----|
| | | | | | FLANGED | NO FLANGE | | | | | |
| NE6T 7412 cc 6 cyl.  Surface Treatment: Anodized Crown Bore Clearance: MRC: 0.140 mm, MP: 16.50 mm | \emptyset 110.00 -27.8 CD 68.3 TL 110.3 | 1 - 3.0 HK 1 - 2.5 1 - 4.0 | \emptyset 38.000 TL 92.50  | | | | TEIKIN NO. 44320A REFERENCE NO. 12010-94114 | TEIKIN NO. 164 | | | |
| PD6 10308 cc 1970 6 cyl.  Surface Treatment: None Bore Clearance: MRC: 0.150 mm, MP: 20.00 mm | \emptyset 125.00 -28.2 CD 82.0 TL 132.0 | 1 - 5.0 1 - 3.5 1 - 5.0 | \emptyset 46.000 TL 107.00  | | TL 259.0 OD 130.0 FT 3.0 +1.0 FD 134.0 | | TEIKIN NO. 44236 44236A REFERENCE NO. 12011-96000 12011-96007 | TEIKIN NO. LKFF 44236 LKFF 44236A REFERENCE NO. 12040-90029 12040-96009/26 12040-96127 12040-96226 | TEIKIN NO. P 44236 B 44236 REFERENCE NO. 12030-96000 12030-96001 | TEIKIN NO. LFF 44236 REFERENCE NO. 11012-96000 11012-96001 | 165 |
| PD6-T 10308 cc 6 cyl.  Surface Treatment: Tin Coated Bore Clearance: MRC: 0.170 mm, MP: 13.50 mm | \emptyset 125.00 -28.2 CD 82.0 TL 132.0 | 1 - 4.0 FK 1 - 3.5 1 - 5.0 | \emptyset 46.000 TL 108.00  | | TL 259.0 OD 130.0 FT 3.0 +1.0 FD 134.0 | | TEIKIN NO. 44679A REFERENCE NO. 12011-96005 12011-96009 | TEIKIN NO. R 44679 REFERENCE NO. 12040-90228 12040-96005 12040-96125/9 | TEIKIN NO. P 44679 B 44236 REFERENCE NO. 12030-96000 12030-96001 | TEIKIN NO. LFF 44236 REFERENCE NO. 11012-96000 11012-96001 | 166 |
| PE6 11670 cc 6 cyl.  Surface Treatment: Tin Coated Bore Clearance: MRC: 0.160 mm, MP: 13.50 mm | \emptyset 133.00 -32.5 CD 82.0 TL 132.0 | 1 - 4.0 FK 1 - 3.5 1 - 6.0 | \emptyset 46.000 TL 116.00  | | TL 259.0 OD 138.0 FT 3.0 +1.0 FD 142.0 | | TEIKIN NO. 44655A REFERENCE NO. 12011-96508 12011-96516 | TEIKIN NO. R 44655 REFERENCE NO. 12040-96028 12040-96128 12040-96500 12040-96503 | TEIKIN NO. P 44242 B 44236 REFERENCE NO. 12030-96000 12030-96001 | TEIKIN NO. LFF 44330 REFERENCE NO. 11012-96500 11012-96501 11012-96566 | 167 |

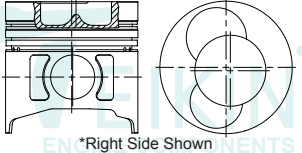
| ENGINE TYPE | PISTON | PISTON RING | PISTON PIN | PIN BUSHING | LINER | | LINER KIT SET |
|--|---|--|---------------------------------------|---|--|-----------|---|
| | | | | | FLANGED | NO FLANGE | |
| PE6-T 11670 cc 6 cyl. Surface Treatment Tin Coated Bore Clearance MRC: 0.170 mm MP: 10.00 mm | \varnothing 133.00 -32.5 CD 82.0 TL 132.0 | 1 - 4.0 HK 1 - 3.5 1 - 6.0 | \varnothing 46.000 TL 116.00 | | TL OD 259.0 FT 3.0 +1.0 FD 142.0 | | TEIKIN NO. LKFF 44330A |
| | TEIKIN NO. | TEIKIN NO. | TEIKIN NO. | TEIKIN NO. | TEIKIN NO. | | |
| | 44330A | R 44330 | P 44242 | B 44236 | LFF 44330 | | |
| | REFERENCE NO. | REFERENCE NO. | REFERENCE NO. | REFERENCE NO. | REFERENCE NO. | | |
| | 12011-96509 12011-96776 | 12040-96504 12040-96509 12040-96513 12040-96518 | | 12030-96000 12030-96001 | 11012-96500 11012-96501 11012-96566 | | 168 |
| RD8 14313 cc 8 cyl. 1972 Surface Treatment Tin Coated Bore Clearance MRC: 0.160 mm MP: 26.00 mm | \varnothing 135.00 -25.1 CD 82.0 TL 136.9 | 1 - 4.0 1 - 3.0 1 - 6.0 | \varnothing 46.000 TL 116.00 | | TL OD 243.0 FT 8.0 +1.0 FD 161.0 | | TEIKIN NO. LKFF 44242 LKFF44242A |
| | TEIKIN NO. | TEIKIN NO. | TEIKIN NO. | TEIKIN NO. | TEIKIN NO. | | |
| | 44242 44242A | R 44242 | P 44242 | B 44242-10 | LFF 44242 | | |
| | REFERENCE NO. | REFERENCE NO. | REFERENCE NO. | REFERENCE NO. | REFERENCE NO. | | |
| | 12011-97004 12011-97006 12011-97012/79 | 12040-97007 12040-97126 12040-97127 12040-97527 | | 12030-97000 12030-97001 12030-97002 | 11012-97001 11012-97025 11012-97063 11012-97077 | | 169 |
| RE8 8 cyl. Surface Treatment Tin Coated Bore Clearance MRC: 0.150 mm MP: 31.00 mm | \varnothing 135.00 -27.5 CD 78.6 TL 137.1 | 2 - 3.0 1 - 5.0 | \varnothing 46.000 TL 116.00 | | TL OD 238.0 FT 11.1 +3.1 FD 161.0 | | TEIKIN NO. LKFF 44264A |
| | TEIKIN NO. | TEIKIN NO. | TEIKIN NO. | TEIKIN NO. | TEIKIN NO. | | |
| | 44264A | R 44264 | P 44242 | B 44242 | LFF 44264 | | |
| | REFERENCE NO. | REFERENCE NO. | REFERENCE NO. | REFERENCE NO. | REFERENCE NO. | | |
| | 12011-97107 | 12040-97012/61/68 12040-97074/9 12040-97325/427 12040-97625 | | 12030-97000 12030-97001 12030-97002 | 11012-97118 11012-97161 11012-97127 | | 170 |
| RE10 10 cyl. Surface Treatment Tin Coated Bore Clearance MRC: 0.150 mm MP: 31.00 mm | \varnothing 135.00 -27.5 CD 78.5 TL 137.0 | 2 - 3.0 1 - 5.0 | \varnothing 46.000 TL 116.00 | | TL OD 238.0 FT 11.1 +3.1 FD 161.0 | | TEIKIN NO. LKFF 44264A-10 LKSF 44264A-10 |
| | TEIKIN NO. | TEIKIN NO. | TEIKIN NO. | TEIKIN NO. | TEIKIN NO. | | |
| | 44264A-10 | R 44264 | P 44242 | B 44242-10 | LFF 44264-10 | | |
| | REFERENCE NO. | REFERENCE NO. | REFERENCE NO. | REFERENCE NO. | REFERENCE NO. | | |
| | 12011-97107 | 12040-97012/61/68 12040-97074/9 12040-97325/427 12040-97625 | | 12030-97000 12030-97001 12030-97002 | 11012-97118 11012-97161 11012-97127 | | 171 |

| ENGINE TYPE | PISTON | PISTON RING | PISTON PIN | PIN BUSHING | LINER | | LINER KIT SET |
|--|--|--|---|---|--|--|---|
| | | | | | FLANGED | NO FLANGE | |
| RF8 8 cyl.  *Right Side Shown | Ø 138.00 -24.7 CD 78.6 TL 137.0 | 2 - 2.5 1 - 4.0 | Ø 46.000 TL 116.00  | | TL 238.0 OD 159.0 FT 11.1 +1.3 FD 167.0 | | TEIKIN NO. LKFF 44290 LKSF 44290 LKFF 44290A LKSF 44290A |
| Surface Treatment Tin Coated | Bore Clearance MRC: 0.050 mm MP: 30.40 mm | TEIKIN NO. 44290 44290A | TEIKIN NO. R 44290 | TEIKIN NO. P 44242 | TEIKIN NO. B 44242 | TEIKIN NO. LFF 44290 LSF 44290 | 172 |
| REFERENCE NO. 12011-97165 (R) 12011-97161 (L) | | REFERENCE NO. 12040-97072 12040-97104 | | REFERENCE NO. 12030-97000 12030-97001 12030-97002 | | REFERENCE NO. 11012-97164 11012-97171 | |
| RF10 10 cyl. | Ø 138.00 -24.7 CD 78.6 TL 137.0 | 2 - 2.5 1 - 4.0 | Ø 46.000 TL 116.00  | | | | TEIKIN NO. |
| Surface Treatment Tin Coated | Bore Clearance MRC: 0.050 mm MP: 30.40 mm | TEIKIN NO. 44290-10 44290A-10 | TEIKIN NO. P 44242 | | | | 173 |
| REFERENCE NO. 12011-97165 (R) 12011-97161 (L) | | | | | | | |

N

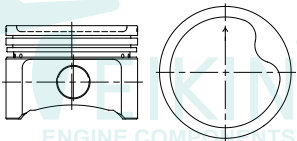
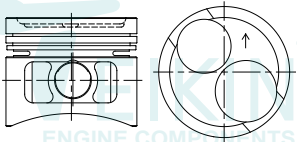
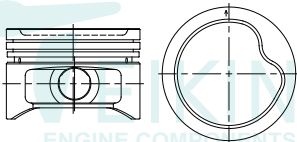
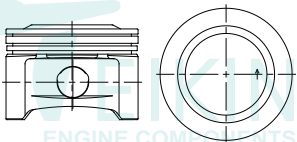

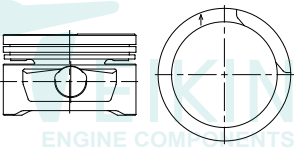
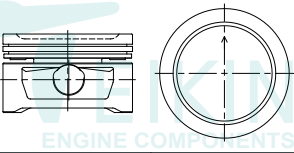
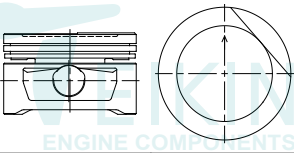
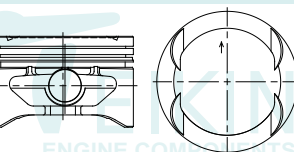

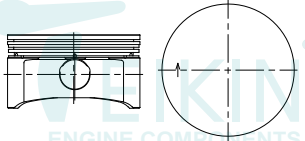
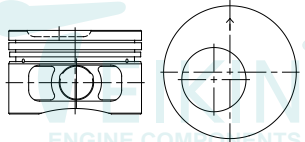
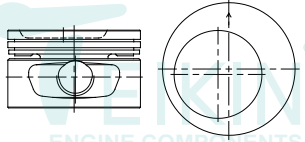
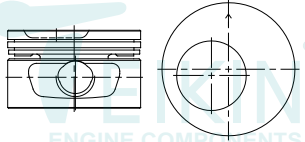

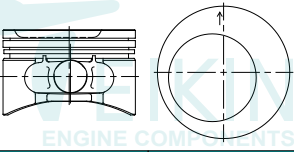
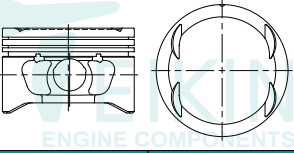
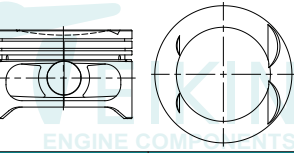
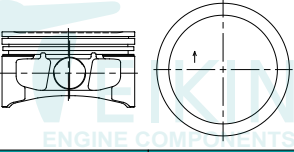
| ENGINE TYPE | PISTON | PISTON RING | PISTON PIN | PIN BUSHING | LINER | | LINER KIT SET |
|--|--|-------------------------------|--------------------------------|-------------|---------|-----------|---------------|
| | | | | | FLANGED | NO FLANGE | |
| 1.3 NE 4 cyl.  Surface Treatment None Bore Clearance MRC: 0.030 mm MP: 10.00 mm | \emptyset 75.00 -3.4 CD 32.1 TL 53.1 | 2 - 1.5 1 - 3.0 | \emptyset 18.000 TL 47.50 | | | | TEIKIN NO. |
| | TEIKIN NO. 56106 (48121) | | TEIKIN NO. P 30110 | | | | 1 |
| | REFERENCE NO. | | | | | | |
| 1300S, 13S 1297 cc 4 cyl. ASCONA 1.3L KADETT 'T' CAT 1.3 GL KADETT 1300 CL & GLS 1980  Surface Treatment None Bore Clearance MRC: 0.030 mm MP: 10.45 mm | \emptyset 75.00 -3.6 CD 35.9 TL 62.3 | 2 - 1.5 1 - 4.0 | \emptyset 20.000 TL 65.00 | | | | TEIKIN NO. |
| | TEIKIN NO. 56101 (48103) | | TEIKIN NO. P 56101 | | | | 2 |
| | REFERENCE NO. KS : 93 868 600 | | | | | | |
| 14 NV, 14 NVH 1389 cc 4 cyl. C 14 NZ KAT CORSA 1.4 1990-93 KADETT E 1.4 1989-91  Surface Treatment Tin Coated Bore Clearance MRC: 0.020 mm MP: 7.50 mm | \emptyset 77.60 -3.4 CD 32.1 TL 52.6 | 2 - 1.5 1 - 3.0 | \emptyset 18.000 TL 53.00 | | | | TEIKIN NO. |
| | TEIKIN NO. 56600 (48122) | | TEIKIN NO. P 46332 | | | | 3 |
| | REFERENCE NO. KS : 97 286 600 93218385 | | | | | | |
| Z 1.4 XE 1389 cc 4 cyl. ASTRA 1999 CORSA 1999  Surface Treatment Tin Coated Bore Clearance MRC: 0.030 mm MP: 10.00 mm | \emptyset 77.60 +2.4 CD 31.3 TL 55.7 | 1 - 1.2 1 - 1.5 1 - 2.0 | \emptyset 18.000 TL 56.00 | | | | TEIKIN NO. |
| | TEIKIN NO. 56110 | | TEIKIN NO. P 30104 | | | | 4 |
| | REFERENCE NO. 24407186 MAHLE : 012 10 00 | | | | | | |

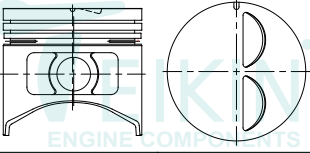
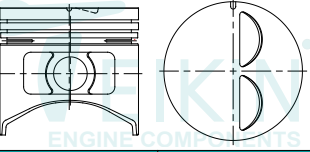
| ENGINE TYPE | PISTON | PISTON RING | PISTON PIN | PIN BUSHING | LINER | | LINER KIT SET |
|--|--|-------------------------------|--------------------------------|-------------|---------|-----------|---------------|
| | | | | | FLANGED | NO FLANGE | |
| 1.6 LZ 1598 cc ASCONA, KADETT 1986-87 4 cyl. | \emptyset 79.00 -2.7 CD 28.0 TL 48.3 | 1 - 1.2 1 - 1.5 1 - 3.0 | \emptyset 18.000 TL 56.00 | | | | TEIKIN NO. |
|  | | TEIKIN NO. | TEIKIN NO. | | | | |
| Surface Treatment Bore Clearance Tin Coated MRC: 0.030 mm MP: 5.50 mm | | REFERENCE NO. | | | | | |
| | | | | | | | 5 |
| 1.6 SE CORSA EFI PICK UP 4 cyl. | \emptyset 79.00 -3.1 CD 28.0 TL 47.9 | 1 - 1.2 1 - 1.5 1 - 3.0 | \emptyset 18.000 TL 56.00 | | | | TEIKIN NO. |
|  | | TEIKIN NO. | TEIKIN NO. | | | | |
| Surface Treatment Bore Clearance Tin Coated MRC: 0.030 mm MP: 5.50 mm | | REFERENCE NO. | | | | | |
| | | | | | | | 6 |
| 1.6 SV, 16 SV KAT 1598 cc E 16 SE KADETT 1600, MONZA 1600 ASCONA 1600 1987 - ON 4 cyl. | \emptyset 79.00 +0.5 CD 28.0 TL 48.5 | 1 - 1.2 1 - 1.5 1 - 3.0 | \emptyset 18.000 TL 56.00 | | | | TEIKIN NO. |
|  | | TEIKIN NO. | TEIKIN NO. | | | | |
| Surface Treatment Bore Clearance Tin Coated MRC: 0.030 mm MP: 5.50 mm | | REFERENCE NO. | | | | | |
| | | | | | | | 7 |
| X 1.6 XE / XEL 1598 cc 4 cyl. | \emptyset 79.00 -0.8 CD 28.0 TL 51.0 | 1 - 1.2 1 - 1.5 1 - 3.0 | \emptyset 18.000 TL 55.00 | | | | TEIKIN NO. |
|  | | TEIKIN NO. | TEIKIN NO. | | | | |
| Surface Treatment Bore Clearance Tin Coated MRC: 0.030 mm MP: 7.00 mm | | REFERENCE NO. | | | | | |
| | | | | | | | 8 |

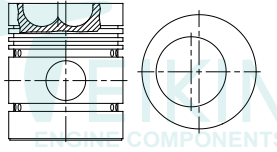
| ENGINE TYPE | PISTON | PISTON RING | PISTON PIN | PIN BUSHING | LINER | | LINER KIT SET |
|---|--|--------------------|--------------------------------|-------------|---------|-----------|---------------|
| | | | | | FLANGED | NO FLANGE | |
| X 18XE 1796 cc 4 cyl. ASTRA 1.8i 16V 1997- VECTRA 1.8i 16V 1998- ZAFIRA 1.8i 16 V 1999- MERIVA 1.8i 16V 2003-  | \emptyset 80.50 CD 24.1 TL 44.7 | 2 - 1.2 1 - 2.0 | \emptyset 18.00 TL 56.00 | | | | TEIKIN NO. |
| Surface Treatment Bore Clearance Tin Coated MRC: 0.030 mm Moly Skirt MP: 9.00 mm | TEIKIN NO. 56113 | | TEIKIN NO. P 30104 | | | | 9 |
| | REFERENCE NO. KS : 99 741 601 | | | | | | |
| 1800 1796 cc 4 cyl. MONZA 1800 KADET 1800 ASCONA 1800 1987  | \emptyset 84.80 CD 33.7 TL 53.7 -4.0 | 2 - 1.5 1 - 3.0 | \emptyset 21.000 TL 61.50 | | | | TEIKIN NO. |
| Surface Treatment Bore Clearance Tin Coated MRC: 0.020 mm MP: 5.85 mm | TEIKIN NO. 56104 (48104) | | TEIKIN NO. P 56104 | | | | 10 |
| | REFERENCE NO. | | | | | | |
| 2.0 X 2000 cc 4 cyl.  | \emptyset 86.00 CD 30.4 TL 50.4 -5.1 | 2 - 1.5 1 - 3.0 | \emptyset 21.000 TL 61.50 | | | | TEIKIN NO. |
| Surface Treatment Bore Clearance Tin Coated MRC: 0.030 mm MP: 3.00 mm | TEIKIN NO. 56108 | | TEIKIN NO. P 56104 | | | | 11 |
| | REFERENCE NO. MAHLE : 011 75 00 | | | | | | |
| 20 SE, X20 SE KAT 1998 cc 4 cyl. ASCONA C20 1987-88 KADETT E20 1986-91 OMEGAA 2.0  | \emptyset 86.00 CD 30.4 TL 50.4 -5.0 | 2 - 1.5 1 - 3.0 | \emptyset 21.000 TL 61.50 | | | | TEIKIN NO. |
| Surface Treatment Bore Clearance Tin Coated MRC: 0.030 mm MP: 3.00 mm | TEIKIN NO. 56601 (48115) | | TEIKIN NO. P 56104 | | | | 12 |
| | REFERENCE NO. KS : 90 245 600 | | | | | | |

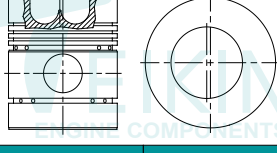
| ENGINE TYPE | PISTON | PISTON RING | PISTON PIN | PIN BUSHING | LINER | | LINER KIT SET |
|--|--|-------------------------------|--|-------------|---------|-----------|---------------|
| | | | | | FLANGED | NO FLANGE | |
| C20NE KAT 1998 cc VECTRA A 1988-1995 ASTRA E 1986-1991 ASTRA F 1991-1998 4 cyl. | Ø 86.00 -5.0 CD 30.4 TL 55.4 | 2 - 1.5 1 - 3.0 | Ø 21.000 TL 61.50 | | | | TEIKIN NO. |
|  | TEIKIN NO. 56112 | | TEIKIN NO. P 56104 | | | | |
| Surface Treatment Tin Coated | Bore Clearance MRC: 0.030 mm MP: 11.50 mm | | REFERENCE NO. 93359959 KS : 92 123 600 | | | | 13 |
| C20XE4V KAT 1998 cc 4 cyl. | Ø 86.00 -0.8 CD 30.4 TL 55.3 | 2 - 1.5 1 - 3.0 | Ø 21.000 TL 61.50 | | | | TEIKIN NO. |
|  | TEIKIN NO. 56107 (48118) | | TEIKIN NO. P 56104 | | | | |
| Surface Treatment Tin Coated | Bore Clearance MRC: 0.030 mm MP: 9.00 mm | | REFERENCE NO. KS : 91 023 700 | | | | 14 |
| C 2.0 XEV 1998 cc X 2.0 XEV 4 cyl. | Ø 86.00 -3.2 CD 30.1 TL 55.5 | 2 - 1.5 1 - 3.0 | Ø 21.000 TL 61.50 | | | | TEIKIN NO. |
|  | TEIKIN NO. 56604 | | TEIKIN NO. P 56104 | | | | |
| Surface Treatment Tin Coated | Bore Clearance MRC: 0.030 mm MP: 9.00 mm | | REFERENCE NO. KS: 97 332 600 MAHLE: 011 73 00 | | | | 15 |
| Z 22 SE 2198 cc VECTRA B 2000-2002 VECTRA C 2001- ASTRA G 2000-2004 ZAFIRA 2000 4 cyl. | Ø 86.00 -0.6 CD 26.8 TL 48.9 | 1 - 1.2 1 - 1.5 1 - 2.5 | Ø 20.000 TL 62.00 | | | | TEIKIN NO. |
|  | TEIKIN NO. 56111 | | TEIKIN NO. P 38129 | | | | |
| Surface Treatment Tin Coated Anodized Crown 1st Ring Anodized | Bore Clearance MRC: 0.030 mm MP: 9.50 mm | | REFERENCE NO. 90537911 KS : 94 912 600 | | | | 16 |

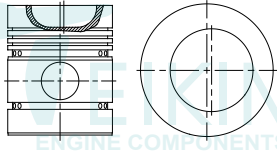
| ENGINE TYPE | PISTON | PISTON RING | PISTON PIN | PIN BUSHING | LINER | | LINER KIT SET |
|---|--|--------------------|---|-------------|---------|-----------|---------------|
| | | | | | FLANGED | NO FLANGE | |
| 20E CIH, 20S 1979 cc 4 cyl. ASCONA B20 1977-81 MONZA A2.0, A3.0 REKORD D2.0, E2.0 MANTA B2.0, SENATOR A2.0 | Ø 95.00 -3.5 CD 45.0 TL 87.0 | 2 - 2.0 1 - 4.0 | Ø 23.000 TL 76.00 | | | | TEIKIN NO. |
|  | TEIKIN NO. 56105 (48119) | | TEIKIN NO. P 56105 | | | | |
| Surface Treatment Tin Coated | Bore Clearance MRC: 0.030 mm MP: 26.00 mm | | REFERENCE NO. KS : 93 221 600 | | | | |
| | | | | | | | 17 |
| 3.0 E/NE 2969 cc 6 cyl. OMEGA 78-04 SENATOR 1978- MONZA 1978- | Ø 95.00 -3.5 CD 45.0 TL 87.0 | 2 - 2.0 1 - 4.0 | Ø 23.000 TL 76.00 | | | | TEIKIN NO. |
|  | TEIKIN NO. 56105-6 | | TEIKIN NO. P 56105 | | | | |
| Surface Treatment Tin Coated | Bore Clearance MRC: 0.030 mm MP: 26.00 mm | | REFERENCE NO. KS : 93 221 600 | | | | |
| | | | | | | | 18 |

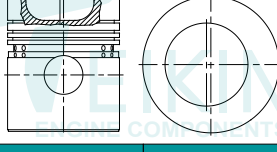
| ENGINE TYPE | PISTON | PISTON RING | PISTON PIN | PIN BUSHING | LINER | | LINER KIT SET |
|---|--|-------------------------------|---|-------------|---------|-----------|---------------|
| | | | | | FLANGED | NO FLANGE | |
| 68322 (NEW) 3335 cc AD 4.203, D 4.203 AD 3.152, D 3.152 (3Cyl) 4 cyl. | \emptyset 91.48 -18.5 CD 61.9 TL 109.6 | 2 - 2.4 1 - 3.2 2 - 6.4 | \emptyset 31.750 TL 75.00  | | | | TEIKIN NO. |
|  | TEIKIN NO. G8102 | | TEIKIN NO. P 42149 | | | | |
| Surface Treatment Bore Clearance None MRC: 0.130 mm MP: 20.00 mm | REFERENCE NO. KS : 92 772 600 | | | | | | |
| | | | | | | 1 | |
| 6.354 5800 cc 6 cyl. | \emptyset 98.43 -25.4 CD 69.8 TL 120.6 | 3 - 2.4 2 - 6.4 | \emptyset 34.925 TL 84.00  | | | | TEIKIN NO. |
|  | TEIKIN NO. G8101 | | TEIKIN NO. P G8101 | | | | |
| Surface Treatment Bore Clearance Tin Coated MRC: 0.110 mm MP: 23.40 mm | REFERENCE NO. | | | | | | |
| | | | | | | 2 | |
| 4.236, A4.236 3864 cc 1961 - ON 4 cyl. | \emptyset 98.48 -20.5 CD 70.3 TL 121.0 | 3 - 2.4 2 - 6.4 | \emptyset 34.925 TL 84.00  | | | | TEIKIN NO. |
|  | TEIKIN NO. G8104 | | TEIKIN NO. P G8104 | | | | |
| Surface Treatment Bore Clearance None MRC: 0.180 mm MP: 23.00 mm | REFERENCE NO. 68301 KS : 91 118 600 | | | | | | |
| | | | | | | 3 | |
| 4.248 4067 cc 1963 - ON 4 cyl. | \emptyset 101.054 -20.7 CD 69.9 TL 120.8 | 3 - 2.4 1 - 6.4 | \emptyset 34.925 TL 84.00  | | | | TEIKIN NO. |
|  | TEIKIN NO. G8103 | | TEIKIN NO. P G8101 | | | | |
| Surface Treatment Bore Clearance Tin Coated MRC: 0.184 mm MP: 16.70 mm | REFERENCE NO. KS : 92 144 800 | | | | | | |
| | | | | | | 4 | |



P

SUITABLE FOR

PEUGEOT

GASOLINE

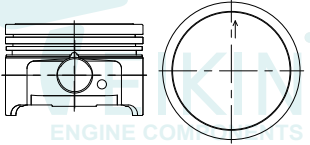
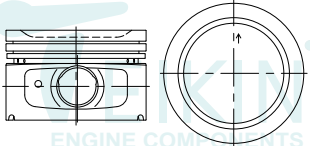
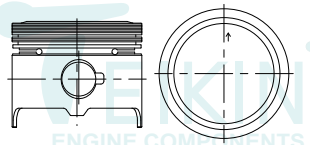

| ENGINE TYPE | PISTON | PISTON RING | PISTON PIN | PIN BUSHING | LINER | | LINER KIT SET |
|---|--|-------------------------------|---|-------------|---------|-----------|---------------|
| | | | | | FLANGED | NO FLANGE | |
| 2031 70 4 cyl. | \varnothing 75.00 +0.3 CD 27.7 TL 50.0 | 2 - 1.5 1 - 2.5 | \varnothing 17.984 TL 55.00 | | | | TEIKIN NO. |
|  | | | | | | | |
| TEIKIN NO. 67101 | | | TEIKIN NO. P 67101 | | | | |
| REFERENCE NO. | | | | | | | |
| Surface Treatment Tin Coated | Bore Clearance MRC: 0.040 mm MP: 10.00 mm | | | | | | 1 |
| 2297 50 4 cyl. | \varnothing 83.00 -4.1 CD 33.3 TL 53.3 | 2 - 1.5 1 - 3.0 | \varnothing 22.000 TL 62.00 | | | | TEIKIN NO. |
|  | | | | | | | |
| TEIKIN NO. 67102 | | | TEIKIN NO. P 43222 | | | | |
| REFERENCE NO. | | | | | | | |
| Surface Treatment Tin Coated | Bore Clearance MRC: 0.043 mm MP: 5.00 mm | | | | | | 2 |
| 2297 90 4 cyl. | \varnothing 88.00 +1.2 CD 38.0 TL 72.0 | 1 - 1.5 1 - 2.0 1 - 4.0 | \varnothing 23.000 TL 74.00 | | | | TEIKIN NO. |
|  | | |  | | | | |
| TEIKIN NO. 67103 | | | TEIKIN NO. P 67103 | | | | |
| REFERENCE NO. | | | | | | | |
| Surface Treatment Tin Coated | Bore Clearance MRC: 0.060 mm MP: 17.00 mm | | | | | | 3 |

P

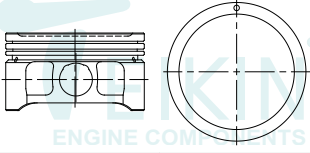
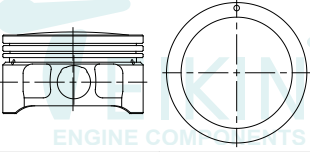





| ENGINE TYPE | PISTON | PISTON RING | PISTON PIN | PIN BUSHING | LINER | | LINER KIT SET |
|--|--|---------------------------|----------------------------------|-------------|---------|-----------|---------------|
| | | | | | FLANGED | NO FLANGE | |
| GEN 2 1600 cc 4 cyl. | \varnothing 76.00 -1.7 CD 25.5 TL 42.5 | 2 - 1.2 1 - 2.5 | \varnothing 18.000 TL 50.00 | | | | TEIKIN NO. |
|  | TEIKIN NO. 41601 | | TEIKIN NO. P 45136 | | | | |
| Surface Treatment Tin Coated | Bore Clearance MRC: 0.030 mm MP: 7.00 mm | REFERENCE NO. PW891195 | | | | | |
| | | | | | | | 1 |
| SAGA 4 cyl. | \varnothing 76.00 +1.7 CD 25.5 TL 42.5 | 2 - 1.2 1 - 2.5 | \varnothing 18.000 TL 50.00 | | | | TEIKIN NO. |
|  | TEIKIN NO. 41602 | | TEIKIN NO. P 45136 | | | | |
| Surface Treatment Tin Coated | Bore Clearance MRC: 0.030 mm MP: 7.00 mm | REFERENCE NO. | | | | | |
| | | | | | | | 2 |

SUITABLE FOR

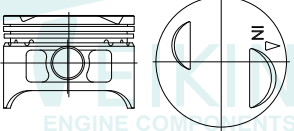
SUBARU

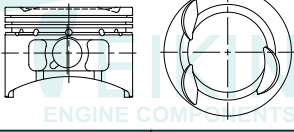
GASOLINE

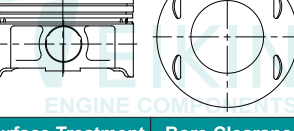

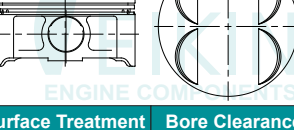
| ENGINE TYPE | PISTON | PISTON RING | PISTON PIN | PIN BUSHING | LINER | | LINER KIT SET |
|---|--|-------------------------------|--|-------------|---------|-----------|---------------|
| | | | | | FLANGED | NO FLANGE | |
| EF10 3 cyl. | Ø 78.00 -5.2 CD 28.4 TL 55.4 | 1 - 1.2 1 - 1.5 1 - 2.8 | Ø 18.00 TL 61.00  | | | | TEIKIN NO. |
|  | TEIKIN NO. 55650 | | TEIKIN NO. P 43187 | | | | |
| Surface Treatment Tin Coated | Bore Clearance MRC: 0.030 mm MP: 13.00 mm | | REFERENCE NO. 12011-KA920 12009-KA121 | | | | |
| | | | | | | | 1 |
| EF12 1189 cc 3 cyl. | Ø 78.00 -1.1 CD 28.0 TL 55.0 | 1 - 1.2 1 - 1.5 1 - 2.8 | Ø 18.00 TL 61.00  | | | | TEIKIN NO. |
|  | TEIKIN NO. 55652 | | TEIKIN NO. P 55652 | | | | |
| Surface Treatment Tin Coated | Bore Clearance MRC: 0.030 mm MP: 12.00 mm | | REFERENCE NO. 12009-KB060 | | | | |
| | | | | | | | 2 |
| EZ30D 6 cyl. | Ø 89.20 -1.3 CD 29.9 TL 50.7 | 2 - 1.2 1 - 2.5 | Ø 22.00 TL 52.00  | | | | TEIKIN NO. |
|  | TEIKIN NO. 55106 | | TEIKIN NO. P 55106 | | | | |
| Surface Treatment Moly Skirt | Bore Clearance MRC: 0.030 mm MP: 6.80 mm | | REFERENCE NO. 12006-AC470 | | | | |
| | | | | | | | 3 |
| EZ30D-II 6 cyl. | Ø 89.20 -4.6 CD 30.3 TL 50.8 | 2 - 1.2 1 - 2.0 | Ø 22.00 TL 52.00  | | | | TEIKIN NO. |
|  | TEIKIN NO. 55107 | | TEIKIN NO. P 55106 | | | | |
| Surface Treatment Moly Skirt | Bore Clearance MRC: 0.030 mm MP: 6.50 mm | | REFERENCE NO. 12006-AD450 | | | | |
| | | | | | | | 4 |

S









| ENGINE TYPE | PISTON | PISTON RING | PISTON PIN | PIN BUSHING | LINER | | LINER KIT SET |
|--|--|--|--------------------------|-------------|---------|-----------|---------------|
| | | | | | FLANGED | NO FLANGE | |
| EA71 1600 cc 4 cyl. | Ø 92.00 CD 32.0 TL 71.5 | 2 - 2.0 1 - 4.0 | Ø 21.000 TL 82.00 | | | | TEIKIN NO. |
| | TEIKIN NO. 55651 | | TEIKIN NO. P 55651 | | | | |
| Surface Treatment Tin Coated | Bore Clearance MRC: 0.030 mm MP: 25.00 mm | REFERENCE NO. 38005-4320 38005-4310 38005-4300 | | | | | 5 |
| EA82 1781 cc 4 cyl. | Ø 92.00 -4.0 CD 31.5 TL 65.0 | 2 - 2.0 1 - 4.0 | Ø 21.000 TL 70.00 | | | | TEIKIN NO. |
| | TEIKIN NO. 55653 | | TEIKIN NO. P 55653 | | | | |
| Surface Treatment Tin Coated | Bore Clearance MRC: 0.030 mm MP: 20.20 mm | REFERENCE NO. 12013-AA30(R/L) | | | | | 6 |
| EJ20 1994 cc 4 cyl. | Ø 92.00 -1.5 CD 33.3 TL 54.1 | 1 - 1.2 1 - 1.5 1 - 3.0 | Ø 23.000 TL 58.00 | | | | TEIKIN NO. |
| | TEIKIN NO. 55654 | | TEIKIN NO. P 55101 | | | | |
| Surface Treatment Moly Skirt | Bore Clearance MRC: 0.030 mm MP: 7.50 mm | REFERENCE NO. 12006-AA380 | | | | | 7 |
| EJ20-T DOHC 1998-2002 | Ø 92.00 -2.8 CD 32.7 TL 53.7 | 2 - 1.2 1 - 2.5 | Ø 23.000 TL 64.00 | | | | TEIKIN NO. |
| | TEIKIN NO. 55102 | | TEIKIN NO. P 55102 | | | | |
| Surface Treatment Anodized Crown Moly Skirt | Bore Clearance MRC: 0.030 mm MP: 6.50 mm | REFERENCE NO. 12006-AB231 12006-AB241 | | | | | 8 |

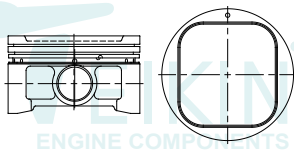



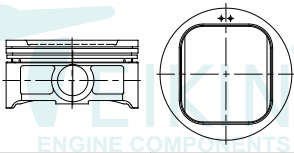

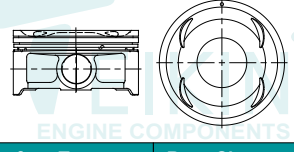
SUITABLE FOR

SUBARU

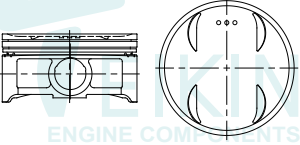
GASOLINE

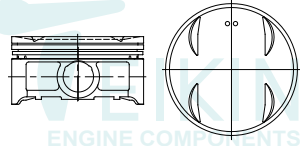

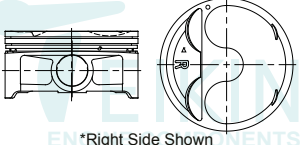
| ENGINE TYPE | PISTON | PISTON RING | PISTON PIN | PIN BUSHING | LINER | | LINER KIT SET |
|---|--|-------------------------------|---|-------------|---------|-----------|--|
| | | | | | FLANGED | NO FLANGE | |
| EJ20-T-II 1994 cc 4 cyl.  Surface Treatment: Anodized Crown, Moly Skirt Bore Clearance: MRC: 0.030 mm, MP: 6.50 mm | \emptyset 92.00 -3.6 CD 33.3 TL 54.1 | 2 - 1.5 1 - 3.0 | \emptyset 23.000 TL 62.00  | | | | TEIKIN NO. 9 |
| | TEIKIN NO. 55655 | TEIKIN NO. P 55103 | | | | | |
| | REFERENCE NO. 12006-AA630 | | | | | | |
| | | | | | | | |
| EJ22, EJ22E 2212 cc 4 cyl. F.I., SOHC, 16 V IMPRESSA 1996-99 LEGACY 1990-96  *Right Side Shown Surface Treatment: Tin Coated Bore Clearance: MRC: 0.030 mm, MP: 17.50 mm | \emptyset 96.90 -2.6 CD 33.0 TL 68.1 | 1 - 1.2 1 - 1.5 1 - 3.0 | \emptyset 23.000 TL 58.00  | | | | TEIKIN NO. 10 |
| | TEIKIN NO. 55101 | TEIKIN NO. P 55101 | | | | | |
| | REFERENCE NO. 12013-AA231 (R) 12018-AA231 (L) | | | | | | |
| | | | | | | | |
| EJ25 2457 cc 4 cyl. LEGACY (1996-99) FORESTER, IMPREZA (1998) F.I., DOHC 16V  Surface Treatment: Moly Skirt Bore Clearance: MRC: 0.030 mm, MP: 5.50 mm | \emptyset 99.50 -3.1 CD 30.3 TL 51.1 | 1 - 1.2 1 - 1.5 1 - 2.8 | \emptyset 23.000 TL 62.00  | | | | TEIKIN NO. 11 |
| | TEIKIN NO. 55103 | TEIKIN NO. P 55103 | | | | | |
| | REFERENCE NO. 12006-AB410 | | | | | | |
| | | | | | | | |
| EJ255-T 2547 cc 4 cyl. IMPREZA, LEGACY, OUTBACK FORESTER, BAJA 2004-2007 16V DOHC H4 F.INJ  Surface Treatment: Moly Skirt, Anodized Crown, 1st Ring Anodized Bore Clearance: MRC: 0.030 mm, MP: 6.50 mm | \emptyset 99.50 -4.8 CD 30.7 TL 51.4 | 2 - 1.2 1 - 2.0 | \emptyset 23.000 TL 64.00  | | | | TEIKIN NO. 12 |
| | TEIKIN NO. 55105 | TEIKIN NO. P 55102 | | | | | |
| | REFERENCE NO. 12006-AC400 12006-AC390 12006-AC410/20 12006-AD210 | | | | | | |
| | | | | | | | |





| ENGINE TYPE | PISTON | PISTON RING | PISTON PIN | PIN BUSHING | LINER | | LINER KIT SET |
|---|---|--------------------|---|-------------|---------|-----------|-----------------------------|
| | | | | | FLANGED | NO FLANGE | |
| EJ255-III 4 cyl.  | \varnothing 99.50 -1.8 CD 29.5 TL 50.3 | 2 - 1.2 1 - 2.0 | \varnothing 23.000 TL 62.00  | | | | TEIKIN NO. 13 |
| | TEIKIN NO. 55109 | | TEIKIN NO. P 55103 | | | | |
| | REFERENCE NO. 12006-AC870 | | | | | | |
| | Surface Treatment Moly Skirt Bore Clearance MRC: 0.030 mm MP: 5.50 mm | | | | | | |
| EJ25-II 4 cyl. BAJA 2004-2005 FORESTER 2004-2005 IMPREZA 2004-2005 LEGACY 2004-2005  | \varnothing 99.50 -1.6 CD 29.5 TL 50.1 | 2 - 1.2 1 - 2.5 | \varnothing 23.000 TL 62.00  | | | | TEIKIN NO. 14 |
| | TEIKIN NO. 55104 | | TEIKIN NO. P 55103 | | | | |
| | REFERENCE NO. 12006-AB470 | | | | | | |
| | Surface Treatment Moly Skirt Bore Clearance MRC: 0.030 mm MP: 8.00 mm | | | | | | |
| EJ255-II 4 cyl.  | \varnothing 99.50 -3.5 CD 29.5 TL 50.1 | 2 - 1.2 1 - 2.0 | \varnothing 23.000 TL 64.00  | | | | TEIKIN NO. 15 |
| | TEIKIN NO. 55108 | | TEIKIN NO. P 55102 | | | | |
| | REFERENCE NO. 12013-AB210 (R) 12018-AB210 (L) | | | | | | |
| | Surface Treatment Moly Skirt Bore Clearance MRC: 0.030 mm MP: 7.60 mm | | | | | | |

SUITABLE FOR

SUZUKI

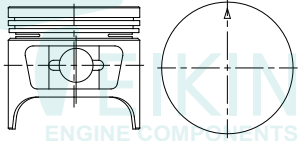
GASOLINE



| ENGINE TYPE | PISTON | PISTON RING | PISTON PIN | PIN BUSHING | LINER | | LINER KIT SET |
|---|---|-------------------------------|---|-------------|---------|-----------|-----------------------------|
| | | | | | FLANGED | NO FLANGE | |
| F8A 797 cc ST90 4 cyl.  | \emptyset 62.00 CD 27.5 TL 57.5 | 2 - 1.5 1 - 2.8 | \emptyset 16.000 TL 49.00  | | | | TEIKIN NO. 1 |
| | TEIKIN NO. 45652 | | TEIKIN NO. P 45114 | | | | |
| | REFERENCE NO. 12110-73002 12111-73002 | | | | | | |
| | Surface Treatment Bore Clearance Tin Coated MRC: 0.030 mm MP: 14.50 mm | | | | | | |
| F8A, ST90, LJ80 797 cc F5A (3 Cyl.) 1978 4 cyl. | \emptyset 62.00 CD 27.4 TL 57.4 | 2 - 1.5 1 - 2.8 | \emptyset 16.000 TL 49.00  | | | | TEIKIN NO. 2 |
| | TEIKIN NO. 45114 | | TEIKIN NO. P 45114 | | | | |
| | REFERENCE NO. 12111-78110 12111-78111 | | | | | | |
| | Surface Treatment Bore Clearance None MRC: 0.030 mm MP: 14.50 mm | | | | | | |
| F6A 3 cyl. | \emptyset 65.00 CD 25.6 TL 52.6 | 1 - 1.2 1 - 1.5 1 - 2.5 | \emptyset 16.000 TL 49.00  | | | | TEIKIN NO. 3 |
| | TEIKIN NO. 45138 | | TEIKIN NO. P 45114 | | | | |
| | REFERENCE NO. 12111-51E00 | | | | | | |
| | Surface Treatment Bore Clearance None MRC: 0.030 mm MP: 14.50 mm | | | | | | |
| F10A, ST100, SJ410 970 cc 1983 4 cyl. | \emptyset 65.50 CD 24.7 TL 55.0 | 2 - 1.5 1 - 2.8 | \emptyset 16.000 TL 52.50  | | | | TEIKIN NO. 4 |
| | TEIKIN NO. 45117 | | TEIKIN NO. P 45113 | | | | |
| | REFERENCE NO. 12111-75104 12111-75107 12111-85201 12111-85288L0B0 | | | | | | |
| | Surface Treatment Bore Clearance None MRC: 0.030 mm MP: 16.85 mm | | | | | | |







| ENGINE TYPE | PISTON | PISTON RING | PISTON PIN | PIN BUSHING | LINER | | LINER KIT SET |
|--|--|---|--------------------------------------|-------------|---------|-----------|---------------|
| | | | | | FLANGED | NO FLANGE | |
| K6A 3 cyl. | \varnothing 68.00 -0.8 CD 25.7 TL 52.6 | 1 - 1.0 1 - 1.2 1 - 2.0 | \varnothing 18.000 TL 50.00 | | | | TEIKIN NO. |
| ENGINE COMPONENTS | TEIKIN NO. 45151 | | TEIKIN NO. P 45136 | | | | |
| Surface Treatment Tin Coated | Bore Clearance MRC: 0.030 mm MP: 15.00 mm | REFERENCE NO. 12111-63C13 | | | | | 5 |
| ALTO K10A 4 cyl. | \varnothing 68.00 -2.5 CD 25.6 TL 52.5 | 1 - 1.0 1 - 1.2 1 - 2.0 | \varnothing 18.000 TL 50.00 | | | | TEIKIN NO. |
| ENGINE COMPONENTS | TEIKIN NO. 45136 | | TEIKIN NO. P 45136 | | | | |
| Surface Treatment None | Bore Clearance MRC: 0.030 mm MP: 15.00 mm | REFERENCE NO. 12100-75811-0B0 12100-75811-0A0 | | | | | 6 |
| ALTO LXI MARUTI 800CC MPFI 800 cc 3 cyl. | \varnothing 68.50 -2.9 CD 25.5 TL 52.4 | 1 - 1.2 1 - 1.5 1 - 2.5 | \varnothing 16.000 TL 49.00 | | | | TEIKIN NO. |
| ENGINE COMPONENTS | TEIKIN NO. 45146-3 | | TEIKIN NO. P 45114 | | | | |
| Surface Treatment None | Bore Clearance MRC: 0.030 mm MP: 14.80 mm | REFERENCE NO. 12111-84400-0A0 | | | | | 7 |
| SS80 F8B 800 cc 3 cyl. | \varnothing 68.50 -3.1 CD 24.9 TL 54.9 | 2 - 1.5 1 - 2.8 | \varnothing 16.000 TL 53.50 | | | | TEIKIN NO. |
| ENGINE COMPONENTS | TEIKIN NO. 45122 | | TEIKIN NO. P 45122 | | | | |
| Surface Treatment Tin Coated | Bore Clearance MRC: 0.030 mm MP: 17.00 mm | REFERENCE NO. 12111-78400 12111-78402 | | | | | 8 |

SUITABLE FOR

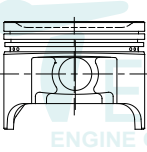
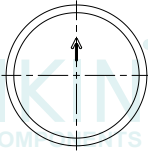

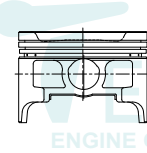
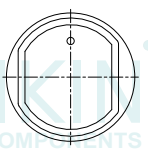

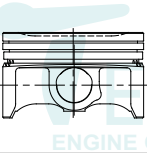
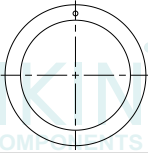
SUZUKI

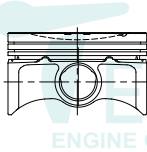
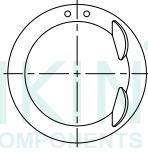
GASOLINE

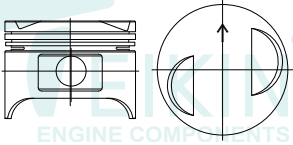
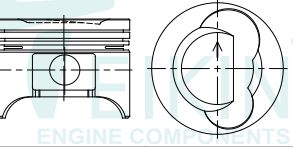
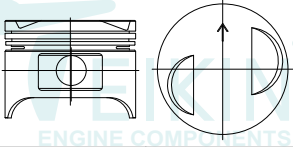
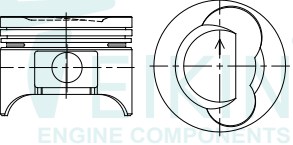

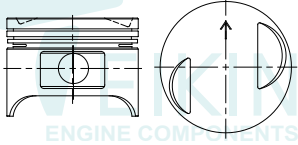
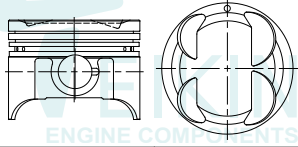

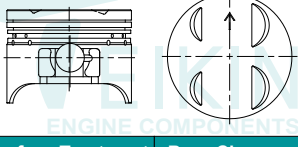

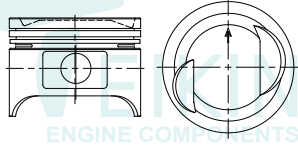

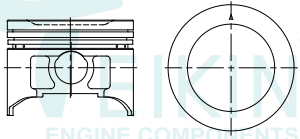

| ENGINE TYPE | PISTON | PISTON RING | PISTON PIN | PIN BUSHING | LINER | | LINER KIT SET |
|---|--|-------------------------------|---|-------------|---------|-----------|---------------|
| | | | | | FLANGED | NO FLANGE | |
| WAGON R 4 cyl. | \varnothing 68.50 -2.9 CD 25.5 TL 52.4 | 1 - 1.2 1 - 1.5 1 - 2.5 | \varnothing 16.000 TL 49.00  | | | | TEIKIN NO. |
|   | TEIKIN NO. 45146 | | TEIKIN NO. P 45114 | | | | |
| Surface Treatment Bore Clearance None MRC: 0.030 mm MP: 14.80 mm | REFERENCE NO. 12111-84400-0A0 | | | | | | 9 |
| K12A 4 cyl. | \varnothing 71.00 -5.9 CD 23.5 TL 50.4 | 1 - 1.0 1 - 1.2 1 - 2.0 | \varnothing 17.000 TL 50.00  | | | | TEIKIN NO. |
|   | TEIKIN NO. 45141 | | TEIKIN NO. P 45141 | | | | |
| Surface Treatment Bore Clearance None MRC: 0.030 mm MP: 15.50 mm | REFERENCE NO. 12100-75821-0A0 | | | | | | 10 |
| K10B CELERIO 1.0 L 998 cc 3 cyl. | \varnothing 73.00 -1.8 CD 27.3 TL 44.3 | 1 - 1.0 1 - 1.2 1 - 2.0 | \varnothing 18.000 TL 50.00  | | | | TEIKIN NO. |
|   | TEIKIN NO. 45145 | | TEIKIN NO. P 45136 | | | | |
| Surface Treatment Bore Clearance None MRC: 0.030 mm MP: 5.50 mm | REFERENCE NO. 12100-M68850 | | | | | | 11 |
| K14B 4 cyl. | \varnothing 73.00 -3.8 CD 26.0 TL 43.3 | 1 - 1.0 1 - 1.2 1 - 2.0 | \varnothing 18.000 TL 46.50  | | | | TEIKIN NO. |
|   | TEIKIN NO. 45148 | | TEIKIN NO. P 45148 | | | | |
| Surface Treatment Bore Clearance Moly Skirt MRC: 0.030 mm MP: 6.50 mm | REFERENCE NO. 12111B71L50N0A0 | | | | | | 12 |

| ENGINE TYPE | PISTON | PISTON RING | PISTON PIN | PIN BUSHING | LINER | | LINER KIT SET |
|--|--|-------------------------------|--------------------------------|-------------|---------|-----------|---------------|
| | | | | | FLANGED | NO FLANGE | |
| G10 993 cc 3 cyl. GM SPRINT 1985-88 SOHC, 6 V, CARB | \emptyset 74.00 -5.6 CD 28.4 TL 55.3 | 1 - 1.2 1 - 1.5 1 - 2.8 | \emptyset 17.000 TL 65.00 | | | | TEIKIN NO. |
|  | TEIKIN NO. 45126 | TEIKIN NO. P 45125 | | | | | |
| Surface Treatment Tin Coated Bore Clearance MRC: 0.030 mm MP: 13.50 mm | REFERENCE NO. 12111-82010 | | | | | | |
| | | | | | | | |
| G10 NEW, G10A 993 cc 3 cyl. GM METRO F.I., SOHC 6 V 1989-2000 | \emptyset 74.00 -2.1 CD 28.7 TL 55.7 | 1 - 1.2 1 - 1.5 1 - 2.8 | \emptyset 17.000 TL 65.00 | | | | TEIKIN NO. |
|  | TEIKIN NO. 45125 | TEIKIN NO. P 45125 | | | | | |
| Surface Treatment Tin Coated Bore Clearance MRC: 0.030 mm MP: 13.80 mm | REFERENCE NO. 12111-60B00-0B0 12111-61810-0B0 96060039 | | | | | | |
| | | | | | | | |
| G13 1298 cc 4 cyl. | \emptyset 74.00 -5.6 CD 28.4 TL 55.3 | 1 - 1.2 1 - 1.5 1 - 2.8 | \emptyset 17.000 TL 65.00 | | | | TEIKIN NO. |
|  | TEIKIN NO. 45126-4 | TEIKIN NO. P 45125 | | | | | |
| Surface Treatment Tin Coated Bore Clearance MRC: 0.030 mm MP: 13.50 mm | REFERENCE NO. 12111-82010 | | | | | | |
| | | | | | | | |
| G13 NEW 993 cc 4 cyl. GM METRO F.I., SOHC 6 V 1989-2000 | \emptyset 74.00 -2.1 CD 28.7 TL 55.7 | 1 - 1.2 1 - 1.5 1 - 2.8 | \emptyset 17.000 TL 65.00 | | | | TEIKIN NO. |
|  | TEIKIN NO. 45125-4 | TEIKIN NO. P 45125 | | | | | |
| Surface Treatment Tin Coated Bore Clearance MRC: 0.030 mm MP: 13.80 mm | REFERENCE NO. 12111-60B00-0B0 12111-61810-0B0 96060039 | | | | | | |
| | | | | | | | |

| ENGINE TYPE | PISTON | PISTON RING | PISTON PIN | PIN BUSHING | LINER | | LINER KIT SET |
|--|---|-------------------------------|--|-------------|---------|-----------|---------------|
| | | | | | FLANGED | NO FLANGE | |
| G13B 1300 cc 4 cyl.  Surface Treatment Bore Clearance Tin Coated MRC: 0.030 mm MP: 13.50 mm | Ø 74.00 -4.8 CD 29.3 TL 56.2 | 1 - 1.2 1 - 1.5 1 - 2.8 | Ø 17.000 TL 65.00 | | | | TEIKIN NO. |
| | TEIKIN NO. 45128 | | TEIKIN NO. P 45125 | | | | |
| | REFERENCE NO. 12111-63B00-0B0 12111-61840-0B0 | | | | | | |
| | | | | | | | 17 |
| G13BB 1298 cc 4 cyl. JIMMY, CARRY VAN SOHC 16V 1998 - ON  Surface Treatment Bore Clearance Tin Coated MRC: 0.030 mm MP: 15.30 mm | Ø 74.00 -1.9 CD 29.0 TL 56.0 | 1 - 1.2 1 - 1.5 1 - 2.8 | Ø 19.000 TL 61.00  | | | | TEIKIN NO. |
| | TEIKIN NO. 45653 | | TEIKIN NO. P 45127 | | | | |
| | REFERENCE NO. | | | | | | |
| | | | | | | | 18 |
| G13B-II 1298 cc 4 cyl.  Surface Treatment Bore Clearance None MRC: 0.030 mm MP: 14.00 mm | Ø 74.00 CD 29.2 TL 56.2 | 1 - 1.2 1 - 1.5 1 - 2.8 | Ø 19.000 TL 61.00  | | | | TEIKIN NO. |
| | TEIKIN NO. 45654 | | TEIKIN NO. P 45127 | | | | |
| | REFERENCE NO. 12111-86501 | | | | | | |
| | | | | | | | 19 |
| G13-II 1298 cc 4 cyl.  Surface Treatment Bore Clearance Tin Coated MRC: 0.030 mm MP: 13.80 mm | Ø 74.00 -1.6 CD 28.4 TL 55.4 | 1 - 1.2 1 - 1.5 1 - 2.8 | Ø 17.000 TL 65.00 | | | | TEIKIN NO. |
| | TEIKIN NO. 45650 | | TEIKIN NO. P 45125 | | | | |
| | REFERENCE NO. 12111-83000 | | | | | | |
| | | | | | | | 20 |

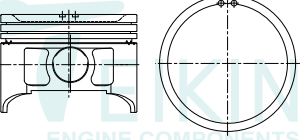
| ENGINE TYPE | PISTON | PISTON RING | PISTON PIN | PIN BUSHING | LINER | | LINER KIT SET | |
|---|--|-------------------------------|------------------------------------|-------------|---------|-----------|--|--|
| | | | | | FLANGED | NO FLANGE | | |
| G13-Y58 1298 cc 4 cyl. Surface Treatment Bore Clearance Tin Coated MRC: 0.030 mm MP: 15.30 mm | \emptyset 74.00 -1.9 CD 29.0 TL 56.0 | 2 - 1.2 1 - 2.5 | \emptyset 19.000 TL 61.00 | | | | TEIKIN NO. 45655 REFERENCE NO. 12111-63E10 12100-63880 | |
| | TEIKIN NO. | TEIKIN NO. | | | | | | |
| | TEIKIN NO. | P 45127 | | | | | | |
| | | | | | | | | |
| | | | | | | | 21 | |
| STEAM 1.3L 4 cyl. Surface Treatment Bore Clearance None MRC: 0.030 mm MP: 15.30 mm | \emptyset 74.00 -3.0 CD 29.0 TL 56.0 | 2 - 1.2 1 - 2.5 | \emptyset 19.000 TL 61.00 | | | | TEIKIN NO. 45135 REFERENCE NO. 12101-63810-0A0 | |
| | TEIKIN NO. | TEIKIN NO. | | | | | | |
| | TEIKIN NO. | P 45127 | | | | | | |
| | | | | | | | | |
| | | | | | | | 22 | |
| G15A 1493 cc 4 cyl. Surface Treatment Bore Clearance None MRC: 0.030 mm MP: 13.50 mm | \emptyset 75.00 -4.1 CD 28.3 TL 55.3 | 2 - 1.2 1 - 2.5 | \emptyset 19.000 TL 62.00 | | | | TEIKIN NO. 45149 REFERENCE NO. 12111-61J00-0B0 | |
| | TEIKIN NO. | TEIKIN NO. | | | | | | |
| | TEIKIN NO. | P 44259 | | | | | | |
| | | | | | | | | |
| | | | | | | | 23 | |
| G16A, G16KC 1590 cc 4 cyl. SL413-II SIDEKICK 1989-95 GM TRACKER 1989-95 F.I.,SOHC, 8 V Surface Treatment Bore Clearance None MRC: 0.030 mm MP: 16.40 mm | \emptyset 75.00 -3.4 CD 28.4 TL 58.4 | 1 - 1.2 1 - 1.5 1 - 2.8 | \emptyset 19.000 TL 61.00 | | | | TEIKIN NO. 45127 REFERENCE NO. 12111-60A02-0A0 | |
| | TEIKIN NO. | TEIKIN NO. | | | | | | |
| | TEIKIN NO. | P 45127 | | | | | | |
| | | | | | | | | |
| | | | | | | | 24 | |

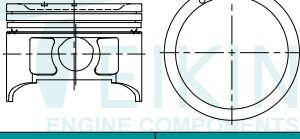
| ENGINE TYPE | PISTON | PISTON RING | PISTON PIN | PIN BUSHING | LINER | | LINER KIT SET |
|--|--|-------------------------------|------------------------------------|-------------|---------|-----------|---------------|
| | | | | | FLANGED | NO FLANGE | |
| G16B-II BALENO 4 cyl. | \emptyset 75.00 -6.3 CD 28.4 TL 55.4 | 2 - 1.2 1 - 2.5 | \emptyset 19.000 TL 62.00 | | | | TEIKIN NO. |
| TEIKIN NO. 45144 | | | TEIKIN NO. P 44259 | | | | |
| Surface Treatment None Bore Clearance MRC: 0.030 mm MP: 15.50 mm | REFERENCE NO. 12100-61860 | | | | | | 25 |
| G16KV SIDEKICK GM TRACKER F.I., SOHC, 16 V 1991-98 1590 cc 4 cyl. | \emptyset 75.00 -4.1 CD 28.5 TL 55.3 | 1 - 1.2 1 - 1.5 1 - 2.8 | \emptyset 19.000 TL 62.00 | | | | TEIKIN NO. |
| TEIKIN NO. 45124 | | | TEIKIN NO. P 44259 | | | | |
| Surface Treatment Tin Coated Bore Clearance MRC: 0.020 mm MP: 13.50 mm | REFERENCE NO. 12111-61850 12100-71820 | | | | | | 26 |
| SL413 FUTURA 1300 cc 4 cyl. | \emptyset 75.00 -1.4 CD 28.4 TL 58.3 | 1 - 1.2 1 - 1.5 1 - 2.8 | \emptyset 19.000 TL 64.00 | | | | TEIKIN NO. |
| TEIKIN NO. 45123 | | | TEIKIN NO. P 43132 | | | | |
| Surface Treatment None Bore Clearance MRC: 0.030 mm MP: 16.40 mm | REFERENCE NO. 12111-77500-0A0 | | | | | | 27 |
| SWIFT 1.6 G16 1590 cc 4 cyl. | \emptyset 75.00 -6.3 CD 28.4 TL 55.4 | 1 - 1.2 1 - 1.5 1 - 2.8 | \emptyset 19.000 TL 62.00 | | | | TEIKIN NO. |
| TEIKIN NO. 45601 (45130) | | | TEIKIN NO. P 44259 | | | | |
| Surface Treatment Tin Coated Bore Clearance MRC: 0.030 mm MP: 15.50 mm | REFERENCE NO. 12111-71C50 12111-71C51 | | | | | | 28 |



| ENGINE TYPE | PISTON | PISTON RING | PISTON PIN | PIN BUSHING | LINER | | LINER KIT SET |
|---|--|-------------------------------|---|-------------|---------|-----------|--|
| | | | | | FLANGED | NO FLANGE | |
| H20A 6 cyl.  Surface Treatment: None Bore Clearance: MRC: 0.030 mm, MP: 15.00 mm | \varnothing 78.00 -2.9 CD 29.4 TL 58.9 | 1 - 1.2 1 - 1.5 1 - 2.5 | \varnothing 20.000 TL 59.00  | | | | TEIKIN NO. REFERENCE NO. 12111-85FA2 33 |
| | TEIKIN NO. 45134 | TEIKIN NO. P 51101 | | | | | |
| | TEIKIN NO. | TEIKIN NO. | | | | | |
| | REFERENCE NO. 12111-85FA2 | | | | | | |
| J20A 1995 cc 4 cyl. VITARA 1999-2002 F.I., DOHC 16V  Surface Treatment: None Bore Clearance: MRC: 0.030 mm, MP: 16.00 mm | \varnothing 84.00 -4.9 CD 29.4 TL 58.9 | 1 - 1.2 1 - 1.5 1 - 2.5 | \varnothing 21.000 TL 59.00  | | | | TEIKIN NO. REFERENCE NO. 12100-65810/1 34 |
| | TEIKIN NO. 45133 | TEIKIN NO. P 45131 | | | | | |
| | TEIKIN NO. | TEIKIN NO. | | | | | |
| | REFERENCE NO. 12100-65810/1 | | | | | | |
| J20A-II 4 cyl.  Surface Treatment: Anodized Crown, 1st Ring Anodized Bore Clearance: MRC: 0.030 mm, MP: 14.50 mm | \varnothing 84.00 -4.4 CD 31.0 TL 60.5 | 2 - 1.2 1 - 2.5 | \varnothing 21.000 TL 59.00  | | | | TEIKIN NO. REFERENCE NO. 12100-65831-0A0 35 |
| | TEIKIN NO. 45150 | TEIKIN NO. P 45131 | | | | | |
| | TEIKIN NO. | TEIKIN NO. | | | | | |
| | REFERENCE NO. 12100-65831-0A0 | | | | | | |
| SX4 4 cyl.  Surface Treatment: Anodized Crown, 1st Ring Anodized Bore Clearance: MRC: 0.030 mm, MP: 14.50 mm | \varnothing 84.00 -3.6 CD 31.2 TL 60.7 | 2 - 1.2 1 - 2.5 | \varnothing 21.000 TL 59.00  | | | | TEIKIN NO. REFERENCE NO. 12100-65820-0A0 36 |
| | TEIKIN NO. 45147 | TEIKIN NO. P 45131 | | | | | |
| | TEIKIN NO. | TEIKIN NO. | | | | | |
| | REFERENCE NO. 12100-65820-0A0 | | | | | | |

SUITABLE FOR

SUZUKI

GASOLINE

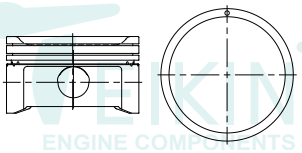

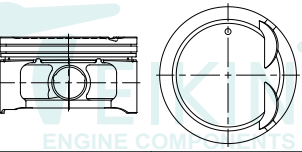
| ENGINE TYPE | PISTON | PISTON RING | PISTON PIN | PIN BUSHING | LINER | | LINER KIT SET |
|--|--|---|---|-------------|---------|-----------|---------------|
| | | | | | FLANGED | NO FLANGE | |
| AERIO 2290 cc DOHC 16V 2004-2007 4 cyl. | \varnothing 90.00 -5.7 CD 31.1 TL 52.1 | 2 - 1.2 1 - 2.5 | \varnothing 21.000 TL 59.00  | | | | TEIKIN NO. |
|  | TEIKIN NO. 45140 | | TEIKIN NO. P 45131 | | | | |
| Surface Treatment Moly Skirt Anodized Crown 1st Ring Anodized | Bore Clearance MRC: 0.030 mm MP: 7.50 mm | REFERENCE NO. 12100-598-100A0 | | | | | 41 |
| J24B 2400 cc 4 cyl. | \varnothing 92.00 -0.9 CD 30.7 TL 51.2 | 1 - 1.2 1 - 1.0 1 - 2.0 | \varnothing 21.000 TL 59.00  | | | | TEIKIN NO. |
|  | TEIKIN NO. 45139 | | TEIKIN NO. P 45131 | | | | |
| Surface Treatment Moly Skirt Anodized Crown 1st Ring Anodized | Bore Clearance MRC: 0.030 mm MP: 6.00 mm | REFERENCE NO. 12100-78831-0A0 | | | | | 42 |

S

| ENGINE TYPE | PISTON | PISTON RING | PISTON PIN | PIN BUSHING | LINER | | LINER KIT SET |
|--|--|-------------------------------|------------------------------|------------------------------|--|-----------|------------------------------------|
| | | | | | FLANGED | NO FLANGE | |
| ACE 2 cyl. | Ø 75.00 -1.4 CD 43.0 TL 69.1 | 2 - 2.0 1 - 3.0 | Ø 23.010 TL 56.50 | | TL 134.0 OD 78.1 FT 5.0 FD 78.8 | | TEIKIN NO. LKSF 62101A-2 |
| Surface Treatment Moly Skirt Anodized Crown | Bore Clearance MRC: 0.060 mm MP: 12.00 mm | TEIKIN NO. 62101A-2 | TEIKIN NO. P 62101 | TEIKIN NO. B 62101 | TEIKIN NO. LSF 62101 | | 1 |
| REFERENCE NO. 279003990109N | | REFERENCE NO. | | REFERENCE NO. | | | |
| ACE-II 2 cyl. | Ø 75.00 -1.2 CD 43.0 TL 69.0 | 2 - 2.0 1 - 3.0 | Ø 23.010 TL 56.50 | | TL 134.0 OD 78.1 FT 5.0 FD 78.8 | | |
| Surface Treatment Chromated Moly Skirt | Bore Clearance MRC: 0.030 mm MP: 11.50 mm | TEIKIN NO. 62104A-2 | TEIKIN NO. P 62101 | TEIKIN NO. B 62101 | TEIKIN NO. LSF 62101 | | 2 |
| REFERENCE NO. | | REFERENCE NO. | | REFERENCE NO. | | | |
| INDICA 4 cyl. | Ø 75.00 -1.4 CD 43.0 TL 69.1 | 2 - 2.0 1 - 3.0 | Ø 23.010 TL 56.50 | | TL 134.0 OD 78.1 FT 5.0 FD 78.8 | | |
| Surface Treatment Moly Skirt Anodized Crown | Bore Clearance MRC: 0.060 mm MP: 12.00 mm | TEIKIN NO. 62101A | TEIKIN NO. P 62101 | TEIKIN NO. B 62101 | TEIKIN NO. LSF 62101 | | 3 |
| REFERENCE NO. 279003990109N | | REFERENCE NO. | | REFERENCE NO. | | | |
| 207 4 cyl. | Ø 83.00 -2.3 CD 46.8 TL 84.3 | 2 - 2.0 1 - 3.0 | Ø 25.000 TL 70.00 | | | | |
| Surface Treatment Chromated Moly Skirt | Bore Clearance MRC: 0.050 mm MP: 18.00 mm | TEIKIN NO. 62103A | TEIKIN NO. P G0118 | | | | 4 |
| REFERENCE NO. | | REFERENCE NO. | | REFERENCE NO. | | | |

T

SUITABLE FOR

TATA

DIESEL

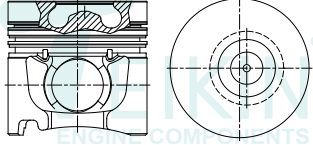

| ENGINE TYPE | PISTON | PISTON RING | PISTON PIN | PIN BUSHING | LINER | | LINER KIT SET |
|---|---|--|---|------------------------------|---|-----------|----------------------------------|
| | | | | | FLANGED | NO FLANGE | |
| 407 TURBO 4 cyl. | \varnothing 97.00 -18.7 CD 58.5 TL 93.4 | 1 - 2.5 FK 1 - 2.5 1 - 4.0 | \varnothing 36.000 TL 79.00  | | TL 176.5 OD 100.1 4.6 FD 103.5 | | TEIKIN NO. LKSF 62102A |
|  | TEIKIN NO. 62102A | | TEIKIN NO. P 39181 | TEIKIN NO. B 62102 | TEIKIN NO. LSF 62102 | | 5 |
| Surface Treatment Chromated Moly Skirt | Bore Clearance MRC: 0.090 mm MP: 10.40 mm | REFERENCE NO. 8854 0356 2534 | | REFERENCE NO. | REFERENCE NO. | | |

T

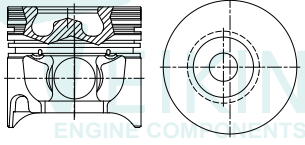
| ENGINE TYPE | PISTON | PISTON RING | PISTON PIN | PIN BUSHING | LINER | | LINER KIT SET |
|---|---|-------------------------------|---|-------------|---------|-----------|-------------------|
| | | | | | FLANGED | NO FLANGE | |
| TRAVELLER 4 cyl. | \varnothing 90.90 -20 CD 48.6 TL 82.1 | 1 - 3.0 1 - 2.0 1 - 4.0 | \varnothing 28.000 TL 76.80  | | | | TEIKIN NO. |
|  | TEIKIN NO. 68101A | | TEIKIN NO. P 43157 | | | | |
| Surface Treatment Chromated | Bore Clearance MRC: 0.060 mm MP: 14.00 mm | REFERENCE NO. | | | | | 1 |

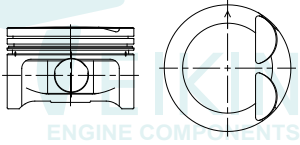
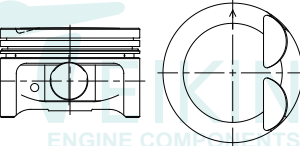
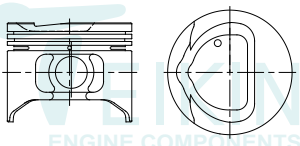
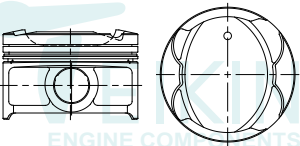
| ENGINE TYPE | PISTON | PISTON RING | PISTON PIN | PIN BUSHING | LINER | | LINER KIT SET |
|---|---|------------------------|--------------------------------|-------------|---------|-----------|---------------|
| | | | | | FLANGED | NO FLANGE | |
| 1SZFE 998 cc 4 cyl. YARIS DOHC 16V 1998-2002 | \emptyset 69.00 +0.3 CD 26.1 TL 44.6 | 2 - 1.2 1 - 2.0 | \emptyset 18.000 TL 47.50 | | | | TEIKIN NO. |
|  | TEIKIN NO. 46341 | | TEIKIN NO. P 30110 | | | | |
| Surface Treatment Bore Clearance Tin Coated MRC: 0.030 mm MP: 5.75 mm | REFERENCE NO. 13101-0J010 | | | | | | |
| | | | | | | | 1 |
| 1SZFE-II 998 cc 4 cyl. | \emptyset 69.00 +0.3 CD 26.1 TL 44.4 | 2 - 1.2 1 - 2.0 | \emptyset 18.000 TL 47.50 | | | | TEIKIN NO. |
|  | TEIKIN NO. 46385 | | TEIKIN NO. P 30110 | | | | |
| Surface Treatment Bore Clearance Tin Coated MRC: 0.030 mm MP: 5.75 mm | REFERENCE NO. 13101-23020 | | | | | | |
| | | | | | | | 2 |
| 1E, 1EL 999 cc 4 cyl. | \emptyset 70.50 -4.40 CD 28.0 TL 56.0 | 2 - 1.5 1 - 3.0 | \emptyset 18.000 TL 53.00 | | | | TEIKIN NO. |
|  | TEIKIN NO. 46661 | | TEIKIN NO. P 46332 | | | | |
| Surface Treatment Bore Clearance Tin Coated MRC: 0.030 mm MP: 14.90 mm | REFERENCE NO. 13101-10033 | | | | | | |
| | | | | | | | 3 |
| 1KR-FE 998 cc 3 cyl. AYGO-PASSO VITZ-YARIS KGB10-KSP90 DOHC 12V | \emptyset 71.00 +2.5 CD 26.7 TL 47.0 | 2 - 1.0 1 - 1.5 | \emptyset 18.000 TL 47.50 | | | | TEIKIN NO. |
|  | TEIKIN NO. 46677 | | TEIKIN NO. P 30110 | | | | |
| Surface Treatment Bore Clearance Moly Skirt MRC: 0.030 mm MP: 5.00 mm | REFERENCE NO. 13101-40020 13101-40021 | | | | | | |
| | | | | | | | 4 |

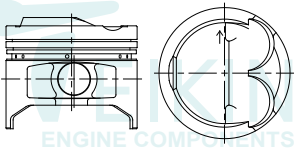
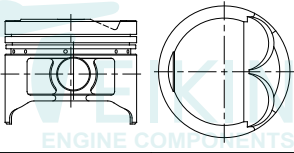
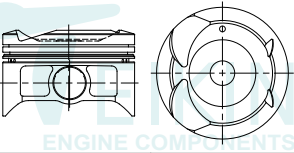
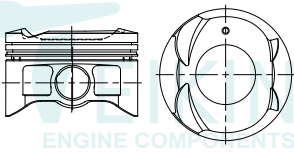

T

| ENGINE TYPE | PISTON | PISTON RING | PISTON PIN | PIN BUSHING | LINER | | LINER KIT SET |
|---|--|--------------------|-----------------------------|-------------|---------|-----------|---------------|
| | | | | | FLANGED | NO FLANGE | |
| 3NR-FE 4 cyl. Surface Treatment: Moly Skirt, Anodized Crown, 1st Ring Anodized Bore Clearance: MRC: 0.030 mm, MP: 5.00 mm | Ø 72.50 +3.3 CD 30.0 TL 49.8 | 2 - 1.0 1 - 2.0 | Ø 18.000 TL 53.00 | | | | TEIKIN NO. |
| | TEIKIN NO. 46387 | | TEIKIN NO. P 46332 | | | | |
| | REFERENCE NO. 13101-0Y030 | | | | | | |
| | | | | | | | 9 |
| 2E 1295 cc 4 cyl. 1984 Surface Treatment: Tin Coated Bore Clearance: MRC: 0.030 mm, MP: 16.55 mm | Ø 73.00 -9.0 CD 30.0 TL 58.0 | 2 - 1.5 1 - 3.0 | Ø 18.000 TL 59.00 | | | | TEIKIN NO. |
| | TEIKIN NO. 46141 | | TEIKIN NO. P 46141 | | | | |
| | REFERENCE NO. 13101-11050 13101-11051 | | | | | | |
| | | | | | | | 10 |
| 2E-II 1295 cc 4 cyl. Surface Treatment: Tin Coated Bore Clearance: MRC: 0.030 mm, MP: 16.55 mm | Ø 73.00 -8.0 CD 30.0 TL 58.0 | 2 - 1.5 1 - 3.0 | Ø 18.000 TL 59.00 | | | | TEIKIN NO. |
| | TEIKIN NO. 46345 | | TEIKIN NO. P 46141 | | | | |
| | REFERENCE NO. 13101-11030 13101-11090 | | | | | | |
| | | | | | | | 11 |
| 3E, 3EE 1456 cc 4 cyl. SOHC, 12 V, CARB TERCEL 1986-94 Surface Treatment: Tin Coated Bore Clearance: MRC: 0.030 mm, MP: 19.50 mm | Ø 73.00 -3.4 CD 30.0 TL 62.0 | 2 - 1.5 1 - 3.0 | Ø 18.000 TL 59.00 | | | | TEIKIN NO. |
| | TEIKIN NO. 46274 | | TEIKIN NO. P 46141 | | | | |
| | REFERENCE NO. 13101-11081 | | | | | | |
| | | | | | | | 12 |

| ENGINE TYPE | PISTON | PISTON RING | PISTON PIN | PIN BUSHING | LINER | | LINER KIT SET |
|---|---|------------------------|-----------------------|-------------|---------|-----------|---------------|
| | | | | | FLANGED | NO FLANGE | |
| 4E-FE-II 1331 cc 4 cyl.  Surface Treatment: Tin Coated Bore Clearance: MRC: 0.030 mm, MP: 15.00 mm | Ø 74.00 +4.7 CD 30.0 TL 62.8 | 2 - 1.2 1 - 3.0 | Ø 18.000 TL 59.00 | | | | TEIKIN NO. |
| | TEIKIN NO. 46346 | | TEIKIN NO. P 46141 | | | | |
| | REFERENCE NO. 13101-11101 | | | | | | |
| | | | | | | | 13 |
| 5E-FE 1497 cc 4 cyl. TERCEL, 16 V, 1995-98 PASEO, 16 V, 1992-95  Surface Treatment: Tin Coated Bore Clearance: MRC: 0.020 mm, MP: 14.60 mm | Ø 74.00 +0.8 CD 30.0 TL 58.9 | 2 - 1.2 1 - 3.0 | Ø 18.000 TL 59.00 | | | | TEIKIN NO. |
| | TEIKIN NO. 46258 | | TEIKIN NO. P 46141 | | | | |
| | REFERENCE NO. 13101-11131 13101-11161 | | | | | | |
| | | | | | | | 14 |
| 1NZFE 1496 cc 4 cyl. F.I., DOHC ECHO 2000-01  Surface Treatment: Tin Coated Bore Clearance: MRC: 0.030 mm, MP: 8.50 mm | Ø 75.00 +2.0 CD 28.0 TL 48.8 | 2 - 1.2 1 - 2.0 | Ø 18.000 TL 53.00 | | | | TEIKIN NO. |
| | TEIKIN NO. 46332 | | TEIKIN NO. P 46332 | | | | |
| | REFERENCE NO. 13101-21030 | | | | | | |
| | | | | | | | 15 |
| 1NZFE-II 1500 cc 4 cyl.  Surface Treatment: Tin Coated Bore Clearance: MRC: 0.030 mm, MP: 8.50 mm | Ø 75.00 +2.5 CD 28.3 TL 49.8 | 2 - 1.2 1 - 2.0 | Ø 18.000 TL 53.00 | | | | TEIKIN NO. |
| | TEIKIN NO. 46364 | | TEIKIN NO. P 46332 | | | | |
| | REFERENCE NO. 13101-21070 | | | | | | |
| | | | | | | | 16 |



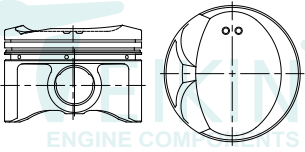
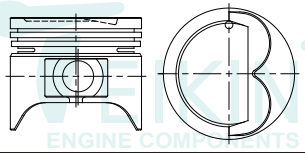
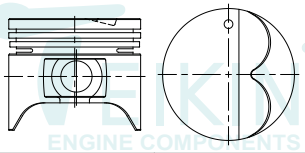
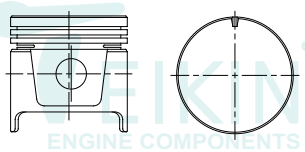

T





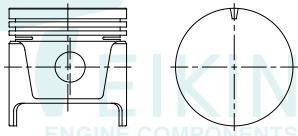

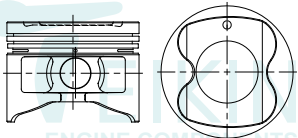
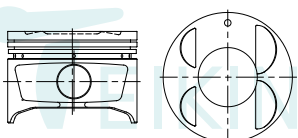
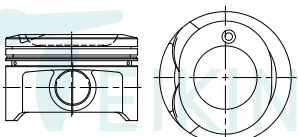

| ENGINE TYPE | PISTON | PISTON RING | PISTON PIN | PIN BUSHING | LINER | | LINER KIT SET |
|--|--|-------------------------------|-------------------------------------|-------------|---------|-----------|---------------|
| | | | | | FLANGED | NO FLANGE | |
| 1NZFE-III 4 cyl. | \emptyset 75.00 +2.5 CD 28.2 TL 47.7 | 1 - 1.0 1 - 1.2 1 - 1.5 | \emptyset 18.000 TL 53.00 | | | | TEIKIN NO. |
| ENGINE COMPONENTS | TEIKIN NO. 46371 | | TEIKIN NO. P 46332 | | | | |
| Surface Treatment Anodized Crown Moly Skirt | Bore Clearance MRC: 0.030 mm MP: 8.50 mm | | REFERENCE NO. 13101-21090 | | | | |
| | | | | | | | 17 |
| 1NZ-FXE 1496 cc 4 cyl. | \emptyset 75.00 +2.5 CD 28.2 TL 47.9 | 1 - 1.0 1 - 1.2 1 - 2.0 | \emptyset 18.000 TL 53.00 | | | | TEIKIN NO. |
| ENGINE COMPONENTS | TEIKIN NO. 46370 | | TEIKIN NO. P 46332 | | | | |
| Surface Treatment Anodized Crown Moly Skirt | Bore Clearance MRC: 0.030 mm MP: 8.50 mm | | REFERENCE NO. 13101-21120 | | | | |
| | | | | | | | 18 |
| 2NZ-FE 4 cyl. | \emptyset 75.00 -3.8 CD 30.0 TL 47.2 | 2 - 1.2 1 - 3.0 | \emptyset 18.000 TL 53.00 | | | | TEIKIN NO. |
| ENGINE COMPONENTS | TEIKIN NO. 46354 | | TEIKIN NO. P 46332 | | | | |
| Surface Treatment Tin Coated | Bore Clearance MRC: 0.030 mm MP: 8.75 mm | | REFERENCE NO. 13101-21050 | | | | |
| | | | | | | | 19 |
| 2NZ-FE-II 4 cyl. | \emptyset 75.00 -2.8 CD 30.0 TL 47.2 | 2 - 1.2 1 - 2.0 | \emptyset 18.000 TL 53.00 | | | | TEIKIN NO. |
| ENGINE COMPONENTS | TEIKIN NO. 46355 | | TEIKIN NO. P 46332 | | | | |
| Surface Treatment Tin Coated | Bore Clearance MRC: 0.030 mm MP: 8.70 mm | | REFERENCE NO. 13101-21040 | | | | |
| | | | | | | | 20 |

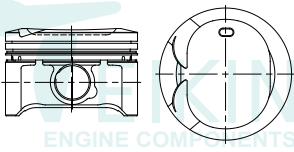
| ENGINE TYPE | PISTON | PISTON RING | PISTON PIN | PIN BUSHING | LINER | | LINER KIT SET |
|--|---|--------------------|---|-------------|---------|-----------|---------------|
| | | | | | FLANGED | NO FLANGE | |
| 1G-FE cc 6 cyl.  Surface Treatment: Moly Skirt, Anodized Crown Bore Clearance: MRC: 0.030 mm, MP: 7.20 mm | \emptyset 75.00 +2.5 CD 30.3 TL 52.8 | 2 - 1.2 1 - 3.0 | \emptyset 20.012 TL 56.58 | | | | TEIKIN NO. |
| | TEIKIN NO. 46377 | | TEIKIN NO. P 46340 | | | | |
| | REFERENCE NO. 13101-70120 | | | | | | |
| | | | | | | | 25 |
| 2A 1295 cc 4 cyl. 1982-ON  Surface Treatment: Tin Coated Bore Clearance: MRC: 0.050 mm, MP: 17.50 mm | \emptyset 76.00 -2.1 CD 34.0 TL 65.0 | 2 - 2.0 1 - 4.0 | \emptyset 18.000 TL 61.00 | | | | TEIKIN NO. |
| | TEIKIN NO. 46604 (46299) | | TEIKIN NO. P 43187 | | | | |
| | REFERENCE NO. 13101-14020 | | | | | | |
| | | | | | | | 26 |
| 2A-II 1295 cc 4 cyl. TERCWL AL11 SOHC 8V  Surface Treatment: Tin Coated Bore Clearance: MRC: 0.050 mm, MP: 17.50 mm | \emptyset 76.00 -3.9 CD 33.3 TL 64.3 | 2 - 2.0 1 - 4.0 | \emptyset 18.000 TL 61.00 | | | | TEIKIN NO. |
| | TEIKIN NO. 46687 | | TEIKIN NO. P 43187 | | | | |
| | REFERENCE NO. 13101-14010 13103-14010 13104-14010 13105-14010 | | | | | | |
| | | | | | | | 27 |
| 3P 1345 cc 4 cyl.  Surface Treatment: Tin Coated Bore Clearance: MRC: 0.035 mm, MP: 13.50 mm | \emptyset 76.60 CD 38.0 TL 76.0 | 2 - 2.0 1 - 4.0 | \emptyset 20.000 TL 65.00  | | | | TEIKIN NO. |
| | TEIKIN NO. 46615 (46314) | | TEIKIN NO. P 56101 | | | | |
| | REFERENCE NO. 13101-23010 13101-23011 | | | | | | |
| | | | | | | | 28 |

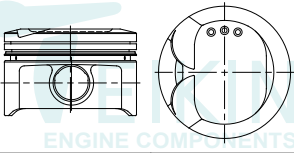
| ENGINE TYPE | PISTON | PISTON RING | PISTON PIN | PIN BUSHING | LINER | | LINER KIT SET |
|--|--|------------------------|------------------------------------|-------------|---------|-----------|--|
| | | | | | FLANGED | NO FLANGE | |
| 4P(High) 1493 cc 4 cyl. Surface Treatment Tin Coated Bore Clearance MRC: 0.030 mm MP: 22.00 mm | \emptyset 76.60 CD 33.0 TL 71.0 | 2 - 2.0 1 - 4.0 | \emptyset 20.000 TL 65.00 | | | | TEIKIN NO. REFERENCE NO. 13101-96001 13101-78001 29 |
| | TEIKIN NO. 46612 (46305) | | TEIKIN NO. P 56101 | | | | |
| | | | | | | | |
| | | | | | | | |
| 4P(Low) 1493 cc 4 cyl. Surface Treatment Tin Coated Bore Clearance MRC: 0.020 mm MP: 15.00 mm | \emptyset 76.60 CD 34.4 TL 72.4 | 2 - 2.0 1 - 4.0 | \emptyset 20.000 TL 65.00 | | | | TEIKIN NO. REFERENCE NO. 30 |
| | TEIKIN NO. 46651 | | TEIKIN NO. P 56101 | | | | |
| | | | | | | | |
| | | | | | | | |
| 1A 1452 cc 1AC, 1AU 4 cyl. Surface Treatment Tin Coated Bore Clearance MRC: 0.010 mm MP: 10.00 mm | \emptyset 77.50 CD 31.0 TL 61.0 | 2 - 1.5 1 - 2.8 | \emptyset 18.000 TL 61.00 | | | | TEIKIN NO. REFERENCE NO. 13101-15010 31 |
| | TEIKIN NO. 46658 | | TEIKIN NO. P 43187 | | | | |
| | | | | | | | |
| | | | | | | | |
| 3A, 3AU 1452 cc TERCEL CORSA SPRINTER 1979 4 cyl. Surface Treatment None Bore Clearance MRC: 0.030 mm MP: 15.00 mm | \emptyset 77.50 CD 31.0 TL 60.9 | 2 - 1.5 1 - 2.8 | \emptyset 18.000 TL 61.00 | | | | TEIKIN NO. REFERENCE NO. 13101-15020 32 |
| | TEIKIN NO. 46163 | | TEIKIN NO. P 43187 | | | | |
| | | | | | | | |
| | | | | | | | |

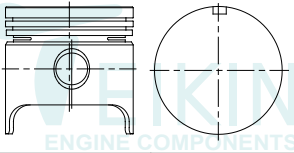
T

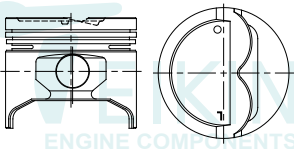
| ENGINE TYPE | PISTON | PISTON RING | PISTON PIN | PIN BUSHING | LINER | | LINER KIT SET |
|--|--|-------------------------------|--|-------------|---------|-----------|---------------|
| | | | | | FLANGED | NO FLANGE | |
| 2R 1490 cc 4 cyl.  Surface Treatment Bore Clearance Tin Coated MRC: 0.020 mm MP: 25.00 mm | Ø 78.00 CD 39.7 TL 78.0 | 1 - 2.0 1 - 2.5 1 - 4.0 | Ø 20.000 TL 66.00  | | | | TEIKIN NO. |
| | TEIKIN NO. 46614 (46307) | | TEIKIN NO. P 46187 | | | | |
| | REFERENCE NO. 13101-31011 13101-31010 | | | | | | |
| | | | | | | | 33 |
| 5AF 1498 cc 4 cyl.  Surface Treatment Bore Clearance Tin Coated MRC: 0.030 mm Anodized Crown MP: 14.50 mm | Ø 78.70 CD 30.5 TL 59.5 | 2 - 1.5 1 - 3.0 | Ø 18.000 TL 61.00 | | | | TEIKIN NO. |
| | TEIKIN NO. 46290 | | TEIKIN NO. P 43187 | | | | |
| | REFERENCE NO. 13101-15040 | | | | | | |
| | | | | | | | 34 |
| 5AFE NEW 1498 cc 4 cyl.  Surface Treatment Bore Clearance Tin Coated MRC: 0.030 mm MP: 11.00 mm | Ø 78.70 CD 30.5 TL 55.6 | 1 - 1.2 1 - 1.5 1 - 3.0 | Ø 20.012 TL 56.58 | | | | TEIKIN NO. |
| | TEIKIN NO. 46347 | | TEIKIN NO. P 46340 | | | | |
| | REFERENCE NO. 13101-15050 | | | | | | |
| | | | | | | | 35 |
| 1ZZFE 1794 cc 4 cyl. COROLLA CELICA, MR2, MATRIX 2000-02 F.I., DOHC 16 V  Surface Treatment Bore Clearance Anodized Crown MRC: 0.030 mm Moly Skirt MP: 5.00 mm | Ø 79.00 CD 30.0 TL 51.7 | 2 - 1.2 1 - 3.0 | Ø 20.012 TL 50.00  | | | | TEIKIN NO. |
| | TEIKIN NO. 46334 | | TEIKIN NO. P 46334 | | | | |
| | REFERENCE NO. 13101-22140 13101-22020 13101-22030 13101-22031/60 | | | | | | |
| | | | | | | | 36 |

| ENGINE TYPE | PISTON | PISTON RING | PISTON PIN | PIN BUSHING | LINER | | LINER KIT SET |
|--|--|------------------------|--|-------------|---------|-----------|---------------|
| | | | | | FLANGED | NO FLANGE | |
| 3ZZ-FE 1598 cc 4 cyl.  Surface Treatment Tin Coated Anodized Crown Bore Clearance MRC: 0.030 mm MP: 7.50 mm | Ø 79.00 +2.3 CD 29.9 TL 52.2 | 2 - 1.2 1 - 3.0 | Ø 20.012 TL 50.00  | | | | TEIKIN NO. |
| | TEIKIN NO. 46367 | | TEIKIN NO. P 46334 | | | | |
| | REFERENCE NO. 13101-0D071 13101-0D070 13101-0D111 | | | | | | 37 |
| 4ZZFE 1398 cc 4 cyl. COROLLA DOHC 16V 1999-ON  Surface Treatment Tin Coated Anodized Crown Bore Clearance MRC: 0.030 mm MP: 5.00 mm | Ø 79.00 +2.2 CD 30.0 TL 51.7 | 2 - 1.2 1 - 3.0 | Ø 20.012 TL 50.00  | | | | TEIKIN NO. |
| | TEIKIN NO. 46342 | | TEIKIN NO. P 46334 | | | | |
| | REFERENCE NO. 13101-22071 13101-22051 | | | | | | 38 |
| 12R, 12RU 1587 cc 4 cyl. HI-LUX, TOYO-ACE HI-ACE 1971  Surface Treatment Tin Coated Bore Clearance MRC: 0.030 mm MP: 23.00 mm | Ø 80.50 CD 39.0 TL 79.9 | 2 - 2.0 1 - 4.0 | Ø 20.000 TL 66.00  | | | | TEIKIN NO. |
| | TEIKIN NO. 46187 | | TEIKIN NO. P 46187 | | | | |
| | REFERENCE NO. 13101-31020 13101-31021 13101-31022 | | | | | | 39 |
| 1S 1832 cc 4 cyl.  Surface Treatment Tin Coated Bore Clearance MRC: 0.030 mm MP: 20.50 mm | Ø 80.50 -2.0 CD 33.0 TL 68.0 | 2 - 1.5 1 - 4.0 | Ø 20.000 TL 66.00  | | | | TEIKIN NO. |
| | TEIKIN NO. 46116 | | TEIKIN NO. P 46187 | | | | |
| | REFERENCE NO. 13101-63020 13101-63010 13101-63011 | | | | | | 40 |

T

| ENGINE TYPE | PISTON | PISTON RING | PISTON PIN | PIN BUSHING | LINER | | LINER KIT SET |
|---|---|-------------------------------|--------------------------------------|-------------|---------|-----------|---------------|
| | | | | | FLANGED | NO FLANGE | |
| 1ZR-FE 4 cyl. | \varnothing 80.50 +2.5 CD 33.4 TL 55.0 | 2 - 1.0 1 - 1.5 | \varnothing 20.012 TL 50.00 | | | | TEIKIN NO. |
| Surface Treatment Tin Coated Anodized Crown Bore Clearance MRC: 0.030 mm MP: 7.20 mm | TEIKIN NO. 46382 REFERENCE NO. 13101-37081 | | TEIKIN NO. P 46334 | | | | 41 |
| 2ZR-FE 4 cyl. | \varnothing 80.50 +2.5 CD 28.5 TL 50.1 | 2 - 1.0 1 - 1.5 | \varnothing 20.012 TL 50.00 | | | | TEIKIN NO. |
| Surface Treatment Anodized Crown Moly Skirt Bore Clearance MRC: 0.030 mm MP: 7.00 mm | TEIKIN NO. 46383 REFERENCE NO. 13101-37071 | | TEIKIN NO. P 46334 | | | | 42 |
| 3ZR-FE 4 cyl. | \varnothing 80.50 +2.20 CD 31.0 TL 51.2 | 2 - 1.0 1 - 1.5 | \varnothing 20.012 TL 50.00 | | | | TEIKIN NO. |
| Surface Treatment Anodized Crown Moly Skirt Bore Clearance MRC: 0.030 mm MP: 6.50 mm | TEIKIN NO. 46384 REFERENCE NO. 13101-37090 | | TEIKIN NO. P 46334 | | | | 43 |
| 3ZR-FE-II 1986 cc 4 cyl. | \varnothing 80.50 -4.3 CD 33.2 TL 51.3 | 1 - 1.2 1 - 1.0 1 - 2.0 | \varnothing 20.000 TL 50.00 | | | | TEIKIN NO. |
| Surface Treatment Anodized Crown Moly Skirt Bore Clearance MRC: 0.030 mm MP: 5.00 mm | TEIKIN NO. 46688 REFERENCE NO. 13101-37130 | | TEIKIN NO. P 46688 | | | | 44 |

T







| ENGINE TYPE | PISTON | PISTON RING | PISTON PIN | PIN BUSHING | LINER | | LINER KIT SET |
|---|--|-------------------------------|------------------------------------|-------------|---------|-----------|---------------|
| | | | | | FLANGED | NO FLANGE | |
| 4 A-GEU 1587 cc 4 cyl. COROLLA GTS F.I., DOHC 16V 1990-91 | \emptyset 81.00 +1.5 CD 30.5 TL 66.0 | 1 - 1.2 1 - 1.5 1 - 2.8 | \emptyset 20.000 TL 62.00 | | | | TEIKIN NO. |
| ENGINE COMPONENTS | TEIKIN NO. 46286 | | TEIKIN NO. P 38129 | | | | |
| Surface Treatment Bore Clearance Tin Coated MRC: 0.030 mm MP: 19.00 mm | REFERENCE NO. 13101-16121 | | | | | | 49 |
| 4A 1587 cc 4 cyl. | \emptyset 81.00 -2.5 CD 30.5 TL 60.5 | 2 - 1.5 1 - 2.8 | \emptyset 18.000 TL 61.00 | | | | TEIKIN NO. |
| ENGINE COMPONENTS | TEIKIN NO. 46336 | | TEIKIN NO. P 43187 | | | | |
| Surface Treatment Bore Clearance Tin Coated MRC: 0.030 mm MP: 15.50 mm | REFERENCE NO. 13101-16050 | | | | | | 50 |
| 4AC/ 4AELU 1587 cc 4 cyl. AE80 | \emptyset 81.00 -3.8 CD 30.6 TL 60.6 | 2 - 1.5 1 - 2.8 | \emptyset 18.000 TL 61.00 | | | | TEIKIN NO. |
| ENGINE COMPONENTS | TEIKIN NO. 46269 | | TEIKIN NO. P 43187 | | | | |
| Surface Treatment Bore Clearance None MRC: 0.030 mm MP: 15.50 mm | REFERENCE NO. 13101-16010 | | | | | | 51 |
| 4AFE, 4AG 1587 cc 4 cyl. COROLLA F.I., DOHC 4 1993-95 | \emptyset 81.00 -2.3 CD 30.5 TL 55.8 | 1 - 1.2 1 - 1.5 1 - 3.0 | \emptyset 20.000 TL 56.58 | | | | TEIKIN NO. |
| ENGINE COMPONENTS | TEIKIN NO. 46262 | | TEIKIN NO. P 42165 | | | | |
| Surface Treatment Bore Clearance Tin Coated MRC: 0.020 mm MP: 11.00 mm | REFERENCE NO. 13101-16160 13101-16201 | | | | | | 52 |

| ENGINE TYPE | PISTON | PISTON RING | PISTON PIN | PIN BUSHING | LINER | | LINER KIT SET |
|---|--|-------------------------------|--------------------------------|-------------|---------|-----------|---------------|
| | | | | | FLANGED | NO FLANGE | |
| 4AFE-II, 4AG 1587 cc 4 cyl. COROLLA F.I., DOHC 4 1993-95 | \emptyset 81.00 -2.3 CD 30.5 TL 55.8 | 1 - 1.2 1 - 1.5 1 - 3.0 | \emptyset 20.000 TL 56.58 | | | | TEIKIN NO. |
| | TEIKIN NO. | | TEIKIN NO. | | | | |
| Surface Treatment Bore Clearance Tin Coated MRC: 0.020 mm MP: 11.00 mm | 46266 | | P 42165 | | | | |
| REFERENCE NO. 13101-16160M 13101-16201M | | | | | | | |
| 4AFE-III 1587 cc 4 cyl. | \emptyset 81.00 -2.8 CD 30.5 TL 61.0 | 2 - 1.5 1 - 3.0 | \emptyset 18.000 TL 61.00 | | | | TEIKIN NO. |
| | TEIKIN NO. | | TEIKIN NO. | | | | |
| Surface Treatment Bore Clearance Tin Coated MRC: 0.030 mm MP: 16.00 mm | 46271 | | P 43187 | | | | |
| REFERENCE NO. 13101-16090 13101-16110 | | | | | | | |
| 4AGE 1587 cc 4 cyl. | \emptyset 81.00 -1.1 CD 30.6 TL 64.6 | 2 - 1.5 1 - 2.8 | \emptyset 18.000 TL 61.00 | | | | TEIKIN NO. |
| | TEIKIN NO. | | TEIKIN NO. | | | | |
| Surface Treatment Bore Clearance Tin Coated MRC: 0.030 mm MP: 18.30 mm | 46618 (46318) | | P 43187 | | | | |
| REFERENCE NO. 13101-16020 | | | | | | | |
| 4AGE. 4AGELC 1587 cc 4 cyl. COROLLA 1988-91 DOHC 16 V | \emptyset 81.00 -1.0 CD 30.6 TL 64.7 | 2 - 1.5 1 - 2.8 | \emptyset 20.000 TL 61.00 | | | | TEIKIN NO. |
| | TEIKIN NO. | | TEIKIN NO. | | | | |
| Surface Treatment Bore Clearance None MRC: 0.030 mm MP: 18.00 mm | 46310 | | P 46310 | | | | |
| REFERENCE NO. 13101-16070 | | | | | | | |

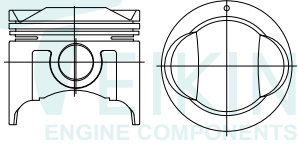
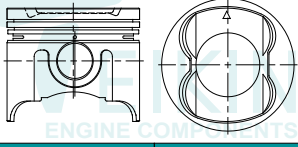
T

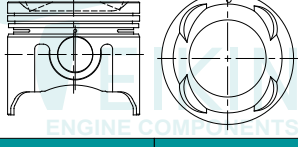
| ENGINE TYPE | PISTON | PISTON RING | PISTON PIN | PIN BUSHING | LINER | | LINER KIT SET |
|--|--|-------------------------------|------------------------------------|-------------|---------|-----------|---------------|
| | | | | | FLANGED | NO FLANGE | |
| 4AGEC, 4AGEU 1587 cc COROLLA GTS, FX 1985-87 4 cyl. | \emptyset 81.00 -2.8 CD 30.5 TL 61.0 | 2 - 1.5 1 - 2.8 | \emptyset 18.000 TL 61.00 | | | | TEIKIN NO. |
| | TEIKIN NO. | | TEIKIN NO. | | | | |
| Surface Treatment: Tin Coated Bore Clearance: MRC: 0.020 mm MP: 16.00 mm | | | | | | | |
| | REFERENCE NO. | | | | | | |
| | | | | | | | 57 |
| 4A-GEU - VVT 1587 cc 4 cyl. | \emptyset 81.00 +1.8 CD 30.4 TL 50.2 | 1 - 1.2 1 - 1.5 1 - 3.0 | \emptyset 20.000 TL 56.58 | | | | TEIKIN NO. |
| | TEIKIN NO. | | TEIKIN NO. | | | | |
| Surface Treatment: Tin Coated Bore Clearance: MRC: 0.030 mm MP: 5.50 mm | | | | | | | |
| | REFERENCE NO. | | | | | | |
| | | | | | | | 58 |
| 4A-GEU-II 1587 cc 4 cyl. | \emptyset 81.00 +0.5 CD 30.5 TL 65.0 | 2 - 1.5 1 - 2.8 | \emptyset 18.000 TL 61.00 | | | | TEIKIN NO. |
| | TEIKIN NO. | | TEIKIN NO. | | | | |
| Surface Treatment: None Bore Clearance: MRC: 0.030 mm MP: 18.30 mm | | | | | | | |
| | REFERENCE NO. | | | | | | |
| | | | | | | | 59 |
| 7 AFE 1762 cc COROLLA CELICA 1993-97 4 cyl. | \emptyset 81.00 -3.0 CD 30.4 TL 55.6 | 1 - 1.2 1 - 1.5 1 - 3.0 | \emptyset 20.000 TL 56.58 | | | | TEIKIN NO. |
| | TEIKIN NO. | | TEIKIN NO. | | | | |
| Surface Treatment: Tin Coated Bore Clearance: MRC: 0.020 mm MP: 11.00 mm | | | | | | | |
| | REFERENCE NO. | | | | | | |
| | | | | | | | 60 |

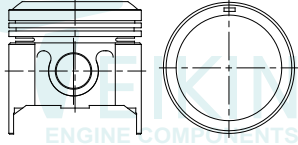
T

| ENGINE TYPE | PISTON | PISTON RING | PISTON PIN | PIN BUSHING | LINER | | LINER KIT SET |
|--|--|-------------------------------|--|-------------|---------|-----------|---------------|
| | | | | | FLANGED | NO FLANGE | |
| 5MGEU 2759 cc 6 cyl.  Surface Treatment Bore Clearance MRC: 0.030 mm MP: 16.00 mm | Ø 83.00 +1.7 CD 33.0 TL 72.5 | 2 - 1.5 1 - 4.0 | Ø 22.000 TL 66.00 | | | | TEIKIN NO. |
| | TEIKIN NO. 46632 | | TEIKIN NO. P 46632 | | | | |
| | REFERENCE NO. 13101-43041 | | | | | | |
| | | | | | | | 65 |
| 7MGE, 7MG 2954 cc 6 cyl. 1986-92 SUPRA 1989-92 CRESSIDA F.I., DOHC 6  Surface Treatment Bore Clearance Tin Coated MRC: 0.020 mm MP: 20.50 mm | Ø 83.00 -3.0 CD 33.0 TL 70.9 | 2 - 1.5 1 - 4.0 | Ø 22.000 TL 66.00  | | | | TEIKIN NO. |
| | TEIKIN NO. 46280 | | TEIKIN NO. P 39104 | | | | |
| | REFERENCE NO. 13101-42070 13101-42060 13101-42068 | | | | | | |
| | | | | | | | 66 |
| 7MGTE, 7MGTEU 2954 cc 6 cyl. SUPRA 24 V F.I., DOHC 6 1987-92  Surface Treatment Bore Clearance Anodized Crown MRC: 0.020 mm MP: 20.50 mm | Ø 83.00 -5.9 CD 33.0 TL 70.9 | 2 - 1.5 1 - 4.0 | Ø 22.000 TL 66.00  | | | | TEIKIN NO. |
| | TEIKIN NO. 46275 | | TEIKIN NO. P 39104 | | | | |
| | REFERENCE NO. 13101-42050 | | | | | | |
| | | | | | | | 67 |
| 21R, 2IRC 1972 cc 4 cyl.  Surface Treatment Bore Clearance None MRC: 0.030 mm MP: 20.50 mm | Ø 84.00 +5.0 CD 39.0 TL 84.0 | 1 - 1.5 1 - 2.0 1 - 4.0 | Ø 22.000 TL 72.00  | | | | TEIKIN NO. |
| | TEIKIN NO. 46199 | | TEIKIN NO. P 46199 | | | | |
| | REFERENCE NO. 13101-37050 13101-37030 | | | | | | |
| | | | | | | | 68 |

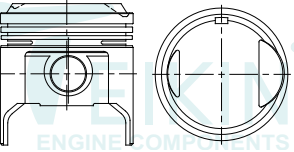
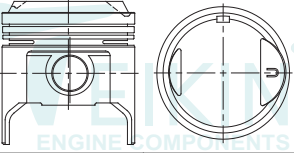
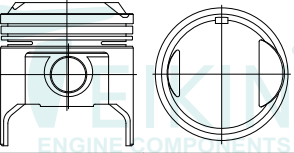
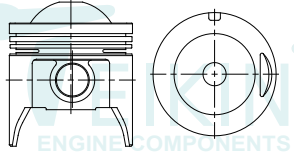
| ENGINE TYPE | PISTON | PISTON RING | PISTON PIN | PIN BUSHING | LINER | | LINER KIT SET |
|---|---|------------------------|--------------------------------|-------------|---------|-----------|---------------|
| | | | | | FLANGED | NO FLANGE | |
| 2T, 2T-B 1588 cc 4 cyl. CELICA LB, CARINA 1970-77 SPRINTER | \emptyset 85.00 +5.9 CD 39.1 TL 90.6 | 2 - 2.0 1 - 4.0 | \emptyset 22.000 TL 66.00 | | | | TEIKIN NO. |
|  | TEIKIN NO. 46207 | | TEIKIN NO. P 39104 | | | | |
| Surface Treatment Bore Clearance None MRC: 0.030 mm MP: 28.35 mm | REFERENCE NO. 13101-26010 13101-26011 | | | | | | 73 |
| 2T, 2T-U 1588 cc 4 cyl. CELICA, CARINA 1977 SPRINTER | \emptyset 85.00 +7.0 CD 39.0 TL 91.8 | 2 - 1.5 1 - 4.0 | \emptyset 22.000 TL 66.00 | | | | TEIKIN NO. |
|  | TEIKIN NO. 46211 | | TEIKIN NO. P 39104 | | | | |
| Surface Treatment Bore Clearance None MRC: 0.030 mm MP: 28.00 mm | REFERENCE NO. 13101-26031 | | | | | | 74 |
| 2T/2TB 1588 cc 4 cyl. | \emptyset 85.00 +7.0 CD 39.1 TL 91.8 | 2 - 2.0 1 - 4.0 | \emptyset 22.000 TL 66.00 | | | | TEIKIN NO. |
|  | TEIKIN NO. 46338 | | TEIKIN NO. P 39104 | | | | |
| Surface Treatment Bore Clearance None MRC: 0.030 mm MP: 28.00 mm | REFERENCE NO. 13101-26030 | | | | | | 75 |
| 2TC 1588 cc 4 cyl. | \emptyset 85.00 +14.5 CD 39.2 TL 99.4 | 2 - 2.0 1 - 4.0 | \emptyset 22.000 TL 66.00 | | | | TEIKIN NO. |
|  | TEIKIN NO. 46619 (46319) | | TEIKIN NO. P 39104 | | | | |
| Surface Treatment Bore Clearance Tin Coated MRC: 0.036 mm MP: 20.00 mm | REFERENCE NO. 13101-26020 13101-26021 | | | | | | 76 |

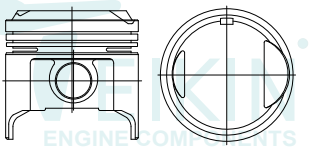
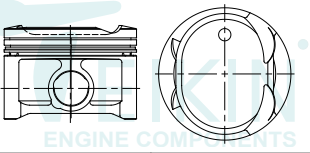
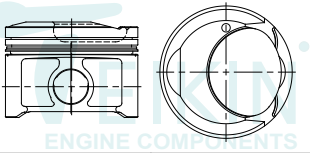
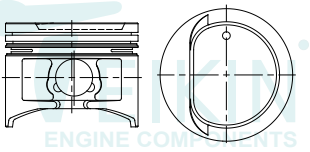
| ENGINE TYPE | PISTON | PISTON RING | PISTON PIN | PIN BUSHING | LINER | | LINER KIT SET |
|---|--|--------------------------------|--------------------------------|-------------|---------|-----------|---------------|
| | | | | | FLANGED | NO FLANGE | |
| 3T, 3T-U, 13T-U 1770 cc CELICA, CHASER 1977-80 CARINA 4 cyl. | \emptyset 85.00 +5.4 CD 35.0 TL 82.4 | 2 - 1.5 1 - 4.0 | \emptyset 22.000 TL 66.00 | | | | TEIKIN NO. |
|  | TEIKIN NO. 46218 | | TEIKIN NO. P 39104 | | | | |
| Surface Treatment None Bore Clearance MRC: 0.030 mm MP: 22.00 mm | REFERENCE NO. 13101-28010 | | | | | | 77 |
| 1AZFE 1998 cc 2.0L DOHC 16V RAV4 01-03 4 cyl. | \emptyset 86.00 +2.0 CD 38.9 TL 61.0 | 2 - 1.2 1 - 2.0 | \emptyset 22.000 TL 56.00 | | | | TEIKIN NO. |
|  | TEIKIN NO. 46353 | | TEIKIN NO. P 34101 | | | | |
| Surface Treatment Anodized Crown Moly Skirt Bore Clearance MRC: 0.030 mm MP: 6.50 mm | REFERENCE NO. 13101-28061 | | | | | | 78 |
| 1AZ-FSE 4 cyl. | \emptyset 86.00 +3.1 CD 38.9 TL 62.0 | 2 - 1.2 1 - 2.0 | \emptyset 22.000 TL 56.00 | | | | TEIKIN NO. |
|  | TEIKIN NO. 46365 | | TEIKIN NO. P 34101 | | | | |
| Surface Treatment Anodized Crown Moly Skirt Bore Clearance MRC: 0.030 mm MP: 5.50 mm | REFERENCE NO. 13211-28040-B0 | | | | | | 79 |
| 1RZ 1998 cc 4 cyl. | \emptyset 86.00 -4.2 CD 35.4 TL 67.4 | 1 - 1.75 1 - 1.5 1 - 4.0 | \emptyset 24.000 TL 61.00 | | | | TEIKIN NO. |
|  | TEIKIN NO. 46300 | | TEIKIN NO. P 46300 | | | | |
| Surface Treatment Tin Coated Bore Clearance MRC: 0.030 mm MP: 14.00 mm | REFERENCE NO. 13101-75010 | | | | | | 80 |

T

| ENGINE TYPE | PISTON | PISTON RING | PISTON PIN | PIN BUSHING | LINER | | LINER KIT SET |
|--|--|--------------------------------|---------------------------------|-------------|---------|-----------|---------------|
| | | | | | FLANGED | NO FLANGE | |
| 1RZ-III 4 cyl. Surface Treatment Tin Coated Bore Clearance MRC: 0.030 mm Anodized Crown MP: 7.00 mm | Ø 86.00 -4.8 CD 35.5 TL 59.0 | 1 - 1.75 1 - 1.5 1 - 4.0 | Ø 24.000 TL 61.00 | | | | TEIKIN NO. |
| | TEIKIN NO. 46359 | | TEIKIN NO. P 46300 | | | | |
| | REFERENCE NO. 13101-75090 13101-78700 | | | | | | |
| | | | | | | | 81 |
| 1TR-FE 1998 cc 4 cyl. Surface Treatment Anodized Crown Moly Skirt Bore Clearance MRC: 0.030 mm MP: 6.50 mm | Ø 86.00 +2.3 CD 32.7 TL 55.0 | 2 - 1.2 1 - 2.0 | Ø 22.000 TL 56.00 | | | | TEIKIN NO. |
| | TEIKIN NO. 46366 | | TEIKIN NO. P 34101 | | | | |
| | REFERENCE NO. 13101-0C010 13101-75120 | | | | | | |
| | | | | | | | 82 |
| 1Y 1587 cc 4 cyl. TOWN CAGE 1982 Surface Treatment Tin Coated Bore Clearance MRC: 0.030 mm MP: 21.00 mm | Ø 86.00 -1.8 CD 39.1 TL 74.0 | 2 - 1.5 1 - 4.0 | Ø 22.000 TL 66.00 | | | | TEIKIN NO. |
| | TEIKIN NO. 46118 | | TEIKIN NO. P 39104 | | | | |
| | REFERENCE NO. 13101-71010 | | | | | | |
| | | | | | | | 83 |
| 2Y 1812 cc 4 cyl. CORONA VAN 1982 Surface Treatment Tin Coated Bore Clearance MRC: 0.030 mm MP: 20.50 mm | Ø 86.00 -2.4 CD 35.1 TL 70.1 | 2 - 1.5 1 - 4.0 | Ø 22.000 TL 66.00 | | | | TEIKIN NO. |
| | TEIKIN NO. 46119 | | TEIKIN NO. P 39104 | | | | |
| | REFERENCE NO. 13101-72010 | | | | | | |
| | | | | | | | 84 |

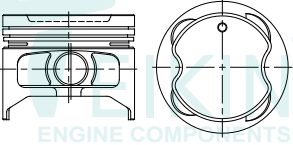
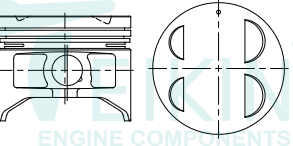
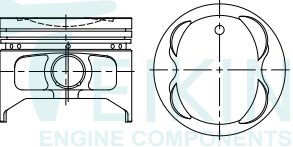
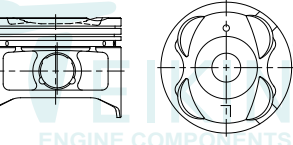
| ENGINE TYPE | PISTON | PISTON RING | PISTON PIN | PIN BUSHING | LINER | | LINER KIT SET |
|--|---|-------------------------------|--------------------------------|-------------|---------|-----------|---------------|
| | | | | | FLANGED | NO FLANGE | |
| 3SFE 1998 cc 4 cyl. CAMRY DOHC 4 1987-91 CELICA DOHC 4 1987-89 | \emptyset 86.00 -4.4 CD 35.4 TL 68.4 | 2 - 1.5 1 - 4.0 | \emptyset 20.000 TL 66.00 | | | | TEIKIN NO. |
|  | TEIKIN NO. 46255 | | TEIKIN NO. P 46187 | | | | |
| Surface Treatment Tin Coated Bore Clearance MRC: 0.020 mm MP: 18.00 mm | REFERENCE NO. 13101-74040 | | | | | | 85 |
| 3SFE-II 1998 cc 4 cyl. 3S-GELU 3S-GELC | \emptyset 86.00 -5.1 CD 35.1 TL 67.1 | 1 - 1.2 1 - 1.5 1 - 4.0 | \emptyset 22.000 TL 66.00 | | | | TEIKIN NO. |
|  | TEIKIN NO. 46620 (46320) | | TEIKIN NO. P 39104 | | | | |
| Surface Treatment Tin Coated Bore Clearance MRC: 0.030 mm MP: 17.00 mm | REFERENCE NO. 13101-74030 13101-74031 13101-74032 | | | | | | 86 |
| 3SFE-III 1998 cc 4 cyl. | \emptyset 86.00 -5.3 CD 35.0 TL 67.9 | 2 - 1.5 1 - 4.0 | \emptyset 22.000 TL 66.00 | | | | TEIKIN NO. |
|  | TEIKIN NO. 46621 (46324) | | TEIKIN NO. P 39104 | | | | |
| Surface Treatment Tin Coated Bore Clearance MRC: 0.030 mm MP: 18.00 mm | REFERENCE NO. 13101-74100 | | | | | | 87 |
| 3SFE-IV 1998 cc 4 cyl. | \emptyset 86.00 -4.3 CD 35.0 TL 65.5 | 2 - 1.5 1 - 4.0 | \emptyset 22.000 TL 66.00 | | | | TEIKIN NO. |
|  | TEIKIN NO. 46667 | | TEIKIN NO. P 39104 | | | | |
| Surface Treatment Tin Coated Bore Clearance MRC: 0.030 mm MP: 16.00 mm | REFERENCE NO. 13101-74170 | | | | | | 88 |





T

SUITABLE FOR



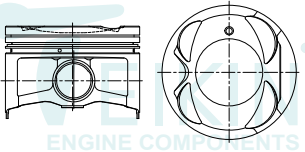
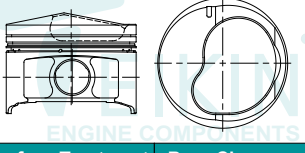
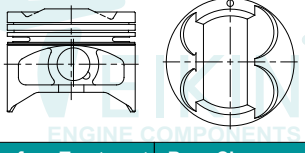

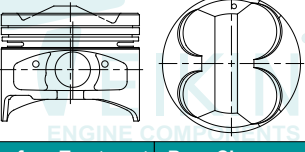
TOYOTA

GASOLINE



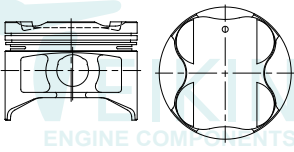
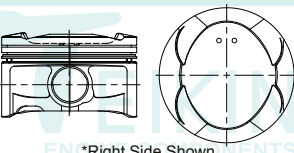

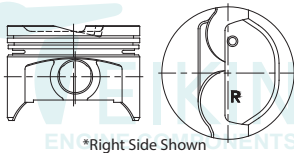
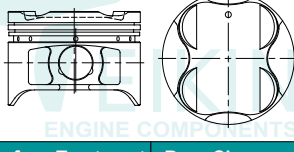



| ENGINE TYPE | PISTON | PISTON RING | PISTON PIN | PIN BUSHING | LINER | | LINER KIT SET |
|--|--|-------------------------------|--|-------------|---------|-----------|---------------|
| | | | | | FLANGED | NO FLANGE | |
| 3SFE-VII 4 cyl.  Surface Treatment Bore Clearance Tin Coated MRC: 0.030 mm MP: 10.50 mm | Ø 86.00 -4.2 CD 35.0 TL 59.2 | 2 - 1.2 1 - 3.0 | Ø 22.000 TL 56.00 | | | | TEIKIN NO. |
| | TEIKIN NO. 46373 | | TEIKIN NO. P 34101 | | | | |
| | REFERENCE NO. 13101-74191 | | | | | | |
| | | | | | | | 89 |
| 3S-FSE 1998 cc 4 cyl.  Surface Treatment Bore Clearance Moly Skirt MRC: 0.030 mm MP: 9.00 mm | Ø 86.00 +7.6 CD 35.0 TL 66.6 | 2 - 1.2 1 - 2.0 | Ø 22.000 TL 56.00 | | | | TEIKIN NO. |
| | TEIKIN NO. 46378 | | TEIKIN NO. P 34101 | | | | |
| | REFERENCE NO. 13101-74230-01 | | | | | | |
| | | | | | | | 90 |
| 3SGE 1998 cc 4 cyl.  Surface Treatment Bore Clearance Tin Coated MRC: 0.020 mm MP: 10.00 mm | Ø 86.00 +2.1 CD 35.1 TL 69.2 | 1 - 1.2 1 - 1.5 1 - 4.0 | Ø 22.000 TL 66.00  | | | | TEIKIN NO. |
| | TEIKIN NO. 46663 | | TEIKIN NO. P 39104 | | | | |
| | REFERENCE NO. 13101-88362 | | | | | | |
| | | | | | | | 91 |
| 3SGE-II 1998 cc 4 cyl. CARINA - CELICA MR2 ST182 - ST191, SW20 DOHC 16V (89-94)  Surface Treatment Bore Clearance Tin Coated MRC: 0.030 mm MP: 16.40 mm | Ø 86.00 +4.5 CD 35.1 TL 71.6 | 1 - 1.2 1 - 1.5 1 - 4.0 | Ø 22.000 TL 66.00  | | | | TEIKIN NO. |
| | TEIKIN NO. 46689 | | TEIKIN NO. P 39104 | | | | |
| | REFERENCE NO. 13101-88363 13103-88363 | | | | | | |
| | | | | | | | 92 |



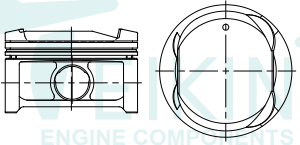

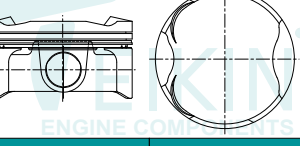

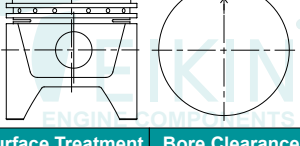
| ENGINE TYPE | PISTON | PISTON RING | PISTON PIN | PIN BUSHING | LINER | | LINER KIT SET |
|---|--|--------------------|------------------------------------|-------------|---------|-----------|---------------|
| | | | | | FLANGED | NO FLANGE | |
| 2JZGTE 2997 cc 6 cyl. F.I., DOHC, 24 V SUPRA TURBO 1993-98 | \emptyset 86.00 -3.8 CD 34.0 TL 65.0 | 2 - 1.5 1 - 4.0 | \emptyset 22.000 TL 66.00 | | | | TEIKIN NO. |
| ENGINE COMPONENTS Surface Treatment Bore Clearance Anodized Crown Moly Skirt MRC: 0.030 mm MP: 12.30 mm | TEIKIN NO. 46331G REFERENCE NO. 13101-46090 13101-46091 | | TEIKIN NO. P 39104 | | | | |
| | | | | | | | |
| | | | | | | 97 | |
| 5SFE 2164 cc 4 cyl. CELICIA, MR2 F.I., DOHC 4 1990-91 | \emptyset 87.00 -4.9 CD 32.5 TL 62.9 | 2 - 1.5 1 - 4.0 | \emptyset 22.000 TL 66.00 | | | | TEIKIN NO. |
| ENGINE COMPONENTS Surface Treatment Bore Clearance Tin Coated MRC: 0.020 mm MP: 15.00 mm | TEIKIN NO. 46279 REFERENCE NO. 13101-74130 13101-74080 | | TEIKIN NO. P 39104 | | | | |
| | | | | | | | |
| | | | | | | 98 | |
| 5SFE-II 2164 cc 4 cyl. 1998-99 CAMRY SOLARA | \emptyset 87.00 -4.3 CD 32.5 TL 56.5 | 2 - 1.2 1 - 3.0 | \emptyset 22.000 TL 66.00 | | | | TEIKIN NO. |
| ENGINE COMPONENTS Surface Treatment Bore Clearance None MRC: 0.030 mm MP: 7.00 mm | TEIKIN NO. 46309 REFERENCE NO. 13101-03060 | | TEIKIN NO. P 39104 | | | | |
| | | | | | | | |
| | | | | | | 99 | |
| 1MZFE 2995 cc 6 cyl. CAMRY SOLARA, AVALON, SIENNA F.I., DOHC 24V 1994-2002 | \emptyset 87.50 -2.5 CD 31.3 TL 51.3 | 2 - 1.2 1 - 3.0 | \emptyset 22.000 TL 55.00 | | | | TEIKIN NO. |
| ENGINE COMPONENTS *Right Side Shown Surface Treatment Bore Clearance Anodized Crown Moly Skirt MRC: 0.020 mm MP: 5.70 mm | TEIKIN NO. 46288 REFERENCE NO. 13101-20030 (R) 13101-20020 (L) 13101-20010 (R) 13301-20010 (L) | | TEIKIN NO. P 48102 | | | | |
| | | | | | | | |
| | | | | | | 100 | |

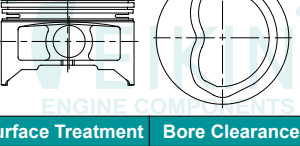
| ENGINE TYPE | PISTON | PISTON RING | PISTON PIN | PIN BUSHING | LINER | | LINER KIT SET |
|--|--|------------------------|---|-------------|---------|-----------|---------------|
| | | | | | FLANGED | NO FLANGE | |
| 2VZ-FE 2507 cc 6 cyl.  Surface Treatment Tin Coated Anodized Crown Bore Clearance MRC: 0.025 mm MP: 17.00 mm | \emptyset 87.50 -2.1 CD 32.2 TL 65.0 | 2 - 1.5 1 - 3.0 | \emptyset 21.004 TL 62.50 | | | | TEIKIN NO. |
| | TEIKIN NO. 46660 | | TEIKIN NO. P 46660 | | | | |
| | REFERENCE NO. 13101-62020 | | | | | | 101 |
| 3GR-FE 3000 cc V6 6 cyl.  *Right Side Shown Surface Treatment Anodized Crown Moly Skirt Bore Clearance MRC: 0.030 mm MP: 7.00 mm | \emptyset 87.50 +2.4 CD 31.2 TL 54.6 | 2 - 1.2 1 - 2.0 | \emptyset 22.000 TL 56.00  | | | | TEIKIN NO. |
| | TEIKIN NO. 46386 | | TEIKIN NO. P 34101 | | | | |
| | REFERENCE NO. 13301-31050 (R) 13101-31080 (L) | | | | | | 102 |
| 3VZE 2958 cc 6 cyl.  *Right Side Shown Surface Treatment None Bore Clearance MRC: 0.030 mm MP: 16.00 mm | \emptyset 87.50 -3.8 CD 33.7 TL 62.6 | 2 - 1.5 1 - 4.0 | \emptyset 21.000 TL 63.50 | | | | TEIKIN NO. |
| | TEIKIN NO. 46606 (46321) | | TEIKIN NO. P 32120 | | | | |
| | REFERENCE NO. 13101-65040 (R) 13301-65040 (L) | | | | | | 103 |
| 3VZ-FE 2958 cc CAMRY F.I., DOHC 6 1992-93 6 cyl.  Surface Treatment Tin Coated Bore Clearance MRC: 0.020 mm MP: 12.00 mm | \emptyset 87.50 -3.9 CD 34.0 TL 62.2 | 2 - 1.5 1 - 4.0 | \emptyset 22.000 TL 62.00  | | | | TEIKIN NO. |
| | TEIKIN NO. 46281 | | TEIKIN NO. P 43222 | | | | |
| | REFERENCE NO. 13101-62040 | | | | | | 104 |

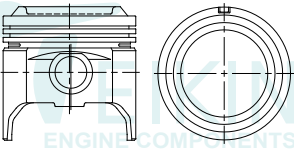
T

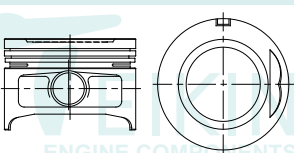

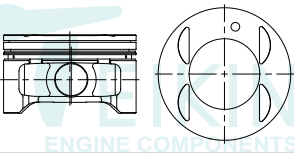

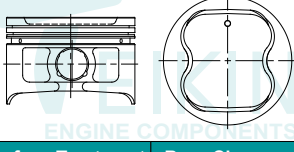

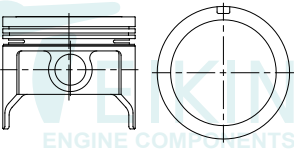

| ENGINE TYPE | PISTON | PISTON RING | PISTON PIN | PIN BUSHING | LINER | | LINER KIT SET |
|---|---|-------------------------------|------------------------------------|-------------|---------|-----------|---------------|
| | | | | | FLANGED | NO FLANGE | |
| 1UZFE 3968 cc 8 cyl. | \emptyset 87.50 -0.5 CD 34.0 TL 65.0 | 2 - 1.5 1 - 3.0 | \emptyset 22.000 TL 62.00 | | | | TEIKIN NO. |
| <p>*Right Side Shown</p> | TEIKIN NO. 46665 | | TEIKIN NO. P 43222 | | | | |
| Surface Treatment Tin Coated Bore Clearance MRC: 0.030 mm MP: 16.00 mm | REFERENCE NO. 13101-50020 (R) 13101-50010 (L) | | | | | | 105 |
| 1UZFE-II 8 cyl. | \emptyset 87.50 +2.3 CD 34.5 TL 55.8 | 2 - 1.2 1 - 3.0 | \emptyset 22.000 TL 62.00 | | | | TEIKIN NO. |
| <p>*Right Side Shown</p> | TEIKIN NO. 46350 | | TEIKIN NO. P 43222 | | | | |
| Surface Treatment Anodized Crown Moly Skirt Bore Clearance MRC: 0.030 mm MP: 5.00 mm | REFERENCE NO. 13101-50040-02 (R) 13301-50030-02 (L) | | | | | | 106 |
| 5R NEW 1994 cc 4 cyl. | \emptyset 88.00 +0.3 CD 38.8 TL 85.0 | 1 - 2.0 1 - 2.5 1 - 4.0 | \emptyset 22.000 TL 75.00 | | | | TEIKIN NO. |
| | TEIKIN NO. 46177 | | TEIKIN NO. P 46189 | | | | |
| Surface Treatment Tin Coated Bore Clearance MRC: 0.030 mm MP: 22.00 mm | REFERENCE NO. 13101-44016 | | | | | | 107 |
| 5R OLD 1979 1994 cc 4 cyl. | \emptyset 88.00 CD 39.0 TL 85.0 | 1 - 2.0 1 - 2.5 1 - 4.0 | \emptyset 22.000 TL 75.00 | | | | TEIKIN NO. |
| | TEIKIN NO. 46175 | | TEIKIN NO. P 46189 | | | | |
| Surface Treatment Tin Coated Bore Clearance MRC: 0.030 mm MP: 27.50 mm | REFERENCE NO. 13101-44015 13101-44011/12 13101-44013/14 | | | | | | 108 |

| ENGINE TYPE | PISTON | PISTON RING | PISTON PIN | PIN BUSHING | LINER | | LINER KIT SET |
|--|--|------------------------|---|-------------|---------|-----------|---------------|
| | | | | | FLANGED | NO FLANGE | |
| 2AZFE-II 2008-2011 4 cyl. | \varnothing 88.50 +2.1 CD 33.7 TL 55.8 | 2 - 1.0 1 - 2.0 | \varnothing 22.000 TL 56.00  | | | | TEIKIN NO. |
|  | TEIKIN NO. 46379 | TEIKIN NO. P 34101 | | | | | |
| Surface Treatment Bore Clearance Moly Skirt MRC: 0.030 mm Anodized Crown MP: 6.00 mm | REFERENCE NO. 13211-28110 | | | | | | |
| | | | | | | | |
| 1AR-FE 2672 cc DOHC 16V 4 cyl. | \varnothing 90.00 +3.1 CD 31.4 TL 53.0 | 2 - 1.0 1 - 2.0 | \varnothing 22.000 TL 56.00  | | | | TEIKIN NO. |
|  | TEIKIN NO. 46697 | TEIKIN NO. P 34101 | | | | | |
| Surface Treatment Bore Clearance Anodized Crown MRC: 0.030 mm Moly Skirt MP: 10.00 mm | REFERENCE NO. | | | | | | |
| | | | | | | | |
| F, FA-90 3878 cc LAND CRUISER 1954 6 cyl. | \varnothing 90.00 CD 47.6 TL 95.5 | 2 - 3.0 2 - 4.0 | \varnothing 25.150 TL 80.00  | | | | TEIKIN NO. |
|  | TEIKIN NO. 46132 | TEIKIN NO. P 46132 | | | | | |
| Surface Treatment Bore Clearance Tin Coated MRC: 0.050 mm MP: 27.50 mm | REFERENCE NO. 13101-60010 13101-60011 | | | | | | |
| | | | | | | | |
| 4Y 2237 cc VAN F.I., OHV 8V 1986-89 4 cyl. | \varnothing 91.00 -6.2 CD 35.0 TL 65.0 | 2 - 1.5 1 - 4.0 | \varnothing 22.000 TL 66.00  | | | | TEIKIN NO. |
|  | TEIKIN NO. 46122 | TEIKIN NO. P 39104 | | | | | |
| Surface Treatment Bore Clearance Tin Coated MRC: 0.030 mm MP: 15.50 mm | REFERENCE NO. 13101-73030 13101-73031 13101-73032 13103-73030/31 | | | | | | |
| | | | | | | | |

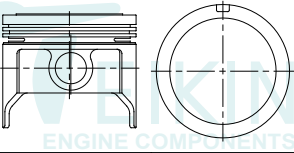
| ENGINE TYPE | PISTON | PISTON RING | PISTON PIN | PIN BUSHING | LINER | | LINER KIT SET |
|--|--|-------------------------------|---|-------------|---------|-----------|---------------|
| | | | | | FLANGED | NO FLANGE | |
| 22R 2366 cc 1981 4 cyl. | \emptyset 92.00 +6.4 CD 39.1 TL 92.5 | 1 - 2.0 1 - 2.5 1 - 4.0 | \emptyset 22.000 TL 75.00  | | | | TEIKIN NO. |
|  | TEIKIN NO. | | TEIKIN NO. | | | | |
| Surface Treatment None Bore Clearance MRC: 0.030 mm MP: 29.00 mm | REFERENCE NO. 13101-35010 13101-35020 | | P 46189 | | | | |
| | | | | | | 117 | |
| 22R-E 2366 cc 4 cyl. | \emptyset 92.00 -2.5 CD 35.0 TL 63.9 | 2 - 1.5 1 - 4.0 | \emptyset 22.000 TL 69.50  | | | | TEIKIN NO. |
|  | TEIKIN NO. | | TEIKIN NO. | | | | |
| Surface Treatment Tin Coated Bore Clearance MRC: 0.030 mm MP: 13.50 mm | REFERENCE NO. 13101-35032 13101-35030 13101-35031 | | P 46202 | | | | |
| | | | | | | 118 | |
| 3MZFE 3311 cc 6 cyl. 3.3L DOHC 24V CAMRY.HIGHLANDER 04-05 SIENNA.SOLARA 04-05 | \emptyset 92.00 -0.6 CD 31.2 TL 54.5 | 2 - 1.2 1 - 3.0 | \emptyset 22.000 TL 56.00  | | | | TEIKIN NO. |
|  | TEIKIN NO. | | TEIKIN NO. | | | | |
| Surface Treatment Anodized Crown Moly skirt Bore Clearance MRC: 0.030 mm MP: 9.40 mm | REFERENCE NO. 13101-0A040 13101-20050 | | P 34101 | | | | |
| | | | | | | 119 | |
| 5VZ-FE 3378 cc 6 cyl. | \emptyset 93.50 -4.9 CD 34.0 TL 63.0 | 2 - 1.5 1 - 4.0 | \emptyset 22.000 TL 62.00  | | | | TEIKIN NO. |
|  | TEIKIN NO. | | TEIKIN NO. | | | | |
| Surface Treatment Tin Coated Anodized Crown Bore Clearance MRC: 0.030 mm MP: 12.80 mm | REFERENCE NO. 13101-62060 | | P 43222 | | | | |
| | | | | | | 120 | |

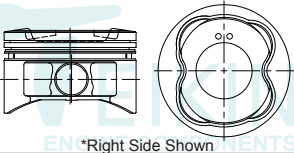
T

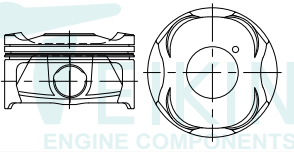
| ENGINE TYPE | PISTON | PISTON RING | PISTON PIN | PIN BUSHING | LINER | | LINER KIT SET |
|--|--|-------------------------------|------------------------------------|-------------|---------|-----------|---------------|
| | | | | | FLANGED | NO FLANGE | |
| 1GR-FE 4000 cc V6 6 cyl. | \emptyset 94.00 +2.8 CD 32.7 TL 56.5 | 2 - 1.2 1 - 2.0 | \emptyset 22.000 TL 62.00 | | | | TEIKIN NO. |
| | TEIKIN NO. 46368 | | TEIKIN NO. P 43222 | | | | |
| Surface Treatment Bore Clearance Anodized Crown Moly Skirt MRC: 0.030 mm MP: 8.00 mm | REFERENCE NO. 13101-31030 | | | | | | |
| | | | | | | 121 | |
| 2F 4230 cc LAND CRUISER 1975 6 cyl. | \emptyset 94.00 +0.4 CD 47.4 TL 95.8 | 1 - 2.0 1 - 2.5 1 - 4.0 | \emptyset 25.150 TL 71.80 | | | | TEIKIN NO. |
| | TEIKIN NO. 46136 | | TEIKIN NO. P 46136 | | | | |
| Surface Treatment Bore Clearance Tin Coated MRC: 0.030 mm MP: 26.30 mm | REFERENCE NO. 13101-61010 13101-61011 | | | | | | |
| | | | | | | 122 | |
| 2F-II 4230 cc 6 cyl. | \emptyset 94.00 +6.8 CD 47.5 TL 102.3 | 1 - 2.0 1 - 2.5 1 - 4.0 | \emptyset 25.150 TL 72.00 | | | | TEIKIN NO. |
| | TEIKIN NO. 46623 (46326) | | TEIKIN NO. P 46623 | | | | |
| Surface Treatment Bore Clearance Tin Coated MRC: 0.030 mm MP: 26.50 mm | REFERENCE NO. 13101-61020 | | | | | | |
| | | | | | | 123 | |
| 2GR-FE 3456 cc CAMRY V6 24 VALVE DOHC VVT-i 6 cyl. | \emptyset 94.00 +2.1 CD 31.3 TL 52.5 | 2 - 1.2 1 - 2.0 | \emptyset 22.000 TL 56.00 | | | | TEIKIN NO. |
| | TEIKIN NO. 46363 | | TEIKIN NO. P 34101 | | | | |
| Surface Treatment Bore Clearance Anodized Crown Moly Skirt MRC: 0.030 mm MP: 5.50 mm | REFERENCE NO. 13101-31091 13101-31090 13101-31092 | | | | | | |
| | | | | | | 124 | |

| ENGINE TYPE | PISTON | PISTON RING | PISTON PIN | PIN BUSHING | LINER | | LINER KIT SET |
|---|---|------------------------|---|-------------|---------|-----------|---------------|
| | | | | | FLANGED | NO FLANGE | |
| 3F 4230 cc 6 cyl.  Surface Treatment None Bore Clearance MRC: 0.030 mm MP: 27.50 mm | \emptyset 94.00 +0.3 CD 37.4 TL 79.7 | 2 - 1.5 1 - 4.0 | \emptyset 22.000 TL 75.00  | | | | TEIKIN NO. |
| | TEIKIN NO. 46138 | | TEIKIN NO. P 46189 | | | | |
| | REFERENCE NO. 13101-61030 13101-61031 | | | | | | 125 |
| 3F NEW, 3FE 3956 cc 6 cyl.  Surface Treatment None Bore Clearance MRC: 0.030 mm MP: 27.50 mm | \emptyset 94.00 +0.3 CD 37.4 TL 79.7 | 2 - 2.0 1 - 4.0 | \emptyset 22.000 TL 75.00  | | | | TEIKIN NO. |
| | TEIKIN NO. 46272 | | TEIKIN NO. P 46189 | | | | |
| | REFERENCE NO. 13101-61032 | | | | | | 126 |
| 2UZFE 4663 cc 8 cyl. LANDCRUISER SEQUOIA, TUNDRA 1998-2002 F.1., DOHC 32 V  <small>*Right Side Shown</small> Surface Treatment Anodized Crown Moly Skirt Bore Clearance MRC: 0.020 mm MP: 10.50 mm | \emptyset 94.00 +2.4 CD 33.9 TL 60.3 | 2 - 1.5 1 - 4.0 | \emptyset 22.000 TL 62.00  | | | | TEIKIN NO. |
| | TEIKIN NO. 46337 | | TEIKIN NO. P 43222 | | | | |
| | REFERENCE NO. 13101-50050-01(R) 13101-50040-01(L) | | | | | | 127 |
| 3UR-FE 5663 cc 8 cyl. V8  Surface Treatment Anodized Crown Moly Skirt 1st Ring Anodized Bore Clearance MRC: 0.030 mm MP: 6.50 mm | \emptyset 94.00 +1.8 CD 33.6 TL 55.3 | 2 - 1.2 1 - 2.0 | \emptyset 22.000 TL 56.00  | | | | TEIKIN NO. |
| | TEIKIN NO. 46388 | | TEIKIN NO. P 34101 | | | | |
| | REFERENCE NO. 13101-0S011 | | | | | | 128 |









T

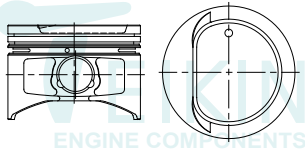

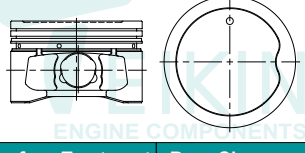

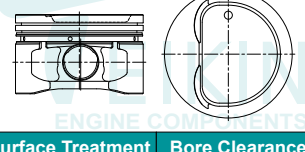

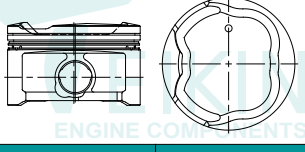
SUITABLE FOR

TOYOTA

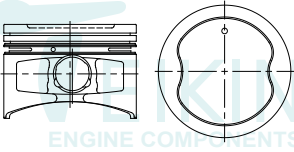
GASOLINE

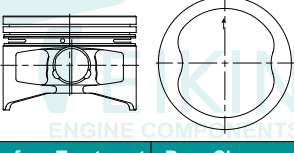

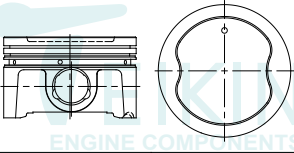

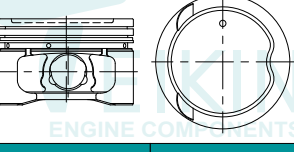



| ENGINE TYPE | PISTON | PISTON RING | PISTON PIN | PIN BUSHING | LINER | | LINER KIT SET |
|--|---|--------------------------------|---|-------------|---------|-----------|---------------|
| | | | | | FLANGED | NO FLANGE | |
| 2RZ, 2RZE 2438 cc 4 cyl.  Surface Treatment: Anodized Crown Bore Clearance: MRC: 0.030 mm, MP: 14.70 mm | Ø 95.00 -5.8 CD 35.5 TL 67.6 | 1 - 1.75 1 - 1.5 1 - 4.0 | Ø 24.007 TL 70.00  | | | | TEIKIN NO. |
| | TEIKIN NO. 46607 (46333) | | TEIKIN NO. P 46312 | | | | |
| | REFERENCE NO. 13101-75020 | | | | | | 129 |
| 2RZ-FE 2438 cc TACOMA 1995-99 4 cyl.  Surface Treatment: Anodized Crown, Moly Skirt Bore Clearance: MRC: 0.030 mm, MP: 7.60 mm | Ø 95.00 -0.9 CD 35.5 TL 58.9 | 2 - 1.5 1 - 4.0 | Ø 24.007 TL 70.00  | | | | TEIKIN NO. |
| | TEIKIN NO. 46311 | | TEIKIN NO. P 46312 | | | | |
| | REFERENCE NO. 13101-75070 13101-75071 | | | | | | 130 |
| 2RZ-FE-III 2438 cc 4 cyl.  Surface Treatment: Tin Coated, Anodized Crown Bore Clearance: MRC: 0.030 mm, MP: 7.50 mm | Ø 95.00 -5.7 CD 35.5 TL 59.0 | 1 - 1.75 1 - 1.5 1 - 4.0 | Ø 24.007 TL 70.00  | | | | TEIKIN NO. |
| | TEIKIN NO. 46375 | | TEIKIN NO. P 46312 | | | | |
| | REFERENCE NO. 13101-75080 | | | | | | 131 |
| 2TR-FE 2700 cc FORTUNER 2.7 4 cyl.  Surface Treatment: Anodized Crown, Moly Skirt Bore Clearance: MRC: 0.030 mm, MP: 6.30 mm | Ø 95.00 +2.2 CD 37.1 TL 59.4 | 2 - 1.2 1 - 2.0 | Ø 22.000 TL 62.00  | | | | TEIKIN NO. |
| | TEIKIN NO. 46360 | | TEIKIN NO. P 43222 | | | | |
| | REFERENCE NO. 13101-0C020 13101-75130 | | | | | | 132 |

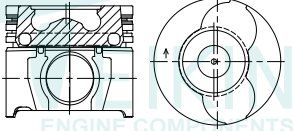

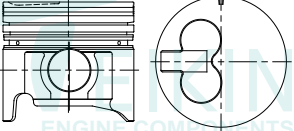

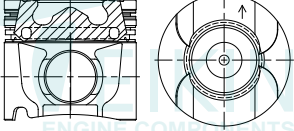

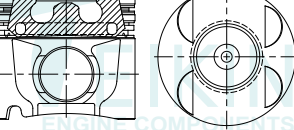

| ENGINE TYPE | PISTON | PISTON RING | PISTON PIN | PIN BUSHING | LINER | | LINER KIT SET |
|--|--|--------------------------------|---|-------------|---------|-----------|---------------|
| | | | | | FLANGED | NO FLANGE | |
| 2TZ-FE 2438 cc PREVIA 1990-95 DOHC 16 V 4 cyl. | \emptyset 95.00 -2.6 CD 35.5 TL 67.4 | 1 - 1.75 1 - 1.5 1 - 4.0 | \emptyset 24.007 TL 70.00  | | | | TEIKIN NO. |
|  | TEIKIN NO. | | TEIKIN NO. | | | | |
| Surface Treatment: Anodized Crown Bore Clearance: MRC: 0.030 mm MP: 14.60 mm | REFERENCE NO. | | | | | | |
| | | | | | | | 133 |
| 2TZ-FE-II 2438 cc PREVIA 1990-95 DOHC 16 V 4 cyl. | \emptyset 95.00 -6.4 CD 35.1 TL 67.0 | 1 - 1.75 1 - 1.5 1 - 4.0 | \emptyset 24.007 TL 70.00  | | | | TEIKIN NO. |
|  | TEIKIN NO. | | TEIKIN NO. | | | | |
| Surface Treatment: Anodized Crown Bore Clearance: MRC: 0.030 mm MP: 14.60 mm | REFERENCE NO. | | | | | | |
| | | | | | | | 134 |
| 2TZFZE 2438 cc F.I., DOHC, 16 V TURBO PREVIA 1995-98 4 cyl. | \emptyset 95.00 -3.3 CD 35.5 TL 58.0 | 1 - 1.75 1 - 1.5 1 - 4.0 | \emptyset 24.007 TL 70.00  | | | | TEIKIN NO. |
|  | TEIKIN NO. | | TEIKIN NO. | | | | |
| Surface Treatment: Anodized Crown Bore Clearance: MRC: 0.030 mm MP: 5.00 mm | REFERENCE NO. | | | | | | |
| | | | | | | | 135 |
| 3RZ-F 2693 cc COASTER RZB40-RZB50 (93-99) DOHC 16V 4 cyl. | \emptyset 95.00 -5.3 CD 37.6 TL 61.0 | 1 - 1.75 1 - 1.5 1 - 4.0 | \emptyset 24.000 TL 70.00  | | | | TEIKIN NO. |
|  | TEIKIN NO. | | TEIKIN NO. | | | | |
| Surface Treatment: Moly Skirt Anodized Crown 1st Ring Anodized Bore Clearance: MRC: 0.030 mm MP: 6.20 mm | REFERENCE NO. | | | | | | |
| | | | | | | | 136 |

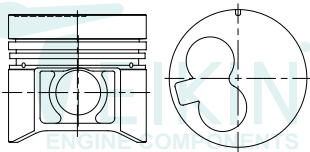
T

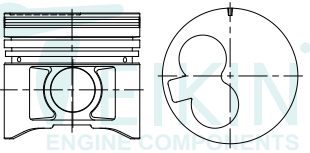
| ENGINE TYPE | PISTON | PISTON RING | PISTON PIN | PIN BUSHING | LINER | | LINER KIT SET |
|---|--|--------------------------------|--|-------------|---------|-----------|---------------|
| | | | | | FLANGED | NO FLANGE | |
| 3RZ-FE, 3RZ-FZ 2693 cc 4 cyl. 4 RUNNER 1996-99 T 100 1994-98 TACOMA 1995-99 DOHC 16 V | Ø 95.00 -2.8 CD 37.5 TL 61.0 | 2 - 1.5 1 - 4.0 | Ø 24.007 TL 70.00 | | | | TEIKIN NO. |
| | TEIKIN NO. 46312 | | TEIKIN NO. P 46312 | | | | |
| Surface Treatment Anodized Crown Moly Skirt | Bore Clearance MRC: 0.030 mm MP: 6.20 mm | | REFERENCE NO. 13101-75040 13101-75041 | | | | |
| | | | | | | | 137 |
| 1FZ-FE 4476 cc 6 cyl. | Ø 100.00 -3.9 CD 42.0 TL 76.0 | 2 - 2.0 1 - 4.0 | Ø 26.000 TL 62.70 | | | | TEIKIN NO. |
| | TEIKIN NO. 46270 | | TEIKIN NO. P 46270 | | | | |
| Surface Treatment Anodized Crown Moly skirt | Bore Clearance MRC: 0.040 mm MP: 14.50 mm | | REFERENCE NO. 13101-66020 | | | | |
| | | | | | | | 138 |
| 1FZ-FE-II 4476 cc 6 cyl. LAND CRUISER 1993-95, 96-97 DOHC, 24 V | Ø 100.00 -2.4 CD 42.0 TL 76.0 | 1 - 1.75 1 - 2.0 1 - 4.0 | Ø 26.000 TL 62.70 | | | | TEIKIN NO. |
| | TEIKIN NO. 46282 | | TEIKIN NO. P 46270 | | | | |
| Surface Treatment Anodized Crown Moly Skirt | Bore Clearance MRC: 0.040 mm MP: 14.50 mm | | REFERENCE NO. 13101-66040 | | | | |
| | | | | | | | 139 |
| 1FZ-FE-III 4477 cc 6 cyl. | Ø 100.00 -1.1 CD 42.0 TL 66.0 | 1 - 1.75 1 - 2.0 1 - 4.0 | Ø 26.000 TL 62.70 | | | | TEIKIN NO. |
| | TEIKIN NO. 46372 | | TEIKIN NO. P 46270 | | | | |
| Surface Treatment Anodized Crown Moly Skirt | Bore Clearance MRC: 0.030 mm MP: 6.00 mm | | REFERENCE NO. 13101-66050-02 | | | | |
| | | | | | | | 140 |

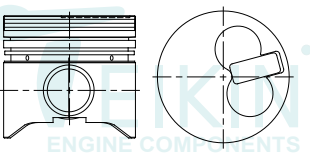

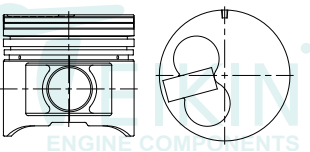

| ENGINE TYPE | PISTON | PISTON RING | PISTON PIN | PIN BUSHING | LINER | | LINER KIT SET |
|---|--|---|---|-------------------------------------|---|---------------|---|
| | | | | | FLANGED | NO FLANGE | |
| 1ND-TV 1364 cc 4 cyl. YARIS ECHO VERSO | \emptyset 73.00 -14.5 CD 41.7 TL 64.1 | 2 - 1.5 1 - 3.0 | \emptyset 27.000 TL 58.00  | | | | TEIKIN NO. LKSF 46676AG LKXS 46676AG |
|  | TEIKIN NO. 46676AG | TEIKIN NO. R 46676 | TEIKIN NO. P 46260 | TEIKIN NO. B 46676 | TEIKIN NO. LSF 46676 LSX 46676 | | |
| Surface Treatment Bore Clearance Tin Coated MRC: 0.030 mm Moly Skirt MP: 5.40 mm | REFERENCE NO. 13101-0W011 | REFERENCE NO. 13011-33041 13011-33060 13011-33070 | | REFERENCE NO. | REFERENCE NO. | | 141 |
| 1N 1453 cc 4 cyl. | \emptyset 74.00 -1.8 CD 38.5 TL 67.5 | 1 - 1.5 HK 1 - 1.5 1 - 3.0 | \emptyset 23.500 TL 58.00  | | TL 136.0 OD 78.0 FT 2.5 FD 82.0 | 133.0 78.0 | TEIKIN NO. LKSF 46276 LKXS 46276 LKSF 46276A LKXS 46276A |
|  | TEIKIN NO. 46276 46276A | TEIKIN NO. R 44276 | TEIKIN NO. P 46276 | TEIKIN NO. B 46276 | TEIKIN NO. LSF 46276 LSX 46276 | | |
| Surface Treatment Bore Clearance Tin Coated MRC: 0.030 mm MP: 15.00 mm | REFERENCE NO. 13101-55020 | REFERENCE NO. 12011-55010 12011-55011 12011-55010 | | REFERENCE NO. 90999-73109 | REFERENCE NO. | | 142 |
| 1CD-FTV 1995 cc 4 cyl. 1982 | \emptyset 82.20 -15.5 CD 47.8 TL 74.8 | 1 - 2.0 1 - 1.5 1 - 3.0 | \emptyset 31.000 TL 68.00  | | TL 151.0 OD 86.2 FT 5.0 FD 88.2 | 146.0 86.2 | TEIKIN NO. LKSF 46680AG LKXS 46680AG |
|  | TEIKIN NO. 46680AG | TEIKIN NO. R 46680 | TEIKIN NO. P 46680 | TEIKIN NO. B 46680 | TEIKIN NO. LSF 46680 LSX 46680 | | |
| Surface Treatment Bore Clearance Moly Skirt MRC: 0.060 mm MP: 6.50 mm | REFERENCE NO. 13101-OG010 13101-OG0A0 13101-OG0B0 13101-OG0C0 | REFERENCE NO. 13011-27030 13011-27040 | | REFERENCE NO. | REFERENCE NO. | | 143 |
| 1CD-FTV-II 1995 cc 4 cyl. AVENSIS PREVIA, RAV4 ACR30-CDT220-CLA2# 1999-2007 | \emptyset 82.20 -17.4 CD 47.8 TL 74.8 | 1 - 2.0 1 - 1.5 1 - 3.0 | \emptyset 31.000 TL 68.00  | | TL 151.0 OD 86.2 FT 5.0 FD 88.2 | 151.0 86.2 | TEIKIN NO. LKXS 46690AG LKSF 46690AG |
|  | TEIKIN NO. 46690AG | TEIKIN NO. R 46690 | TEIKIN NO. P 46680 | TEIKIN NO. B 46680 | TEIKIN NO. LSX 46680 LSF 46680 | | |
| Surface Treatment Bore Clearance Moly Skirt MRC: 0.080 mm MP: 7.00 mm | REFERENCE NO. 13101-27050 13101-27051 | REFERENCE NO. 13011-27030 13011-27040 | | REFERENCE NO. | REFERENCE NO. 21131-42001 | | 144 |







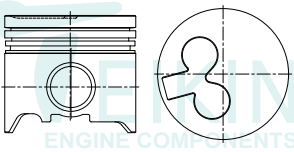

T

| ENGINE TYPE | PISTON | PISTON RING | PISTON PIN | PIN BUSHING | LINER | | | LINER KIT SET |
|--|--|--|---|-------------------------------------|--|---------------|--|---------------|
| | | | | | FLANGED | NO FLANGE | | |
| 1C 1839 cc 1982 4 cyl.  | \varnothing 83.00 -1.1 CD 47.0 TL 77.0 | 1 - 2.0 HK 1 - 2.0 1 - 4.0 | \varnothing 27.000 TL 68.00  | | TL 152.0 OD 86.0 FT 5.0 FD 88.0 | 150.0 87.0 | TEIKIN NO. LKSF 46112 LKSX 46112 LKFX 46112 LKSF 46112A LKSX 46112A LKFX 46112A | |
| | TEIKIN NO. 46112 46112A | TEIKIN NO. R 46112 | TEIKIN NO. P 39130 | TEIKIN NO. B 46112 | TEIKIN NO. LSF 46112 LSX 46112 LFX 46112 | | | |
| | REFERENCE NO. 13101-64010 13101-64020 | REFERENCE NO. 13011-64010/20/40 13011-64070/80 13013-64000/20/70 | REFERENCE NO. 90999-73091 90999-73101 | REFERENCE NO. 11461-64011 | | | | |
| | Surface Treatment Tin Coated Bore Clearance MRC: 0.030 mm MP: 11.50 mm | | | | | | | |
| 145 | | | | | | | | |
| 1C NEW 1839 cc 4 cyl.  | \varnothing 83.00 -1.3 CD 47.0 TL 76.9 | 1 - 2.0 HK 1 - 2.0 1 - 3.0 | \varnothing 27.000 TL 58.00  | | TL 152.0 OD 86.0 FT 5.0 FD 88.0 | 144.0 87.0 | TEIKIN NO. LKSX 46692 LKSF 46692 LKFX 46692 | |
| | TEIKIN NO. 46692 | TEIKIN NO. R 46630 | TEIKIN NO. P 46260 | TEIKIN NO. B 46260 | TEIKIN NO. LSX 46112 LSF 46112 LFX 46112 | | | |
| | REFERENCE NO. 13101-64130 | REFERENCE NO. 13011-6413 13011-64220 13013-64130 | REFERENCE NO. 90999-73101 90999-73102 90999-73138 | REFERENCE NO. 11461-64011 | | | | |
| | Surface Treatment Tin Coated Bore Clearance MRC: 0.030 mm MP: 11.50 mm | | | | | | | |
| 146 | | | | | | | | |
| 1C-II 1839 cc 4 cyl.  | \varnothing 83.00 -1.2 CD 47.0 TL 77.0 | 1 - 2.0 HK 1 - 2.0 1 - 3.0 | \varnothing 27.000 TL 58.00  | | TL 152.0 OD 86.0 FT 5.0 FD 88.0 | 150.0 87.0 | TEIKIN NO. LKSF 46650 LKSX 46650 LKFX 46650 | |
| | TEIKIN NO. 46650 | TEIKIN NO. R46630 | TEIKIN NO. P 46260 | TEIKIN NO. B 46260 | TEIKIN NO. LSF 46112 LSX 46112 LFX 46112 | | | |
| | REFERENCE NO. 13101-64060 | REFERENCE NO. 13011-64130 13011-64220 13011-64130 | REFERENCE NO. 90999-73101 90999-73102 90999-73138 | REFERENCE NO. 11461-64011 | | | | |
| | Surface Treatment Tin Coated Bore Clearance MRC: 0.040 mm MP: 15.00 mm | | | | | | | |
| 147 | | | | | | | | |
| 1C-III 1839 cc 4 cyl.  | \varnothing 83.00 -1.1 CD 47.0 TL 76.9 | 1 - 2.0 HK 1 - 2.0 1 - 3.0 | \varnothing 27.000 TL 58.00  | | TL 152.0 OD 86.0 FT 5.0 FD 88.0 | 150.0 87.0 | TEIKIN NO. LKSF 46630 LKSX 46630 LKFX 46630 | |
| | TEIKIN NO. 46630 | TEIKIN NO. R 46630 | TEIKIN NO. P 46260 | TEIKIN NO. B 46260 | TEIKIN NO. LSF 46112 LSX 46112 LFX 46112 | | | |
| | REFERENCE NO. 13101-64100 13101-64050 | REFERENCE NO. 13011-64130 13011-64220 13011-64130 | REFERENCE NO. 90999-73101 90999-73102 90999-73138 | REFERENCE NO. 11461-64011 | | | | |
| | Surface Treatment Tin Coated Bore Clearance MRC: 0.030 mm MP: 11.00 mm | | | | | | | |
| 148 | | | | | | | | |

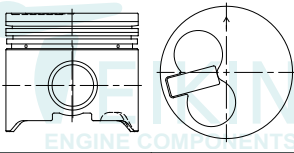

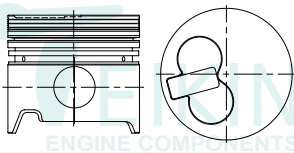

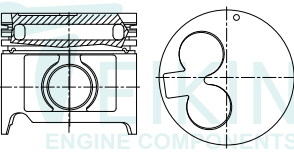



| ENGINE TYPE | PISTON | PISTON RING | PISTON PIN | PIN BUSHING | LINER | | LINER KIT SET |
|---|---|--|---|-------------------------------------|--|---------------|---|
| | | | | | FLANGED | NO FLANGE | |
| 1AD-FTV AVENSIS ADT250 | 1998 cc 4 cyl. Ø 86.00 -14.1 CD 48.0 TL 72.0 | 1 - 2.0 1 - 1.5 1 - 2.0 | Ø 29.000 TL 69.00 | | TL 160.0 OD 90.0 FT 3.0 FD 94.0 | 160.0 90.0 | TEIKIN NO. LKSF 46678AG LKSX 46678AG |
| | TEIKIN NO. 46678AG | TEIKIN NO. R 46678 | TEIKIN NO. P 46678 | TEIKIN NO. B 46678 | TEIKIN NO. LSF 46678 LSX 46678 | | 149 |
| Surface Treatment Moly Skirt | Bore Clearance MRC: 0.060 mm MP: 6.30 mm | REFERENCE NO. 13101-OR030 13101-OR032 | REFERENCE NO. 13011-26070 13011-OR010 13011-OR030 | REFERENCE NO. | REFERENCE NO. | | |
| 1DZ | 2486 cc 4 cyl. Ø 86.00 -2.3 CD 47.0 TL 77.0 | 1 - 2.0 HK 1 - 2.0 1 - 4.0 | Ø 27.000 TL 68.00 | | TL 180.0 OD 90.0 FT 5.0 FD 93.0 | 175.0 90.0 | |
| | TEIKIN NO. 46654A | TEIKIN NO. R 46654 | TEIKIN NO. P 39130 | TEIKIN NO. B 46654 | TEIKIN NO. LSF 46654 LSX 46654 | | 150 |
| Surface Treatment Tin Coated Anodized Crown | Bore Clearance MRC: 0.040 mm MP: 6.00 mm | REFERENCE NO. 13101-78201 | REFERENCE NO. 13011-78201 | REFERENCE NO. 90999-73950 | REFERENCE NO. 11461-78200 | | |
| 1DZ NEW | 2486 cc 4 cyl. Ø 86.00 -2.2 CD 46.4 TL 76.3 | 1 - 2.0 HK 1 - 2.0 1 - 3.0 | Ø 27.000 TL 68.00 | | TL 180.0 OD 90.0 FT 5.0 FD 93.0 | 175.0 90.0 | |
| | TEIKIN NO. 46684 | TEIKIN NO. R 46278 | TEIKIN NO. P 39130 | TEIKIN NO. B 46654 | TEIKIN NO. LSF 46654 LSX 46654 | | 151 |
| Surface Treatment Tin Coated Anodized Crown | Bore Clearance MRC: 0.040 mm MP: 11.00 mm | REFERENCE NO. 13101-78202 | REFERENCE NO. 13011-64190/1 13011-64202/10/12/13 13013-64190/1 13013-64212/3 | REFERENCE NO. 90999-73950 | REFERENCE NO. 11461-78200 11461-78020 | | |
| 2AD-FHV AVENSIS IS220D RAV4 ADT251-ALA30-ALF20 | 2231 cc 4 cyl. Ø 86.00 -14.5 CD 48.0 TL 72.0 | 1 - 2.0 1 - 1.5 1 - 2.0 | Ø 29.000 TL 69.00 | | TL 160.0 OD 90.0 FT 3.0 FD 94.0 | 160.0 90.0 | |
| | TEIKIN NO. 46679AG | TEIKIN NO. R 46678 | TEIKIN NO. P 46678 | TEIKIN NO. B 46678 | TEIKIN NO. LSF 46678 LSX 46678 | | 152 |
| Surface Treatment Moly Skirt | Bore Clearance MRC: 0.060 mm MP: 6.30 mm | REFERENCE NO. 13101-OR020/1/2 | REFERENCE NO. 13011-26070 13011-OR010 13011-OR030 | REFERENCE NO. | REFERENCE NO. | | |

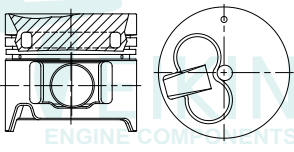

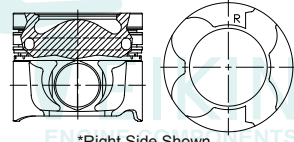

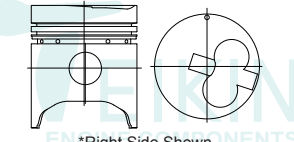

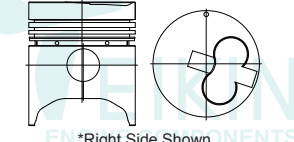

T

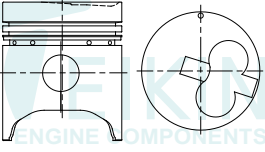
| ENGINE TYPE | PISTON | PISTON RING | PISTON PIN | PIN BUSHING | LINER | | LINER KIT SET |
|--|---|--|---|---|--|---------------|--|
| | | | | | FLANGED | NO FLANGE | |
| 2AD-FTV 2230 cc 4 cyl. AVENSIS - RAV4 (ADT251 - ALA30) 2005 | \emptyset 86.00 -13.9 CD 48.0 TL 72.0 | 1 - 2.0 1 - 1.5 1 - 2.0 | \emptyset 29.000 TL 69.00  | | TL 160.0 OD 90.0 FT 3.0 FD 94.0 | | TEIKIN NO. LKXSX 46696AG LKSF 46696AG |
| | TEIKIN NO. 46696AG | TEIKIN NO. R 46678 | TEIKIN NO. P 46678 | TEIKIN NO. B 46678 | TEIKIN NO. LSX 46678 LSF 46678 | | |
| | REFERENCE NO. 13101-0R010 13101-0R012 | REFERENCE NO. 13011-26070 13011-0R010 13011-0R030 | | REFERENCE NO. | REFERENCE NO. | | |
| | Surface Treatment Bore Clearance Moly Skirt MRC: 0.070 mm MP: 7.00 mm | | | | | | |
| | | | | | | | 153 |
| 2C 1974 cc 4 cyl. 1987-88 | \emptyset 86.00 -1.3 CD 47.0 TL 77.0 | 1 - 1.75 HK 1 - 2.0 1 - 3.0 | \emptyset 27.000 TL 58.00  | | TL 151.0 OD 89.2 FT 4.8 FD 91.0 | 150.0 90.0 | TEIKIN NO. LKSF 46260 LKXSX 46260 LKFX 46260 LKSF 46260A LKXSX 46260A LKFX 46260A |
| | TEIKIN NO. 46260 46260A | TEIKIN NO. R 46260 | TEIKIN NO. P 46260 | TEIKIN NO. B 46260 | TEIKIN NO. LSF 46260 LSX 46260 LFX 46260 | | |
| | REFERENCE NO. 13101-64090 | REFERENCE NO. 13011-64170 13013-64170 | | REFERENCE NO. 90999-73101 90999-73102 90999-73138 | REFERENCE NO. 11461-64090 | | |
| | Surface Treatment Bore Clearance Tin Coated MRC: 0.030 mm MP: 12.00 mm | | | | | | |
| | | | | | | | 154 |
| 2C-II, 2CT LATE 1974 cc 4 cyl. | \emptyset 86.00 -1.3 CD 47.0 TL 77.0 | 1 - 2.0 HK 1 - 2.0 1 - 3.0 | \emptyset 27.000 TL 58.00  | | TL 151.0 OD 89.2 FT 4.8 FD 91.0 | 150.0 90.0 | TEIKIN NO. LKSF 46264 LKXSX 46264 LKFX 46264 LKSF 46264A LKXSX 46264A LKFX 46264A |
| | TEIKIN NO. 46264 46264A | TEIKIN NO. R 46260 | TEIKIN NO. P 46260 | TEIKIN NO. B 46260 | TEIKIN NO. LSF 46260 LSX 46260 LFX 46260 | | |
| | REFERENCE NO. 13101-64120 13101-64121 | REFERENCE NO. 13011-64170 13013-64170 | | REFERENCE NO. 90999-73101 90999-73102 90999-73138 | REFERENCE NO. 11461-64090 | | |
| | Surface Treatment Bore Clearance Tin Coated MRC: 0.030 mm MP: 12.00 mm | | | | | | |
| | | | | | | | 155 |
| 2C-III 1974 cc 4 cyl. 1983-85 | \emptyset 86.00 -1.4 CD 47.0 TL 77.0 | 1 - 2.0 HK 1 - 2.0 1 - 4.0 | \emptyset 27.000 TL 68.00  | | TL 151.0 OD 89.2 FT 4.8 FD 91.0 | 150.0 90.0 | TEIKIN NO. LKSF 46601 LKXSX 46601 LKFX 46601 LKSF 46601A LKXSX 46601A LKFX 46601A |
| | TEIKIN NO. 46601 46601A (46284) | TEIKIN NO. R 46601 | TEIKIN NO. P 39130 | TEIKIN NO. B 46112 | TEIKIN NO. LSF 46260 LSX 46260 LFX 46260 | | |
| | REFERENCE NO. 13101-64030 | REFERENCE NO. 13011-64060 13011-64110/50 13013-64060 13013-64110/50 | | REFERENCE NO. 90999-73091 90999-73101 | REFERENCE NO. 11461-64090 | | |
| | Surface Treatment Bore Clearance Tin Coated MRC: 0.030 mm MP: 12.00 mm | | | | | | |
| | | | | | | | 156 |

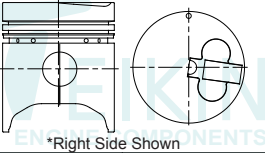

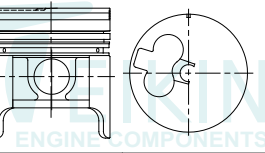

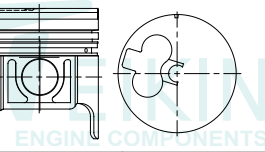

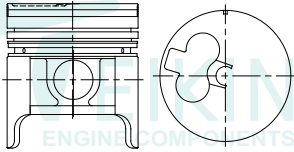

| ENGINE TYPE | PISTON | PISTON RING | PISTON PIN | PIN BUSHING | LINER | | LINER KIT SET | |
|--|--|----------------------------------|---|----------------------|--|-----------|--|--|
| | | | | | FLANGED | NO FLANGE | | |
| 2C-IV 4 cyl.  Surface Treatment Bore Clearance Tin Coated MRC: 0.030 mm Anodized Crown MP: 12.00 mm 1st Ring Anodized | \emptyset 86.00 -1.8 CD 47.0 TL 77.0 | 1 - 2.0 HK 1 - 2.0 1 - 3.0 | \emptyset 27.000 TL 58.00  | | | | TEIKIN NO. 46374 46374A REFERENCE NO. 13101-64190-02 157 | |
| | TEIKIN NO. | | TEIKIN NO. | | | | | |
| | 46374 46374A | | P 46260 | | | | | |
| | REFERENCE NO. | | | | | | | |
| 2C-T 1974 cc 4 cyl.  Surface Treatment Bore Clearance Tin Coated MRC: 0.030 mm MP: 12.00 mm | \emptyset 86.00 -1.3 CD 47.0 TL 77.0 | 1 - 2.0 HK 1 - 2.0 1 - 3.0 | \emptyset 27.000 TL 58.00  | | TL 151.0 OD 89.2 FT 4.8 FD 90.0 | | TEIKIN NO. LKSF 46278 LKSX 46278 LKFX 46278 LKSF 46278A LKSX 46278A LKFX 46278A 158 | |
| | TEIKIN NO. | TEIKIN NO. | TEIKIN NO. | TEIKIN NO. | TEIKIN NO. | | | |
| | 46278 46278A | R 46278 | P 46260 | B 46260 | LSF 46260 LSX 46260 LFX 46260 | | | |
| | REFERENCE NO. | REFERENCE NO. | REFERENCE NO. | REFERENCE NO. | REFERENCE NO. | | | |
| 2CT-II 1974 cc 4 cyl.  Surface Treatment Bore Clearance Tin Coated MRC: 0.030 mm MP: 14.00 mm | \emptyset 86.00 -1.3 CD 47.0 TL 77.0 | 1 - 2.0 HK 1 - 2.0 1 - 4.0 | \emptyset 27.000 TL 61.10  | | TL 151.0 OD 89.2 FT 4.8 FD 90.0 | | TEIKIN NO. LKSF 46609 LKSX 46609 LKFX 46609 LKSF 46609A LKSX 46609A LKFX 46609A 159 | |
| | TEIKIN NO. | TEIKIN NO. | TEIKIN NO. | TEIKIN NO. | TEIKIN NO. | | | |
| | 46609 46609A (46293) | R 46601 | P 46609 | B 46260 | LSF 46260 LSX 46260 LFX 46260 | | | |
| | REFERENCE NO. | REFERENCE NO. | REFERENCE NO. | REFERENCE NO. | REFERENCE NO. | | | |
| 2CT-III 1974 cc 4 cyl. AVENSIS (CT220) 1998-2000  Surface Treatment Bore Clearance Anodized Crown MRC: 0.030 mm Tin Coated MP: 10.00 mm | \emptyset 86.00 -1.4 CD 47.0 TL 77.0 | 1 - 2.0 HK 1 - 2.0 1 - 3.0 | \emptyset 27.000 TL 66.00  | | TL 151.0 OD 89.2 FT 4.8 FD 91.0 | | TEIKIN NO. LKSX 46695AG LKSF 46695AG LKFX 46695AG 160 | |
| | TEIKIN NO. | TEIKIN NO. | TEIKIN NO. | TEIKIN NO. | TEIKIN NO. | | | |
| | 46695AG | R 46278 | P 46695 | B 46260 | LSX 46260 LSF 46260 LFX 46260 | | | |
| | REFERENCE NO. | REFERENCE NO. | REFERENCE NO. | REFERENCE NO. | REFERENCE NO. | | | |

T

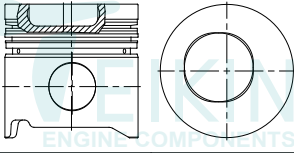
| ENGINE TYPE | PISTON | PISTON RING | PISTON PIN | PIN BUSHING | LINER | | LINER KIT SET |
|---|---|---|---|---|--|---------------|---|
| | | | | | FLANGED | NO FLANGE | |
| 3C 2184 cc 4 cyl.  *Right Side Shown | Ø 86.00 -3.2 CD 42.5 TL 72.5 | 1 - 2.0 HK 1 - 2.0 1 - 3.0 | Ø 27.000 TL 61.00  | | TL 151.0 OD 89.2 FT 4.8 FD 91.0 | 150.0 90.0 | TEIKIN NO. LKSF 46629A LKSX 46629A LKFX 46629A LKSF 46629G LKSX 46629G LKFX 46629G LKSF 46629AG LKSX 46629AG LKFX 46629AG REFERENCE NO. 13101-64150 13101-64151 13101-64210 13011-64190/1 13011-64202/10/12/13 13013-64190/1 13013-64212/3 90999-73101 90999-73102 90999-73138 REFERENCE NO. 11461-64090 |
| | TEIKIN NO. 46629A 46629G 46629AG (46328) | TEIKIN NO. R 46278 | TEIKIN NO. P 46629 | TEIKIN NO. B 46260 | TEIKIN NO. LSF 46260 LSX 46260 LFX 46260 | | |
| | REFERENCE NO. 13101-64150 13101-64151 13101-64210 | REFERENCE NO. 13011-64190/1 13011-64202/10/12/13 13013-64190/1 13013-64212/3 | REFERENCE NO. 90999-73101 90999-73102 90999-73138 | REFERENCE NO. 11461-64090 | | | |
| | Surface Treatment Bore Clearance Tin Coated MRC: 0.030 mm MP: 11.50 mm | | | | | | |
| 161 | | | | | | | |
| 1VD-FTV 4461 cc 8 cyl. LAND CRUISER  *Right Side Shown | Ø 86.00 -13.9 CD 48.0 TL 72.0 | 1 - 2.0 1 - 1.5 1 - 2.0 | Ø 29.000 TL 69.00  | | | | TEIKIN NO. |
| | TEIKIN NO. 46691AG | TEIKIN NO. R 46675 | TEIKIN NO. P 46678 | | | | |
| | REFERENCE NO. 13101-0W020 (L/R) 13301-0W010 (L/R) | REFERENCE NO. 13011-51031 13011-51040 | | | | | |
| | Surface Treatment Bore Clearance Moly Skirt MRC: 0.070 mm MP: 6.00 mm | | | | | | |
| 162 | | | | | | | |
| 2J 2481 cc 4 cyl. FORKLIFT SDKB 1975 H NEW, 6 Cyl.  *Right Side Shown | Ø 88.00 -3.0 CD 52.2 TL 102.2 | 1 - 2.5 HK 1 - 2.5 1 - 4.0 | Ø 27.000 TL 74.00  | | TL 183.5 OD 93.0 FT 2.5 +1.0 FD 98.0 | | LKFF 46226 LKSF 46226 LKFF 46226A LKSF 46226A |
| | TEIKIN NO. 46226 46226A | TEIKIN NO. R 46226 | TEIKIN NO. P 46240 | TEIKIN NO. B 46226 | TEIKIN NO. LFF 46226 LSF 46226 | | |
| | REFERENCE NO. 13101-48014/5 (R/L) 13081-48014/5 | REFERENCE NO. 13011-48022/3/30 13015-48022/3 | REFERENCE NO. 90999-70048 90999-73069 90999-73083 | REFERENCE NO. 11461-47011 11461-48010 11461-48011 | | | |
| | Surface Treatment Bore Clearance Tin Coated MRC: 0.100 mm MP: 29.40 mm | | | | | | |
| 163 | | | | | | | |
| 2J-III 4 cyl.  *Right Side Shown | Ø 88.00 -3.0 CD 52.2 TL 102.2 | 1 - 2.5 HK 2 - 2.5 1 - 4.0 | Ø 27.000 TL 74.00  | | | | TEIKIN NO. |
| | TEIKIN NO. 46369 | TEIKIN NO. R 46369 | TEIKIN NO. P 46240 | | | | |
| | REFERENCE NO. 13081-22060-71 | REFERENCE NO. 13011-48013 13011-48021 13015-48021 | | | | | |
| | Surface Treatment Bore Clearance Tin Coated MRC: 0.100 mm MP: 29.40 mm | | | | | | |
| 164 | | | | | | | |

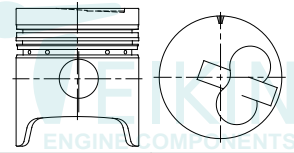

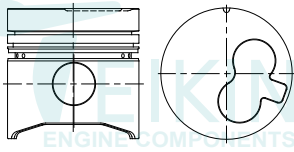



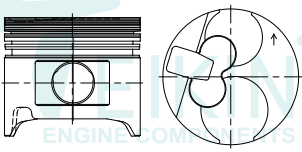

| ENGINE TYPE | PISTON | PISTON RING | PISTON PIN | PIN BUSHING | LINER | | LINER KIT SET |
|--|---|--|---|---|--|------------|---|
| | | | | | FLANGED | NO FLANGE | |
| H NEW 2481 cc 6 cyl.  Surface Treatment Bore Clearance Tin Coated MRC: 0.100 mm MP: 29.40 mm | \emptyset 88.00 -3.0 CD 52.2 TL 102.2 | 1 - 2.5 HK 1 - 2.5 1 - 4.0 | \emptyset 27.000 TL 74.00  | | TL 183.5 OD 93.0 FT 2.5 +1.0 FD 98.0 | | TEIKIN NO. LKFF 46226-6 LKSF 46226-6 LKFF 46226A-6 LKSF 46226A-6 |
| | TEIKIN NO. 46226-6 46226A-6 | TEIKIN NO. R 46226 | TEIKIN NO. P 46240 | TEIKIN NO. B 46226 | TEIKIN NO. LFF 46226 LSF 46226 | | |
| | REFERENCE NO. 13101-48014/5 (R/L) 13081-48014/5 | REFERENCE NO. 13011-48022/3/30 13015-48022/3 | REFERENCE NO. 90999-70048 90999-73069 90999-73083 | REFERENCE NO. 11461-47011 11461-48010 11461-48011 | | | |
| | | | | | | 165 | |
| H-II 3576 cc 6 cyl.  *Right Side Shown Surface Treatment Bore Clearance Tin Coated MRC: 0.100 mm MP: 29.20 mm | \emptyset 88.00 -3.0 CD 52.2 TL 102.2 | 1 - 2.5 HK 1 - 2.5 1 - 4.0 | \emptyset 27.000 TL 74.00  | | TL 183.5 OD 93.0 FT 2.5 +1.0 FD 98.0 | | TEIKIN NO. LKFF 46316 LKSF 46316 |
| | TEIKIN NO. 46316 (46617) | TEIKIN NO. R 46316 | TEIKIN NO. P 46240 | TEIKIN NO. B 46316 | TEIKIN NO. LFF 46316 LSF 46316 | | |
| | REFERENCE NO. 13081-47012(R/L) 13081-47013 13101-47012 13101-47013 | REFERENCE NO. 13011-47022/3 13015-47022/3 | REFERENCE NO. 90999-70048 90999-73069 90999-73083 | REFERENCE NO. 11461-47011 11461-48010 11461-48011 | | | |
| | | | | | | 166 | |
| L NEW, LN50 2188 cc 4 cyl.  Surface Treatment Bore Clearance Tin Coated MRC: 0.070 mm MP: 26.00 mm | \emptyset 90.00 -1.6 CD 52.2 TL 99.2 | 1 - 2.0 HK 1 - 2.0 1 - 4.0 | \emptyset 27.000 TL 74.00  | | TL 160.5 OD 94.0 FT 3.5 +1.2 FD 101.0 | | TEIKIN NO. LKFF 46236 LKSF 46236 |
| | TEIKIN NO. 46236 | TEIKIN NO. R 46236 | TEIKIN NO. P 46240 | TEIKIN NO. B 46226 | TEIKIN NO. LFF 46234 LSF 46234 | | |
| | REFERENCE NO. 13101-54040 13101-54031 | REFERENCE NO. 13011-54030/1 13011-54040/1/2 13011-54080 13013-54040/1 | REFERENCE NO. 90999-70048 90999-73069 90999-73083 | REFERENCE NO. 11461-54010 | | | |
| | | | | | | 167 | |
| L NEW-II 2188 cc CROWN DIESEL 1981 4 cyl.  Surface Treatment Bore Clearance Tin Coated MRC: 0.070 mm MP: 25.00 mm | \emptyset 90.00 -1.4 CD 52.2 TL 99.2 | 1 - 2.0 HK 1 - 2.0 1 - 4.0 | \emptyset 27.000 TL 74.00  | | TL 160.5 OD 94.0 FT 3.5 +1.2 FD 101.0 | | TEIKIN NO. LKFF 46238 LKSF 46238 |
| | TEIKIN NO. 46238 | TEIKIN NO. R 46236 | TEIKIN NO. P 46240 | TEIKIN NO. B 46226 | TEIKIN NO. LFF 46234 LSF 46234 | | |
| | REFERENCE NO. 13101-54020 13101-54021 | REFERENCE NO. 13011-54030/1 13011-54040/1/2 13011-54080 13013-54040/1 | REFERENCE NO. 90999-70048 90999-73069 90999-73083 | REFERENCE NO. 11461-54010 | | | |
| | | | | | | 168 | |

T

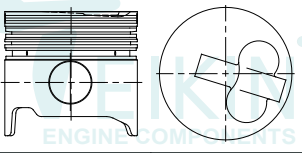
| ENGINE TYPE | PISTON | PISTON RING | PISTON PIN | PIN BUSHING | LINER | | LINER KIT SET |
|--|---|--|---|-------------------------------------|--|-----------|---|
| | | | | | FLANGED | NO FLANGE | |
| L OLD, LN30 2188 cc 4 cyl. HI-ACE, HILUX 1977  | \varnothing 90.00 -1.6 CD 52.2 TL 99.2 | 1 - 2.5 1 - 2.0 1 - 4.0 | \varnothing 27.000 TL 74.00  | | TL 160.5 OD 94.0 FT 3.5 +1.2 FD 101.0 | | TEIKIN NO. LKFF 46234 LKSF 46234 |
| | TEIKIN NO. 46234 | TEIKIN NO. R 46234 | TEIKIN NO. P 46240 | TEIKIN NO. B 46226 | TEIKIN NO. LFF 46234 LSF 46234 | | |
| | REFERENCE NO. 13101-54010 13101-54012 | REFERENCE NO. 13011-54010 13011-54020 13011-54021 13013-54020 | REFERENCE NO. 90999-70048 90999-73069 90999-73083 | REFERENCE NO. 11461-54010 | | | |
| | Surface Treatment Bore Clearance Tin Coated MRC: 0.070 mm MP: 26.00 mm | | | | | | |
| 12H-T 3980 cc 6 cyl.  | \varnothing 91.00 -15.2 CD 56.3 TL 91.3 | 1 - 2.5 HK 1 - 2.5 1 - 4.0 | \varnothing 32.000 TL 76.00  | | TL 183.5 OD 95.0 FT 2.5 +1.0 FD 101.0 | | TEIKIN NO. LKFF 46624 LKSF 46624 LKFF 46624A LKSF 46624A |
| | TEIKIN NO. 46624 46624A (46291) | TEIKIN NO. R 46624 | TEIKIN NO. P 46613 | TEIKIN NO. B 46624 | TEIKIN NO. LFF 46231 LSF 46231 | | |
| | REFERENCE NO. 13101-68020 | REFERENCE NO. 13011-68030 13013-68030 | REFERENCE NO. 90999-73108 | REFERENCE NO. 11461-68010 | | | |
| | Surface Treatment Bore Clearance Tin Coated MRC: 0.030 mm MP: 14.00 mm | | | | | | |
| 2H 3980 cc 6 cyl. 1982  | \varnothing 91.00 -3.0 CD 52.2 TL 102.2 | 1 - 2.5 HK 1 - 2.5 1 - 4.0 | \varnothing 29.000 TL 75.00  | | TL 183.5 OD 95.0 FT 2.5 +1.0 FD 101.0 | | TEIKIN NO. LKFF 46231 LKSF 46231 LKFF 46231A LKSF 46231A |
| | TEIKIN NO. 46231 46231A | TEIKIN NO. R 46231 | TEIKIN NO. P 43171 | TEIKIN NO. B 46231 | TEIKIN NO. LFF 46231 LSF 46231 | | |
| | REFERENCE NO. 13101-68010 13081-68010 | REFERENCE NO. 13011-68010 13011-68020 13011-96601 13013-68020 | REFERENCE NO. 90999-73087 | REFERENCE NO. 11461-68010 | | | |
| | Surface Treatment Bore Clearance Tin Coated MRC: 0.050 mm MP: 28.75 mm | | | | | | |
| 2H LATE 3980 cc 6 cyl.  | \varnothing 91.00 -1.6 CD 52.2 TL 90.1 | 1 - 2.5 HK 1 - 2.5 1 - 4.0 | \varnothing 29.000 TL 74.00  | | TL 183.5 OD 95.0 FT 2.5 +1.0 FD 101.0 | | TEIKIN NO. LKFF 46611 LKSF 46611 |
| | TEIKIN NO. 46611 (46302) | TEIKIN NO. R 46231 | TEIKIN NO. P 46256 | TEIKIN NO. B 46231 | TEIKIN NO. LFF 46231 LSF 46231 | | |
| | REFERENCE NO. 13101-68011 | REFERENCE NO. 13011-68010 13011-68020 13011-96601 13013-68020 | REFERENCE NO. 90999-73087 | REFERENCE NO. 11461-68010 | | | |
| | Surface Treatment Bore Clearance Tin Coated MRC: 0.080 mm MP: 25.00 mm | | | | | | |

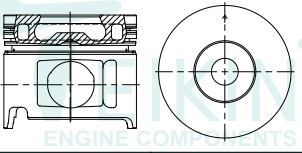
| ENGINE TYPE | PISTON | PISTON RING | PISTON PIN | PIN BUSHING | LINER | | LINER KIT SET |
|---|---|---|---|--|--|---------------|---|
| | | | | | FLANGED | NO FLANGE | |
| 2KD - FTV 2494 cc 4 cyl. FORTUNER HILUX HIACE | \emptyset 92.00 -19.5 CD 54.2 TL 82.2 | 1 - 2.0 1 - 1.5 1 - 3.0 | \emptyset 34.000 TL 65.00 | | TL 170.0 OD 96.0 FT 4.5 FD 101.0 | 165.0 96.0 | TEIKIN NO. LKSF 46348A LKSX 46348A LKSF46348AG LKSX46348AG |
| | TEIKIN NO. 46348A 46348AG | TEIKIN NO. R 46348 | TEIKIN NO. P 46348 | TEIKIN NO. B 46348 | TEIKIN NO. LSF 46348 LSX 46348 | | 173 |
| Surface Treatment Bore Clearance Tin Coated MRC: 0.060 mm MP: 6.00 mm | REFERENCE NO. 13101-0L020-01 13101-0L022 13101-30030 13101-30031 | REFERENCE NO. 13011-30030/1 13011-0L020/40 13011-30060/80 13013-30030/1 | REFERENCE NO. 90999-73145 | REFERENCE NO. | | | |
| 2L 2466 cc 4 cyl. | \emptyset 92.00 -1.5 CD 49.2 TL 86.2 | 1 - 2.0 HK 1 - 2.0 1 - 4.0 | \emptyset 27.000 TL 74.00 | | TL 160.5 OD 96.0 FT 3.5 +1.0 FD 100.7 | 160.5 96.0 | |
| | TEIKIN NO. 46240 46240A | TEIKIN NO. R 46240 | TEIKIN NO. P 46240 | TEIKIN NO. B 46226 | TEIKIN NO. LFF 46240 LSF 46240 LSX 46240 | | 174 |
| Surface Treatment Bore Clearance Tin Coated MRC: 0.050 mm MP: 17.00 mm | REFERENCE NO. 13101-54060 | REFERENCE NO. 13011-54040/60/61/62 13011-54090/100 13013-54060/1/2/100 13014-54100 | REFERENCE NO. 90999-70048 90999-73069 90999-73083 | REFERENCE NO. 11461-54030 11461-54060 | | | |
| 2L-II, 2L LATE 2466 cc 4 cyl. | \emptyset 92.00 -2.4 CD 44.3 TL 80.3 | 1 - 2.0 HK 1 - 2.0 1 - 4.0 | \emptyset 27.000 TL 70.00 | | TL 160.5 OD 96.0 FT 3.5 +1.0 FD 100.7 | 160.5 96.0 | |
| | TEIKIN NO. 46261 46261A | TEIKIN NO. R 46240 | TEIKIN NO. P 46261 | TEIKIN NO. B 46261 | TEIKIN NO. LFF 46240 LSF 46240 LSX 46240 | | 175 |
| Surface Treatment Bore Clearance Tin Coated MRC: 0.050 mm MP: 16.00 mm | REFERENCE NO. 13101-54070 | REFERENCE NO. 13011-54040/60/61/62 13011-54090/100 13013-54060/1/2/100 13014-54100 | REFERENCE NO. 90999-73114 | REFERENCE NO. 11461-54030 11461-54060 | | | |
| 2LT LATE 2466 cc 4 cyl. | \emptyset 92.00 -2.65 CD 44.3 TL 80.3 | 1 - 2.0 HK 1 - 2.0 1 - 4.0 | \emptyset 29.000 TL 74.00 | | TL 160.5 OD 96.0 FT 3.5 +1.0 FD 100.7 | 160.5 96.0 | |
| | TEIKIN NO. 46600 46600A 46600G 46600AG (46298) | TEIKIN NO. R 46240 | TEIKIN NO. P 46256 | TEIKIN NO. B 46256 | TEIKIN NO. LFF 46240 LSF 46240 LSX 46240 | | 176 |
| Surface Treatment Bore Clearance Tin Coated MRC: 0.050 mm MP: 16.00 mm | REFERENCE NO. 13101-54090 13101-54091 13101-54111 | REFERENCE NO. 13011-54040/60/61/62 13011-54090/100 13013-54060/1/2/100 13014-54100 | REFERENCE NO. 90999-73115 | REFERENCE NO. 11461-54030 11461-54060 | | | |

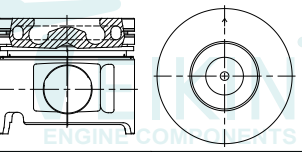
T







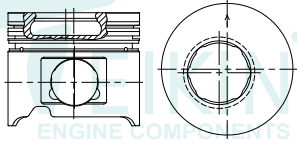

| ENGINE TYPE | PISTON | PISTON RING | PISTON PIN | PIN BUSHING | LINER | | | LINER KIT SET |
|---|--|---|---|--|--|---------------|--|---------------|
| | | | | | FLANGED | NO FLANGE | | |
| 2LT NEW-II 4 cyl.  | \varnothing 92.00 -3.0 CD 44.3 TL 80.3 | 1 - 2.0 HK 1 - 2.0 1 - 4.0 | \varnothing 27.000 TL 70.00  | | TL 160.5 OD 96.0 FT 3.5 +1.0 FD 100.7 | 160.5 96.0 | TEIKIN NO. LKFF 46351A LKSF 46351A LKSX 46351A | |
| | TEIKIN NO. 46351A | TEIKIN NO. R 46240 | TEIKIN NO. P 46261 | TEIKIN NO. B 46261 | TEIKIN NO. LFF 46240 LSF 46240 LSX 46240 | | | |
| | REFERENCE NO. 13101-54130-02 | REFERENCE NO. 13011-54040/60/61/62 13011-54090/100 13013-54060/1/2/100 13014-54100 | REFERENCE NO. 90999-73114 | REFERENCE NO. 11461-54030 11461-54060 | | | | |
| | Surface Treatment Tin Coated | Bore Clearance MRC: 0.050 mm MP: 16.00 mm | | | | | | |
| 2L-T, 2L-THE, 2L-TE 2466 cc 4 cyl.  | \varnothing 92.00 -3.70 CD 49.2 TL 86.2 | 1 - 2.0 HK 1 - 2.0 1 - 4.0 | \varnothing 29.000 TL 74.00  | | TL 160.5 OD 96.0 FT 3.5 +1.0 FD 100.7 | 160.5 96.0 | TEIKIN NO. LKFF 46602 LKSF 46602 LKSX 46602 LKFF 46602A LKSF 46602A LKSX 46602A | |
| | TEIKIN NO. 46602 46602A (46285) | TEIKIN NO. R 46240 | TEIKIN NO. P 46256 | TEIKIN NO. B 46602 | TEIKIN NO. LFF 46240 LSF 46240 LSX 46240 | | | |
| | REFERENCE NO. 13101-54080 13101-54050 13101-54030 13013-54030 | REFERENCE NO. 13011-54040/60/61/62 13011-54090/100 13013-54060/1/2/100 13014-54100 | REFERENCE NO. 90999-73094 90999-73118 | REFERENCE NO. 11461-54030 11461-54060 | | | | |
| | Surface Treatment Tin Coated | Bore Clearance MRC: 0.050 mm MP: 18.00 mm | | | | | | |
| 1HD-FT 4163 cc 6 cyl.  | \varnothing 94.00 -18.60 CD 49.4 TL 80.4 | 1 - 2.0 HK 1 - 2.0 1 - 4.0 | \varnothing 33.010 TL 73.00  | | TL 168.0 OD 98.0 FT 2.5 FD 103.0 | 168.0 98.0 | TEIKIN NO. LKSF 46362AG LKSX 46362AG LKFX 46362AG | |
| | TEIKIN NO. 46362AG | TEIKIN NO. R 46257 | TEIKIN NO. P 46268 | TEIKIN NO. B 46268 | TEIKIN NO. LSF 46257 LSX 46257 LFX 46257 | | | |
| | REFERENCE NO. 13101-17091-01 13101-17090 13101-17080 | REFERENCE NO. 13011-17010/1/20/30 13013-17010/1/20/30 | REFERENCE NO. 90999-73127 90999-73137 | REFERENCE NO. 11461-17010 | | | | |
| | Surface Treatment Tin Coated | Bore Clearance MRC: 0.060 mm MP: 11.00 mm | | | | | | |
| 1HD-FTE 4164 cc 6 cyl.  | \varnothing 94.00 -18.1 CD 49.4 TL 80.4 | 1 - 2.0 1 - 1.5 1 - 4.0 | \varnothing 33.000 TL 73.00  | | TL 168.0 OD 98.0 FT 2.5 FD 103.0 | 168.0 98.0 | TEIKIN NO. LKFX 46674AG LKSF 46674AG LKSX 46674AG | |
| | TEIKIN NO. 46674AG | TEIKIN NO. R 46674 | TEIKIN NO. P 46674 | TEIKIN NO. B 46268 | TEIKIN NO. LFX 46257 LSF 46257 LSX 46257 | | | |
| | REFERENCE NO. 13101-17110 13103-17110 | REFERENCE NO. 13011-17040 13013-17040 13014-17040 | REFERENCE NO. 90999-73127 90999-73137 | REFERENCE NO. 11461-17010 | | | | |
| | Surface Treatment Tin Coated | Bore Clearance MRC: 0.080 mm MP: 11.00 mm | | | | | | |

177

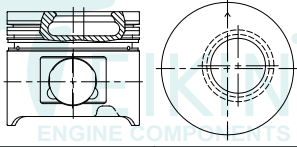

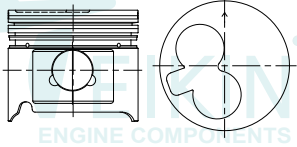

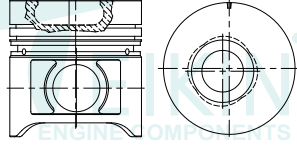

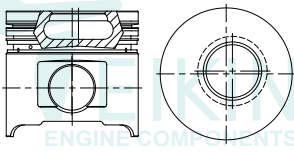

178

179

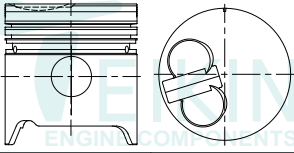
180

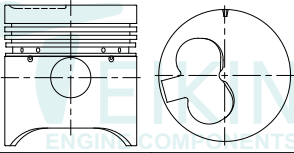
| ENGINE TYPE | PISTON | PISTON RING | PISTON PIN | PIN BUSHING | LINER | | | LINER KIT SET |
|---|---|--|---|--|--|---------------|--|---------------|
| | | | | | FLANGED | NO FLANGE | | |
| 1HD-T LATE 4163 cc 6 cyl.  Surface Treatment Bore Clearance Tin Coated MRC: 0.030 mm MP: 10.00 mm | \emptyset 94.00 -16.2 CD 49.7 TL 80.7 | 1 - 2.0 HK 1 - 2.0 1 - 4.0 | \emptyset 33.010 TL 73.00  | | TL 168.0 OD 98.0 FT 2.5 FD 103.0 | 168.0 98.0 | TEIKIN NO. LKSF 46268 LKXS 46268 LKFX 46268 LKSF 46268A LKXS 46268A LKFX 46268A | |
| | TEIKIN NO. 46268 46268A | TEIKIN NO. R 46257 | TEIKIN NO. P 46268 | TEIKIN NO. B 46268 | TEIKIN NO. LSF 46257 LSX 46257 LFX 46257 | | | |
| | REFERENCE NO. 13101-17040 | REFERENCE NO. 13011-17010/1/20/30 13013-17010/1/20/30 | REFERENCE NO. 90999-73127 90999-73137 | REFERENCE NO. 11461-17010 | | | | |
| | 181 | | | | | | | |
| 1HD-T-II 4163 cc 6 cyl.  Surface Treatment Bore Clearance Tin Coated MRC: 0.030 mm MP: 10.00 mm | \emptyset 94.00 -17.1 CD 49.8 TL 80.8 | 1 - 2.0 HK 1 - 2.0 1 - 4.0 | \emptyset 33.010 TL 73.00  | | TL 168.0 OD 98.0 FT 2.5 FD 103.0 | 168.0 98.0 | TEIKIN NO. LKSF 46325 LKXS 46325 LKFX 46325 LKSF 46325A LKXS 46325A LKFX 46325A | |
| | TEIKIN NO. 46325 46325A | TEIKIN NO. R 46257 | TEIKIN NO. P 46268 | TEIKIN NO. B 46268 | TEIKIN NO. LSF 46257 LSX 46257 LFX 46257 | | | |
| | REFERENCE NO. 13101-17020 | REFERENCE NO. 13011-17010/1/20/30 13013-17010/1/20/30 | REFERENCE NO. 90999-73127 90999-73137 | REFERENCE NO. 11461-17010 | | | | |
| | 182 | | | | | | | |
| 1HZ, 1PZ 4163 cc 6 cyl.  Surface Treatment Bore Clearance Tin Coated MRC: 0.050 mm MP: 9.80 mm | \emptyset 94.00 -1.4 CD 43.6 TL 80.6 | 1 - 2.0 HK 1 - 2.0 1 - 4.0 | \emptyset 29.000 TL 65.00  | | TL 168.0 OD 98.0 FT 2.5 FD 103.0 | 168.0 98.0 | TEIKIN NO. LKSF 46257 LKXS 46257 LKFX 46257 LKSF 46257A LKXS 46257A LKFX 46257A | |
| | TEIKIN NO. 46257 46257A | TEIKIN NO. R 46257 | TEIKIN NO. P 46257 | TEIKIN NO. B 46257 | TEIKIN NO. LSF 46257 LSX 46257 LFX 46257 | | | |
| | REFERENCE NO. 13101-17010 13101-17100 | REFERENCE NO. 13011-17010/1/20/30 13013-17010/1/20/30 | REFERENCE NO. 90999-73126 | REFERENCE NO. 11461-17010 | | | | |
| | 183 | | | | | | | |
| 11B 2977 cc 4 cyl.  Surface Treatment Bore Clearance Tin Coated MRC: 0.040 mm MP: 13.00 mm | \emptyset 95.00 -18.0 CD 63.4 TL 98.4 | 2 - 2.5 1 - 4.5 | \emptyset 34.000 TL 76.00  | | TL 190.0 OD 99.0 FT 2.5 +1.0 FD 104.6 | 192.0 99.0 | TEIKIN NO. LKFF 46287 LKSF 46287 LKXS 46287 LKFF 46287A LKSF 46287A LKXS 46287A | |
| | TEIKIN NO. 46287 46287A | TEIKIN NO. R 46124 | TEIKIN NO. P 46287 | TEIKIN NO. B 46130 | TEIKIN NO. LFF 46287 LSF 46287 LSX 46287 | | | |
| | REFERENCE NO. 13101-56042 13101-56041 | REFERENCE NO. 13011-56012/3 13011-56021/2/30 13015-56012/3 | REFERENCE NO. 90999-73099 | REFERENCE NO. 11461-56030 11462-56060 | | | | |
| | 184 | | | | | | | |

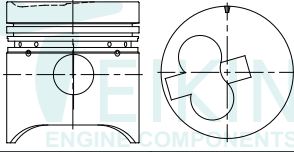





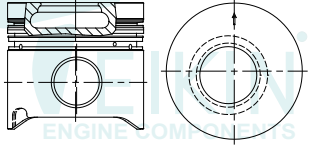

T

| ENGINE TYPE | PISTON | PISTON RING | PISTON PIN | PIN BUSHING | LINER | | LINER KIT SET |
|---|---|----------------------------------|---|----------------------|---|---------------|--|
| | | | | | FLANGED | NO FLANGE | |
| 11B-II 2977 cc 4 cyl.  Surface Treatment: Tin Coated Bore Clearance: MRC: 0.050 mm, MP: 14.00 mm | \emptyset 95.00 -20.3 CD 55.3 TL 90.3 | 1 - 2.5 HK 1 - 2.0 1 - 4.0 | \emptyset 32.000 TL 72.00  | | TL 190.0 OD 99.0 FT 2.5 +1.0 FD 104.6 | 192.0 99.0 | TEIKIN NO. LKFF 46608 LKSF 46608 LKSX 46608 LKFF 46608A LKSF 46608A LKSX 46608A REFERENCE NO. 13101-56060 13011-56040/1 13013-56040 13014-56040 13015-56040 REFERENCE NO. 90999-73116 90999-73124 REFERENCE NO. 11461-56030 11462-56060 |
| | TEIKIN NO. | TEIKIN NO. | TEIKIN NO. | TEIKIN NO. | TEIKIN NO. | | |
| | 46608 46608A (46295) | R 46608 | P 46254 | B 46254 | LFF 46287 LSF 46287 LSX 46287 | | |
| | REFERENCE NO. | REFERENCE NO. | REFERENCE NO. | REFERENCE NO. | REFERENCE NO. | | |
| | | | | | | | 185 |
| B LATE 2977 cc 4 cyl.  Surface Treatment: Tin Coated Bore Clearance: MRC: 0.070 mm, MP: 24.00 mm | \emptyset 95.00 -4.4 CD 52.2 TL 101.2 | 1 - 2.5 HK 1 - 2.0 1 - 4.0 | \emptyset 29.000 TL 74.00  | | TL 190.0 OD 102.0 FT 2.5 +1.0 FD 107.6 | | TEIKIN NO. LKFF 46626 LKSF 46626 LKFF 46626A LKSF 46626A REFERENCE NO. 13101-56050 13011-56040/1 13013-56040 13014-56040 13015-56040 REFERENCE NO. 90999-73065 90999-73121 90999-73131 REFERENCE NO. 11461-56020 |
| | TEIKIN NO. | TEIKIN NO. | TEIKIN NO. | TEIKIN NO. | TEIKIN NO. | | |
| | 46626 46626A (46304) | R 46608 | P 46256 | B 46124 | LFF 46124 LSF 46124 | | |
| | REFERENCE NO. | REFERENCE NO. | REFERENCE NO. | REFERENCE NO. | REFERENCE NO. | | |
| | | | | | | | 186 |
| B, BU-15 2977 cc 4 cyl. B OLD DYNA 1972  Surface Treatment: Tin Coated Bore Clearance: MRC: 0.100 mm, MP: 23.60 mm | \emptyset 95.00 -2.4 CD 52.2 TL 101.2 | 3 - 2.5 1 - 4.5 | \emptyset 29.000 TL 79.00  | | | | TEIKIN NO. REFERENCE NO. 13081-56010 |
| | TEIKIN NO. | TEIKIN NO. | TEIKIN NO. | TEIKIN NO. | TEIKIN NO. | | |
| | 46123 | | P 46123 | | | | |
| | REFERENCE NO. | REFERENCE NO. | REFERENCE NO. | REFERENCE NO. | REFERENCE NO. | | |
| | | | | | | | 187 |
| B, BU-30 2977 cc 4 cyl. B NEW  Surface Treatment: Tin Coated Bore Clearance: MRC: 0.100 mm, MP: 23.50 mm | \emptyset 95.00 -3.6 CD 52.2 TL 101.2 | 1 - 2.5 HK 1 - 2.5 1 - 4.5 | \emptyset 29.000 TL 79.00  | | TL 190.0 OD 102.0 FT 2.5 +1.0 FD 107.6 | | TEIKIN NO. LKFF 46124 LKSF 46124 REFERENCE NO. 13101-56020 13101-56021 13101-56030 13101-56031 REFERENCE NO. 13011-56012/3 13011-56021/2/30 13015-56012/3 REFERENCE NO. 90999-73065 90999-73121 90999-73131 REFERENCE NO. 11461-56020 |
| | TEIKIN NO. | TEIKIN NO. | TEIKIN NO. | TEIKIN NO. | TEIKIN NO. | | |
| | 46124 | R 46124 | P 46123 | B 46124 | LFF 46124 LSF 46124 | | |
| | REFERENCE NO. | REFERENCE NO. | REFERENCE NO. | REFERENCE NO. | REFERENCE NO. | | |
| | | | | | | | 188 |

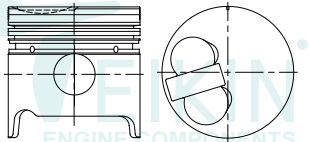
| ENGINE TYPE | PISTON | PISTON RING | PISTON PIN | PIN BUSHING | LINER | | LINER KIT SET |
|--|--|--|------------------------------------|--|--|----------------|--|
| | | | | | FLANGED | NO FLANGE | |
| 1KD-FTV-III 2982 cc 4 cyl. HILUX - LAND CRUISER PI (KDJ 12/15 - KUN26) 2009 - | \emptyset 96.00 -16.3 CD 49.6 TL 78.5 | 1 - 2.0 HK 1 - 1.5 1 - 3.0 | \emptyset 34.000 TL 73.00 | | TL 170.0 OD 99.0 FT 5.0 FD 105.0 | 170.0 99.0 | TEIKIN NO. LKSX 46698AG LKSF 46698AG 193 |
| | TEIKIN NO. 46698AG | TEIKIN NO. R 46675 | TEIKIN NO. P 46283 | TEIKIN NO. B 46675 | TEIKIN NO. LSX 46675 LSF 46675 | | |
| | REFERENCE NO. 13101-30150 13103-30150 13104-30150 13105-30150 | REFERENCE NO. 13011-30020/1/2 13011-30040/50/51 13013-30020/1/2 13013-30051 | | REFERENCE NO. 90999-73143 | REFERENCE NO. | | |
| | Surface Treatment Anodized Crown Moly Skirt | Bore Clearance MRC: 0.060 mm MP: 7.50 mm | | | | | |
| 1KZ-TE, NEW 2982 cc 4 cyl. | \emptyset 96.00 -2.4 CD 45.8 TL 80.7 | 1 - 2.0 HK 1 - 2.0 1 - 3.0 | \emptyset 34.000 TL 73.00 | | TL 170.0 OD 99.0 FT 5.0 FD 105.0 | 170.0 99.0 | TEIKIN NO. LKFF 46671AG LKSF 46671AG 194 |
| | TEIKIN NO. 46671AG | TEIKIN NO. R 46283 | TEIKIN NO. P 46283 | TEIKIN NO. B 46283 | TEIKIN NO. LFF 46283 LSF 46283 | | |
| | REFERENCE NO. 13101-67050 | REFERENCE NO. 13011-67030 13013-67030 13014-67030 13015-67030 | | REFERENCE NO. 90999-73136 90999-73143 | REFERENCE NO. 11461-78300 11461-78301 | | |
| | Surface Treatment Tin Coated Anodized Crown | Bore Clearance MRC: 0.050 mm MP: 14.00 mm | | | | | |
| 1KZ-TE, 1KZ 2982 cc 4 cyl. | \emptyset 96.00 -2.2 CD 45.7 TL 80.7 | 1 - 2.0 HK 1 - 2.0 1 - 3.0 | \emptyset 34.000 TL 73.00 | | TL 170.0 OD 99.0 FT 5.0 FD 105.0 | 170.0 99.0 | TEIKIN NO. LKFF 46283 LKSF 46283 LKFF 46283A LKSF 46283A LKFF 46283G LKSF 46283G LKFF 46283AG LKSF 46283AG 195 |
| | TEIKIN NO. 46283 46283A 46283G 46283AG | TEIKIN NO. R 46283 | TEIKIN NO. P 46283 | TEIKIN NO. B 46283 | TEIKIN NO. LFF 46283 LSF 46283 | | |
| | REFERENCE NO. 13101-67030 | REFERENCE NO. 13011-67030 13013-67030 13014-67030 13015-67030 | | REFERENCE NO. 90999-73136 90999-73143 | REFERENCE NO. 11461-78300 11461-78301 | | |
| | Surface Treatment Tin Coated Anodized Crown | Bore Clearance MRC: 0.030 mm MP: 14.00 mm | | | | | |
| 1Z 2953 cc 4 cyl. | \emptyset 96.00 -15.7 CD 56.5 TL 94.4 | 2 - 2.0 1 - 4.0 | \emptyset 32.000 TL 76.00 | | TL 182.5 OD 100.0 FT 8.0 FD 105.8 | 182.5 100.0 | TEIKIN NO. LKFF 46613 LKSF 46613 LKFF 46613A LKSF 46613A 196 |
| | TEIKIN NO. 46613 46613A (46306) | TEIKIN NO. R 46613 | TEIKIN NO. P 46613 | TEIKIN NO. B 46613 | TEIKIN NO. LFF 46613 LSF 46613 | | |
| | REFERENCE NO. 13101-78300 13101-96300 | REFERENCE NO. 13011-78300 | | REFERENCE NO. 90384-32950 90384-32951 | REFERENCE NO. 11461-78360 | | |
| | Surface Treatment Tin Coated | Bore Clearance MRC: 0.080 mm MP: 16.00 mm | | | | | |

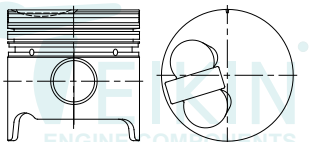
| ENGINE TYPE | PISTON | PISTON RING | PISTON PIN | PIN BUSHING | LINER | | LINER KIT SET |
|--|---|---|---|---|--|----------------|--|
| | | | | | FLANGED | NO FLANGE | |
| 3L 2779 cc 1988 4 cyl. | \emptyset 96.00 -2.3 CD 42.4 TL 80.4 | 1 - 2.0 HK 1 - 2.0 1 - 4.0 | \emptyset 29.000 TL 74.00 | | TL 190.0 OD 100.0 FT 2.5 +1.0 FD 107.6 | 190.0 100.0 | TEIKIN NO. LKFF 46256 LKSF 46256 LKX 46256 LKFF 46256A LKSF 46256A LKX 46256A |
| Surface Treatment Tin Coated Bore Clearance MRC: 0.050 mm MP: 18.00 mm | TEIKIN NO. 46256 46256A REFERENCE NO. 13101-54101 13101-54100 | TEIKIN NO. R 46256 REFERENCE NO. 13011-54120 13013-54120 | TEIKIN NO. P 46256 REFERENCE NO. 90999-73115 | TEIKIN NO. B 46256 REFERENCE NO. 90999-73115 | TEIKIN NO. LFF 46256 LSF 46256 LSX 46256 REFERENCE NO. 11461-54090 11461-54100 | | 197 |
| 2B 3168 cc 1977 4 cyl. | \emptyset 98.00 -3.5 CD 52.2 TL 101.1 | 1 - 2.5 HK 1 - 2.5 1 - 4.5 | \emptyset 29.000 TL 79.00 | | TL 190.0 OD 102.0 FT 2.5 +1.0 FD 107.6 | | TEIKIN NO. LKFF 46127 LKSF 46127 |
| Surface Treatment Tin Coated Bore Clearance MRC: 0.100 mm MP: 23.50 mm | TEIKIN NO. 46127 REFERENCE NO. 13101-57011 13101-57020 13101-57022 | TEIKIN NO. R 46127 REFERENCE NO. 13011-57010 | TEIKIN NO. P 46123 REFERENCE NO. 90999-73065 90999-73121 90999-73131 | TEIKIN NO. B 46124 REFERENCE NO. 90999-73065 90999-73121 90999-73131 | TEIKIN NO. LFF 46127 LSF 46127 REFERENCE NO. 11461-57010 | | 198 |
| 2Z NEW 3469 cc 4 cyl. | \emptyset 98.00 -17.2 CD 49.9 TL 87.9 | 2 - 2.0 1 - 4.0 | \emptyset 32.000 TL 77.00 | | TL 181.5 OD 101.0 FT 5.0 FD 107.0 | | TEIKIN NO. LKFF 46682 LKSF 46682 |
| Surface Treatment Tin Coated Bore Clearance MRC: 0.040 mm MP: 16.00 mm | TEIKIN NO. 46682 REFERENCE NO. 13101-78702 | TEIKIN NO. R 46682 REFERENCE NO. 13011-78700 13011-78701 13011-78760 | TEIKIN NO. P 46624 REFERENCE NO. 90384-32950 90384-32951 | TEIKIN NO. B 46613 REFERENCE NO. 90384-32950 90384-32951 | TEIKIN NO. LFF 46682 LSF 46682 REFERENCE NO. 11461-78400 11461-78700 | | 199 |
| 13Z 5244 cc 6 cyl. | \emptyset 98.00 -17.7 CD 56.5 TL 94.4 | 2 - 2.0 1 - 4.0 | \emptyset 32.000 TL 77.00 | | TL 181.5 OD 101.0 FT 5.0 FD 107.0 | | TEIKIN NO. LKFF 46685 LKSF 46685 |
| Surface Treatment Tin Coated Bore Clearance MRC: 0.080 mm MP: 16.00 mm | TEIKIN NO. 46685 REFERENCE NO. 13101-78761 | TEIKIN NO. R 46685 REFERENCE NO. 13011-78700 13011-78701 13011-78760 | TEIKIN NO. P 46624 REFERENCE NO. 90384-32950 90384-32951 | TEIKIN NO. B 46685 REFERENCE NO. 90384-32950 90384-32951 | TEIKIN NO. LFF 46685 LSF 46685 REFERENCE NO. 11461-78700 | | 200 |

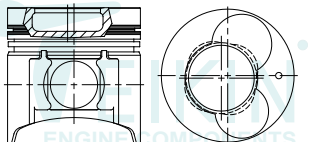
T

| ENGINE TYPE | PISTON | PISTON RING | PISTON PIN | PIN BUSHING | LINER | | | LINER KIT SET |
|---|---|--|---|---|--|----------------|--|---------------|
| | | | | | FLANGED | NO FLANGE | | |
| 14B-T 3660 cc 4 cyl.  | \emptyset 102.00 -19.1 CD 59.8 TL 94.8 | 1 - 3.0 HK 1 - 2.0 1 - 4.0 | \emptyset 34.000 TL 79.00  | | TL 187.5 OD 106.0 FT 2.5 +1.0 FD 111.7 | 197.0 106.0 | TEIKIN NO. LKFF 46625 LKSF 46625 LKXS 46625 LKFF 46625A LKSF 46625A LKXS 46625A | |
| | TEIKIN NO. 46625 46625A (46292) | TEIKIN NO. R 46625 | TEIKIN NO. P 46625 | TEIKIN NO. B 46625 | TEIKIN NO. LFF 46128 LSF 46128 LSX 46128 | | | |
| | REFERENCE NO. 13101-58060 | REFERENCE NO. 13011-58060 | REFERENCE NO. 90999-73100 | REFERENCE NO. 11461-58010 11461-58020 11461-58040 | | | | |
| | Surface Treatment Bore Clearance Tin Coated MRC: 0.120 mm MP: 16.00 mm | 205 | | | | | | |
| 3B 3431 cc 4 cyl. 1981  | \emptyset 102.00 -5.0 CD 52.2 TL 101.2 | 1 - 2.5 HK 1 - 2.5 1 - 4.5 | \emptyset 32.000 TL 83.40  | | TL 187.5 OD 106.0 FT 2.5 +1.0 FD 111.7 | 197.0 106.0 | TEIKIN NO. LKFF 46128 LKSF 46128 LKXS 46128 LKFF 46128A LKSF 46128A LKXS 46128A | |
| | TEIKIN NO. 46128 46128A | TEIKIN NO. R 46128 | TEIKIN NO. P 46128 | TEIKIN NO. B 46128 | TEIKIN NO. LFF 46128 LSF 46128 LSX 46128 | | | |
| | REFERENCE NO. 13101-58011 13101-58012 | REFERENCE NO. 13011-58010/1 | REFERENCE NO. 90999-73088 90999-73132 | REFERENCE NO. 11461-58010 11461-58020 11461-58040 | | | | |
| | Surface Treatment Bore Clearance Tin Coated MRC: 0.060 mm MP: 25.00 mm | 206 | | | | | | |
| 3B-II 3431 cc 4 cyl.  | \emptyset 102.00 -5.1 CD 55.2 TL 101.2 | 1 - 2.5 HK 1 - 2.0 1 - 4.0 | \emptyset 32.000 TL 72.00  | | TL 187.5 OD 106.0 FT 2.5 +1.0 FD 111.7 | 197.0 106.0 | TEIKIN NO. LKFF 46622 LKSF 46622 LKXS 46622 LKFF 46662A LKSF 46662A LKXS 46662A | |
| | TEIKIN NO. 46622 46622A (46327) | TEIKIN NO. R 46254 | TEIKIN NO. P 46254 | TEIKIN NO. B 46254 | TEIKIN NO. LFF 46128 LSF 46128 LSX 46128 | | | |
| | REFERENCE NO. 13101-58050 | REFERENCE NO. 13101-58050/1/70 13103-58050/70 13014-58050/70 13015-58050/70 | REFERENCE NO. 90999-73116 90999-73124 | REFERENCE NO. 11461-58010 11461-58020 11461-58040 | | | | |
| | Surface Treatment Bore Clearance Tin Coated MRC: 0.030 mm MP: 16.00 mm | 207 | | | | | | |
| RINO 4 cyl. PS 135  | \emptyset 104.00 -18.7 CD 60.2 TL 106.2 | 1 - 2.5 1 - 2.0 1 - 4.0 | \emptyset 37.000 TL 84.50  | | | | TEIKIN NO. | |
| | TEIKIN NO. 46339 46339A | | TEIKIN NO. P 46339 | | | | | |
| | REFERENCE NO. 13211-78120 | | | | | | | |
| | Surface Treatment Bore Clearance Tin Coated MRC: 0.090 mm MP: 23.40 mm | 208 | | | | | | |

T

| ENGINE TYPE | PISTON | PISTON RING | PISTON PIN | PIN BUSHING | LINER | | LINER KIT SET |
|--|---|--|--|--|--|----------------|---------------------------------|
| | | | | | FLANGED | NO FLANGE | |
| 2D NEW 6494 cc 1977 6 cyl. | \emptyset 105.00 -5.1 CD 73.2 TL 133.1 | 1 - 3.0 HK 2 - 2.5 1 - 5.0 | \emptyset 34.000 TL 88.50 | | TL 233.0 OD 115.5 FT 10.0 +1.0 FD 121.0 | | TEIKIN NO. LKFF 46244 |
| | TEIKIN NO. 46244 | TEIKIN NO. R 46244 | TEIKIN NO. P 46242 | TEIKIN NO. B 46244 | TEIKIN NO. LFF 46244 | | 209 |
| Surface Treatment Tin Coated Bore Clearance MRC: 0.100 mm MP: 32.00 mm | REFERENCE NO. 13101-77020 13211-77016 13211-77020/1 | REFERENCE NO. 13011-77040 13011-77041 13011-77050 | REFERENCE NO. 90999-73080 90999-73081 | REFERENCE NO. 11461-77021 | | | |
| 2D OLD 6494 cc 1965-76 6 cyl. | \emptyset 105.00 -10.1 CD 73.0 TL 138.0 | 3 - 3.0 2 - 5.0 | \emptyset 34.000 TL 88.50 | | TL 242.0 OD 115.5 FT 10.0 FD 120.0 | | |
| | TEIKIN NO. 46242 | TEIKIN NO. R 46242 | TEIKIN NO. P 46242 | TEIKIN NO. B 46242 | TEIKIN NO. LFF 46242 | | 210 |
| Surface Treatment Tin Coated Bore Clearance MRC: 0.100 mm MP: 23.00 mm | REFERENCE NO. 13101-77012 13101-77013 | REFERENCE NO. 13011-77010 13011-77020/1/2/3 | REFERENCE NO. 90999-70004 90999-70005 | REFERENCE NO. 11461-77015 11461-77040 | | | |
| 15BF 4104 cc DYNA BU142, BU 212 BU222 4 cyl. 1995-2002 | \emptyset 108.00 -21.3 CD 59.5 TL 94.5 | 1 - 3.0 HK 1 - 2.0 1 - 4.0 | \emptyset 34.000 TL 73.00 | | TL 193.0 OD 112.0 FT 5.0 FD 115.0 | 193.0 112.0 | |
| | TEIKIN NO. 46655A | TEIKIN NO. R 46655 | TEIKIN NO. P 46283 | TEIKIN NO. B 46655 | TEIKIN NO. LSF 46655 LSX 46655 | | 211 |
| Surface Treatment Tin Coated Bore Clearance MRC: 0.090 mm MP: 13.00 mm | REFERENCE NO. 13101-58090 13101-58080 | REFERENCE NO. 13011-58090 13013-58090 13014-58090 13015-58090 | REFERENCE NO. 90999-73134 | REFERENCE NO. 11461-58090 | | | |
| 15BF-T 4104 cc 4 cyl. | \emptyset 108.00 -22.2 CD 59.5 TL 94.5 | 1 - 3.0 HK 1 - 2.0 1 - 4.0 | \emptyset 34.000 TL 73.00 | | TL 193.0 OD 112.0 FT 5.0 FD 115.0 | 193.0 112.0 | |
| | TEIKIN NO. 46656AG | TEIKIN NO. R 46655 | TEIKIN NO. P 46283 | TEIKIN NO. B 46655 | TEIKIN NO. LFF 46655 LSX 46655 | | 212 |
| Surface Treatment Tin Coated Bore Clearance MRC: 0.100 mm MP: 14.00 mm | REFERENCE NO. 13101-58091 13101-58101 | REFERENCE NO. 13011-58090 13013-58090 13014-58090 13015-58090 | REFERENCE NO. 90999-73134 | REFERENCE NO. 11461-58090 | | | |



| ENGINE TYPE | PISTON | PISTON RING | PISTON PIN | PIN BUSHING | LINER | | LINER KIT SET |
|---|---|-------------------------------|---|----------------------|--|-----------|----------------------------------|
| | | | | | FLANGED | NO FLANGE | |
| S05C-II 4613 cc 4 cyl. | \emptyset 114.00 -20.0 CD 60.5 TL 103.5 | 1 - 2.5 1 - 2.0 1 - 4.0 | \emptyset 37.000 TL 85.00  | | TL 186.5 OD 117.0 FT 8.0 FD 122.0 | | TEIKIN NO. LKFF 46381A |
| | TEIKIN NO. | TEIKIN NO. | TEIKIN NO. | TEIKIN NO. | TEIKIN NO. | | |
| | 46381A | R 46672 | P 36127 | B 46381 | LFF 46672 | | |
| | REFERENCE NO. | REFERENCE NO. | | REFERENCE NO. | REFERENCE NO. | | |
| Surface Treatment Bore Clearance Tin Coated MRC: 0.060 mm MP: 20.50 mm | 13218-78021 13218-78020 13216-2983 | 13011-78030 13011-78031 | | 13271-89101 | 11461-78090 11461-78100 11461-78110 | | 213 |

SUITABLE FOR

VOLGA

GASOLINE

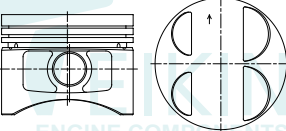

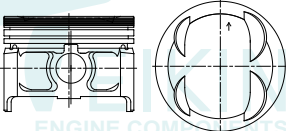
| ENGINE TYPE | PISTON | PISTON RING | PISTON PIN | PIN BUSHING | LINER | | LINER KIT SET |
|---|---|--------------------------------|---|-------------|---------|-----------|---------------|
| | | | | | FLANGED | NO FLANGE | |
| GAZ 4062.10 4 cyl. | \varnothing 92.00 -5.0 CD 38.0 TL 69.9 | 1 - 1.5 1 - 2.0 1 - 3.5 | \varnothing 22.000 TL 64.00  | | | | TEIKIN NO. |
|  | TEIKIN NO. 60102 | | TEIKIN NO. P 43220 | | | | |
| Surface Treatment Bore Clearance Tin Coated MRC: 0.030 mm MP: 13.00 mm | REFERENCE NO. KS : 40 075 600 | | | | | | 1 |
| 405 4 cyl. | \varnothing 95.55 -1.30 CD 38.1 TL 69.9 | 1 - 1.75 1 - 2.0 1 - 3.5 | \varnothing 22.000 TL 64.00  | | | | TEIKIN NO. |
|  | TEIKIN NO. 60103 | | TEIKIN NO. P 43220 | | | | |
| Surface Treatment Bore Clearance None MRC: 0.030 mm MP: 16.00 mm | REFERENCE NO. | | | | | | 2 |











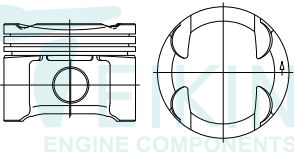

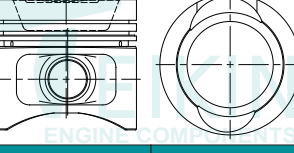

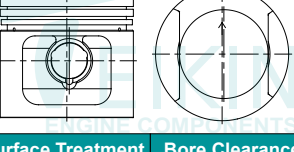

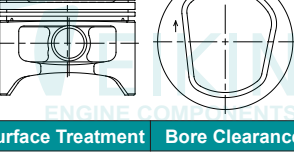
SUITABLE FOR

VOLKSWAGEN

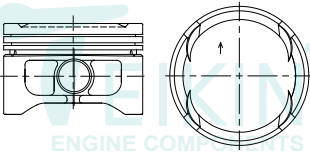
GASOLINE

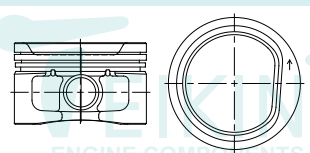

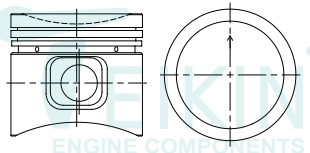
| ENGINE TYPE | PISTON | PISTON RING | PISTON PIN | PIN BUSHING | LINER | | LINER KIT SET |
|--|--|--------------------------------|---|-------------|---------|-----------|---------------|
| | | | | | FLANGED | NO FLANGE | |
| EA111-II 999 cc 16V 4 cyl. | \emptyset 67.11 -3.12 CD 31.3 TL 49.75 | 1 - 1.2 1 - 1.5 1 - 2.0 | \emptyset 17.000 TL 45.00  | | | | TEIKIN NO. |
|  | TEIKIN NO. 48213 | | TEIKIN NO. P 48210 | | | | |
| Surface Treatment Bore Clearance Tin Coated MRC: 0.025 mm MP: 6.00 mm | REFERENCE NO. MAHLE: E70550 | | | | | | 5 |
| 2G / AAV / HK 1272 cc HW / MH / NU / NZ 4 cyl. | \emptyset 75.00 -16.6 CD 42.9 TL 69.9 | 1 - 1.75 1 - 2.0 1 - 3.0 | \emptyset 20.000 TL 54.00  | | | | TEIKIN NO. |
|  | TEIKIN NO. 48605 | | TEIKIN NO. P 48605 | | | | |
| Surface Treatment Bore Clearance Tin Coated MRC: 0.030 mm MP: 11.00 mm | REFERENCE NO. KS: 93 896 600 MAHLE: 029 73 00 | | | | | | 6 |
| ET/ZF/EP 1981 -ON 1297 cc GOLF II CL 1300 GOLF 1300L, LS, GL, CiTi JETTA GL & GX, FOX 1.3 PASSAT 1300 L & LS 4 cyl. | \emptyset 75.00 -2.9 CD 39.5 TL 71.5 | 1 - 1.5 1 - 1.8 1 - 3.0 | \emptyset 20.000 TL 56.58  | | | | TEIKIN NO. |
|  | TEIKIN NO. 48107 | | TEIKIN NO. P 42165 | | | | |
| Surface Treatment Bore Clearance Tin Coated MRC: 0.030 mm MP: 4.00 mm | REFERENCE NO. KS : 93 892 600 | | | | | | 7 |
| AEA / AEE / AHS / ALM 1598 cc 4 cyl. | \emptyset 76.50 -7.8 CD 30.9 TL 60.2 | 1 - 1.2 1 - 1.5 1 - 2.5 | \emptyset 17.000 TL 52.00  | | | | TEIKIN NO. |
|  | TEIKIN NO. 48607 | | TEIKIN NO. P 48209 | | | | |
| Surface Treatment Bore Clearance Tin Coated MRC: 0.030 mm MP: 15.00 mm | REFERENCE NO. KS: 94 553 600 MAHLE: 030 42 00 | | | | | | 8 |

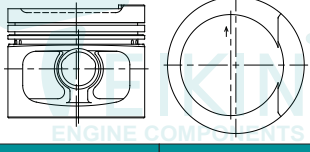
| ENGINE TYPE | PISTON | PISTON RING | PISTON PIN | PIN BUSHING | LINER | | LINER KIT SET |
|---|--|--------------------------------|---|-------------|---------|-----------|---------------|
| | | | | | FLANGED | NO FLANGE | |
| AFH / AFK / AHW 1390 cc AKQ / APE / AUA / AXP 4 cyl. | \emptyset 76.50 -2.0 CD 29.0 TL 50.0 | 1 - 1.2 1 - 1.5 1 - 2.5 | \emptyset 17.000 TL 54.00  | | | | TEIKIN NO. |
|  | TEIKIN NO. 48608 | TEIKIN NO. P 48608 | | | | | |
| Surface Treatment Bore Clearance Tin Coated MRC: 0.030 mm Moly Skirt MP: 7.00 mm | REFERENCE NO. KS: 99 562 600 MAHLE: 03 061 00 | | | | | | |
| LUPO 1598 cc LUPO POLO CROSS FOX SEAT IBIZA 2001-2007 4 cyl. | \emptyset 76.50 -7.0 CD 28.7 TL 47.2 | 1 - 1.2 1 - 1.5 1 - 2.5 | \emptyset 17.000 TL 52.00  | | | | TEIKIN NO. |
|  | TEIKIN NO. 48209 | TEIKIN NO. P 48209 | | | | | |
| Surface Treatment Bore Clearance Moly Skirt MRC: 0.030 mm MP: 5.00 mm | REFERENCE NO. 032 107 065 Q | | | | | | |
| FR/JB, FP WV 1598 cc YN, YP, YV 4 cyl. GOLF 1600 GTS CITI GOLF SPORT AUDI 80GL, 100LS & 1004 | \emptyset 79.50 -6.1 CD 41.8 TL 73.8 | 1 - 1.8 1 - 2.0 1 - 4.0 | \emptyset 22.000 TL 55.00  | | | | TEIKIN NO. |
|  | TEIKIN NO. 48102 | TEIKIN NO. P 48102 | | | | | |
| Surface Treatment Bore Clearance Tin Coated MRC: 0.010 mm MP: 12.20 mm | REFERENCE NO. KS : 93 356 600 | | | | | | |
| 1F / ABN / DT / EW 1595 cc EZ / EZA / JU / PN / RE / RL 4 cyl. | \emptyset 81.00 -2.3 CD 35.6 TL 66.8 | 1 - 1.5 1 - 1.75 1 - 3.0 | \emptyset 20.000 TL 57.00  | | | | TEIKIN NO. |
|  | TEIKIN NO. 48604 | TEIKIN NO. P 42668 | | | | | |
| Surface Treatment Bore Clearance Tin Coated MRC: 0.030 mm MP: 4.00 mm | REFERENCE NO. KS: 93 872 600 MAHLE: 034 76 00 | | | | | | |







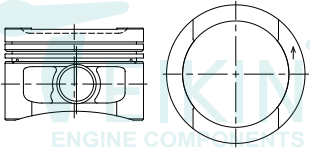

SUITABLE FOR

VOLKSWAGEN

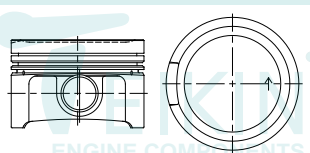
GASOLINE

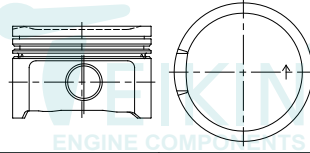

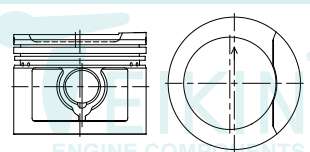
| ENGINE TYPE | PISTON | PISTON RING | PISTON PIN | PIN BUSHING | LINER | | LINER KIT SET |
|---|---|--------------------------------|--------------------------------|---|---------|-----------|---------------|
| | | | | | FLANGED | NO FLANGE | |
| ADP / AEK / AFT 1595 cc AHL / AKL / ARM 4 cyl. | \emptyset 81.01 -3.0 CD 32.7 TL 53.8 | 1 - 1.2 1 - 1.5 1 - 2.0 | \emptyset 20.000 TL 57.00 |  | | | TEIKIN NO. |
|  | TEIKIN NO. | | TEIKIN NO. | | | | |
| Surface Treatment Tin Coated Bore Clearance Moly Skirt MRC: 0.025 mm MP: 7.00 mm | REFERENCE NO. KS: 94 503 700 MAHLE: 033 01 00 | | P 48609 | | | | 13 |
| AEB 1800 cc PASSAT F.I., DOHC 20V 4 cyl. | \emptyset 81.00 -1.5 CD 32.7 TL 53.7 | 1 - 1.5 1 - 1.75 1 - 2.0 | \emptyset 20.000 TL 59.00 |  | | | TEIKIN NO. |
|  | TEIKIN NO. | | TEIKIN NO. | | | | |
| Surface Treatment Moly Skirt Bore Clearance MRC: 0.020 mm MP: 6.00 mm | REFERENCE NO. 06A-107-065J KS : 99 933 600 | | P 51101 | | | | 14 |
| AEB-II 1781 cc TT F.I., DOHC 20V 4 cyl. | \emptyset 81.00 -1.9 CD 32.7 TL 53.7 | 1 - 1.5 1 - 1.75 1 - 2.0 | \emptyset 19.000 TL 50.00 |  | | | TEIKIN NO. |
|  | TEIKIN NO. | | TEIKIN NO. | | | | |
| Surface Treatment Anodized Crown Bore Clearance Moly Skirt MRC: 0.020 mm MP: 8.00 mm | REFERENCE NO. 06B-107-065N | | P 48205 | | | | 15 |
| E-II, ABS KAT, DS, DX 1781 cc EV, GU, GX, PF, RG KAT 4 cyl. GOLF Gti, GOLF Gti JETTA Gli, JETTA II CII 1983 - ON | \emptyset 81.00 +1.35 CD 31.9 TL 62.4 | 1 - 1.5 1 - 1.75 1 - 3.0 | \emptyset 20.000 TL 56.58 |  | | | TEIKIN NO. |
|  | TEIKIN NO. | | TEIKIN NO. | | | | |
| Surface Treatment Tin Coated Bore Clearance MRC: 0.030 mm MP: 4.50 mm | REFERENCE NO. KS : 93 928 600 | | P 42165 (48106) | | | | 16 |

| ENGINE TYPE | PISTON | PISTON RING | PISTON PIN | PIN BUSHING | LINER | | LINER KIT SET |
|--|--|--------------------------------|------------------------------------|-------------|---------|-----------|---------------|
| | | | | | FLANGED | NO FLANGE | |
| JS KAT 1994 cc PASSAT 2.0 1983-88 115 PS EZ HM 4 cyl. | \emptyset 81.01 +2.5 CD 35.5 TL 66.8 | 1 - 1.5 1 - 1.75 1 - 3.0 | \emptyset 20.000 TL 56.58 | | | | TEIKIN NO. |
| | TEIKIN NO. 48201 | TEIKIN NO. P 42165 | | | | | |
| Surface Treatment Bore Clearance Tin Coated MRC: 0.030 mm MP: 3.50 mm | REFERENCE NO. KS : 93 871 600 | | | | | | |
| | | | | | | | |
| PL 4 KAT 1781 cc KR 4 V 1985-92 GOLF, JETTA 1986-91 4 cyl. | \emptyset 81.00 -3.9 CD 34.0 TL 63.0 | 1 - 1.5 1 - 1.75 1 - 3.0 | \emptyset 20.000 TL 56.58 | | | | TEIKIN NO. |
| | TEIKIN NO. 48600 (48202) | TEIKIN NO. P 42165 | | | | | |
| Surface Treatment Bore Clearance Tin Coated MRC: 0.020 mm MP: 6.50 mm | REFERENCE NO. KS : 93 117 600 | | | | | | |
| | | | | | | | |
| AAM / ADF / DS / EX / RP 1781 cc 4 cyl. | \emptyset 81.01 -8.0 CD 32.1 TL 62.5 | 1 - 1.5 1 - 1.75 1 - 3.0 | \emptyset 20.000 TL 57.00 | | | | TEIKIN NO. |
| | TEIKIN NO. 48609 | TEIKIN NO. P 48609 | | | | | |
| Surface Treatment Bore Clearance Tin Coated MRC: 0.030 mm MP: 4.00 mm | REFERENCE NO. KS: 93 876 600 MAHLE: 034 78 00 | | | | | | |
| | | | | | | | |
| 2.0 L LATE 4 cyl. | \emptyset 82.50 -6.7 CD 30.0 TL 51.0 | 1 - 1.2 1 - 1.5 1 - 2.0 | \emptyset 19.000 TL 42.00 | | | | TEIKIN NO. |
| | TEIKIN NO. 48215 | TEIKIN NO. P 48215 | | | | | |
| Surface Treatment Bore Clearance Moly Skirt MRC: 0.030 mm MP: 8.00 mm | REFERENCE NO. 06A-107-065-AE | | | | | | |
| | | | | | | | |











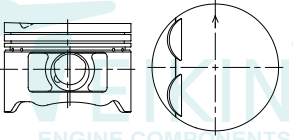

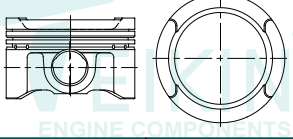

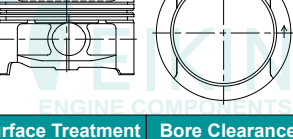

SUITABLE FOR

VOLKSWAGEN

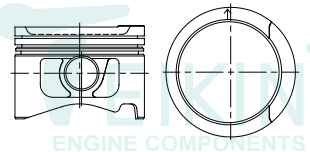
GASOLINE

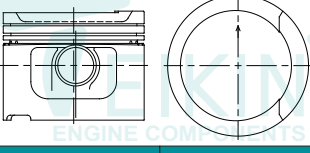

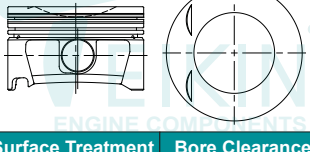
| ENGINE TYPE | PISTON | PISTON RING | PISTON PIN | PIN BUSHING | LINER | | LINER KIT SET |
|--|---|-------------------------------|---|-------------|---------|-----------|---------------|
| | | | | | FLANGED | NO FLANGE | |
| 9A, 9A 4V KAT 1984 cc 4 cyl. PASSAT, JETTA Gli GOLF Gti F.I., DOHC4 1990-93 | \emptyset 82.50 +0.6 CD 29.8 TL 58.4 | 1 - 1.2 1 - 1.5 1 - 2.0 | \emptyset 20.000 TL 56.58  | | | | TEIKIN NO. |
|  | TEIKIN NO. 48111 | | TEIKIN NO. P 42165 | | | | |
| Surface Treatment Bore Clearance Tin Coated MRC: 0.020 mm Anodized Crown MP: 10.00 mm | REFERENCE NO. 053-107 065F KS: 91 504 700 | | | | | | 21 |
| ABA 1984 cc 4 cyl. PASSAT, CABRIO GTI F.I., SOHC4 1993-97 | \emptyset 82.50 -7.35 CD 31.8 TL 51.8 | 1 - 1.2 1 - 1.5 1 - 2.0 | \emptyset 21.000 TL 56.00  | | | | TEIKIN NO. |
|  | TEIKIN NO. 48113 | | TEIKIN NO. P 38151 | | | | |
| Surface Treatment Bore Clearance Chromated MRC: 0.020 mm Moly Skirt MP: 5.40 mm | REFERENCE NO. 037-107-065M | | | | | | 22 |
| ABA-II 1984 cc 4 cyl. GOLF III, JETTA III 1993-95 F.I., SOHC 8V | \emptyset 82.50 -5.5 CD 30.6 TL 50.6 | 1 - 1.2 1 - 1.5 1 - 2.0 | \emptyset 21.000 TL 56.00  | | | | TEIKIN NO. |
|  | TEIKIN NO. 48207 | | TEIKIN NO. P38151 | | | | |
| Surface Treatment Bore Clearance Chromated MRC: 0.020 mm Moly Skirt MP: 5.40 mm | REFERENCE NO. 023-107-065A | | | | | | 23 |
| AEG 1984 cc 4 cyl. NEW BEETLE GOLF JETTA F.I., DOHC 8V 1998-2002 | \emptyset 82.50 -6.5 CD 30.0 TL 51.0 | 1 - 1.2 1 - 1.5 1 - 2.0 | \emptyset 19.990 TL 53.00  | | | | TEIKIN NO. |
|  | TEIKIN NO. 48203 | | TEIKIN NO. P 44340 | | | | |
| Surface Treatment Bore Clearance Moly Skirt MRC: 0.020 mm MP: 7.00 mm | REFERENCE NO. 058-107-065 | | | | | | 24 |

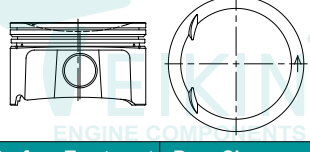
| ENGINE TYPE | PISTON | PISTON RING | PISTON PIN | PIN BUSHING | LINER | | LINER KIT SET |
|--|--|-------------------------------|---|-------------|---------|-----------|---------------|
| | | | | | FLANGED | NO FLANGE | |
| 2.5 / 2.6 MICROBUS 5 cyl. | \emptyset 82.50 +1.0 CD 29.4 TL 59.4 | 2 - 1.5 1 - 2.0 | \emptyset 20.000 TL 56.58  | | | | TEIKIN NO. |
|  | TEIKIN NO. 48206 | | TEIKIN NO. P 42165 | | | | |
| Surface Treatment Bore Clearance Tin Coated MRC: 0.030 mm MP: 11.50 mm | REFERENCE NO. | | | | | | |
| | | | | | | | |
| 2E / ADY / AGG 1984 cc 4 cyl. | \emptyset 82.50 +0.9 CD 30.9 TL 62.9 | 1 - 1.2 1 - 1.5 1 - 2.0 | \emptyset 21.000 TL 59.00  | | | | TEIKIN NO. |
|  | TEIKIN NO. 48610 | | TEIKIN NO. P 45131 | | | | |
| Surface Treatment Bore Clearance Tin Coated MRC: 0.030 mm MP: 6.00 mm | REFERENCE NO. KS: 91 128 600 | | | | | | |
| | | | | | | | |
| BPY / CBFA / CCTA 1998 cc 4 cyl. | \emptyset 82.50 -6.2 CD 29.6 TL 50.6 | 1 - 1.2 1 - 1.5 1 - 2.0 | \emptyset 20.000 TL 59.00  | | | | TEIKIN NO. |
|  | TEIKIN NO. 48611A | | TEIKIN NO. P 51101 | | | | |
| Surface Treatment Bore Clearance Moly Skirt MRC: 0.030 mm MP: 7.00 mm | REFERENCE NO. 06D107066C | | | | | | |
| | | | | | | | |
| BGP/BPQ 2480 cc 5 cyl. BORA VENTO JETTA 2.5L | \emptyset 82.50 -5.5 CD 29.3 TL 50.3 | 1 - 1.2 1 - 1.5 1 - 2.0 | \emptyset 19.000 TL 44.00  | | | | TEIKIN NO. |
|  | TEIKIN NO. 48208 | | TEIKIN NO. P 48208 | | | | |
| Surface Treatment Bore Clearance Moly Skirt MRC: 0.030 mm Anodized Crown MP: 7.50 mm 1st Ring Anodized | REFERENCE NO. 07K107065B MAHLE: 82L113 | | | | | | |
| | | | | | | | |







SUITABLE FOR

VOLKSWAGEN

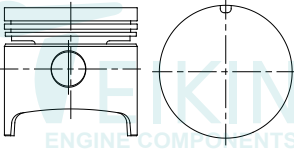
GASOLINE

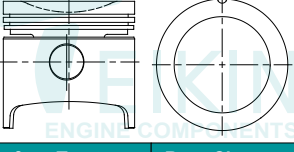

| ENGINE TYPE | PISTON | PISTON RING | PISTON PIN | PIN BUSHING | LINER | | LINER KIT SET |
|--|---|--------------------|---|-------------|---------|-----------|---------------|
| | | | | | FLANGED | NO FLANGE | |
| 1600-HIGH, 311 1584 cc SEDAN BRASILIA MOT 1600 (HIGH COMPRESSION) AIR-COOLED 1972-1992  | \varnothing 85.50 CD 39.5 TL 82.4 | 2 - 2.0 1 - 5.0 | \varnothing 22.000 TL 72.00  | | | | TEIKIN NO. |
| Surface Treatment Tin Coated Bore Clearance MRC: 0.052 mm MP: 24.50 mm | TEIKIN NO. 48108 REFERENCE NO. 311-107-12F KS: 91 322 701 | | TEIKIN NO. P 46199 | | | | 29 |
| 1600-LOW, AM 1584 cc SEDAN BRASILIA COMBI, SAFARI Y HARMIGA MOT 1600 (LOW COMPRESSION) 1971-1992 AIR-COOLED  | \varnothing 85.50 CD 39.5 TL 82.5 | 2 - 2.0 1 - 5.0 | \varnothing 22.000 TL 72.00  | | | | TEIKIN NO. |
| Surface Treatment Tin Coated Bore Clearance MRC: 0.052 mm MP: 24.50 mm | TEIKIN NO. 48109 REFERENCE NO. 311-107-112J KS : 91 320 701 | | TEIKIN NO. P 46199 | | | | 30 |





SUITABLE FOR

VOLKSWAGEN

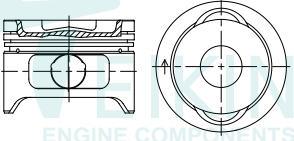

DIESEL



| ENGINE TYPE | PISTON | PISTON RING | PISTON PIN | PIN BUSHING | LINER | | LINER KIT SET | |
|--|--|-------------------------------|---|-------------|---------|-----------|---|------------------------------|
| | | | | | FLANGED | NO FLANGE | | |
| DJ 2109 cc 4 cyl. MICROBUS WATER COOLED FUEL INJECTION  | \varnothing 94.00 -9.1 CD 36.8 TL 66.8 | 1 - 1.8 1 - 2.0 1 - 3.5 | \varnothing 24.000 TL 64.00  | | | | TEIKIN NO. 48112 REFERENCE NO. KS : 90 129 600 | TEIKIN NO. P 48101 |
| Surface Treatment Tin Coated | Bore Clearance MRC: 0.030 mm MP: 14.50 mm | | | | | | 35 | |

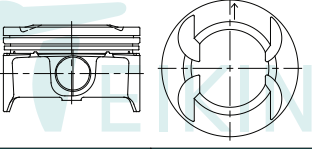
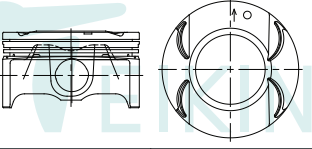

ADDENDUM TO TEIKIN CATALOG VOL.18 DATED SEPTEMBER 08, 2017

| ENGINE TYPE | PISTON | PISTON RING | PISTON PIN | PIN BUSHING | LINER | | LINER KIT SET |
|---|--|-------------------------------|--------------------------------|-------------|---------|------------------------------------|---------------|
| | | | | | FLANGED | NO FLANGE | |
| CHEVROLET ONIX 1.4L NF 8V 4 cyl. | \emptyset 77.60 -3.4 CD 24.5 TL 42.5 | 2 - 1.0 1 - 2.0 | \emptyset 18.000 TL 56.00 | | | GASOLINE APPLICATION TEIKIN NO. | 1 |
|  | TEIKIN NO. 30115 | TEIKIN NO. P 30104 | | | | | |
| Surface Treatment Bore Clearance Tin Coated MRC: 0.030 mm Moly Skirt MP: 8.00 mm Anodized Crown | REFERENCE NO. SUB0678 | | | | | | |
| | | | | | | | |
| CHEVROLET SONIC 1.6L 1600 cc 4 cyl. | \emptyset 79.00 +1.2 CD 26.8 TL 50.0 | 2 - 1.2 1 - 2.0 | \emptyset 19.000 TL 47.00 | | | GASOLINE APPLICATION TEIKIN NO. | 2 |
|  | TEIKIN NO. 30119 | TEIKIN NO. P 44609 | | | | | |
| Surface Treatment Bore Clearance Anodized Crown MRC: 0.030 mm Moly Skirt MP: 9.00 mm 1st Ring Anodized | REFERENCE NO. 25190255 | | | | | | |
| | | | | | | | |
| CHEVROLET TRACKER 1.8 L 1796 cc 4 cyl. | \emptyset 80.50 +0.7 CD 25.4 TL 45.1 | 2 - 1.2 1 - 2.0 | \emptyset 19.000 TL 50.00 | | | GASOLINE APPLICATION TEIKIN NO. | 3 |
|  | TEIKIN NO. 30120 | TEIKIN NO. P 48205 | | | | | |
| Surface Treatment Bore Clearance Anodized Crown MRC: 0.030 mm Moly skirt MP: 7.00 mm 1st Ring Anodized | REFERENCE NO. 25192330 | | | | | | |
| | | | | | | | |
| CHEVROLET CAPTIVA 3.6 L 6 cyl. | \emptyset 87.50 -6.1 CD 27.0 TL 50.1 | 1 - 1.2 1 - 1.5 1 - 2.5 | \emptyset 21.000 TL 61.50 | | | GASOLINE APPLICATION TEIKIN NO. | 4 |
|  | TEIKIN NO. 30111-6 | TEIKIN NO. P 56104 | | | | | |
| Surface Treatment Bore Clearance Tin Coated MRC: 0.030 mm Moly Skirt MP: 10.00 mm | REFERENCE NO. 92067744 | | | | | | |
| | | | | | | | |

ADDENDUM TO TEIKIN CATALOG VOL.18 DATED SEPTEMBER 08, 2017

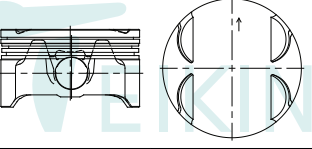
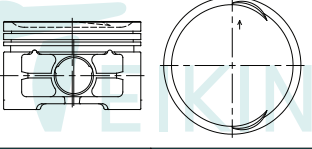
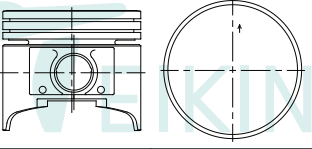
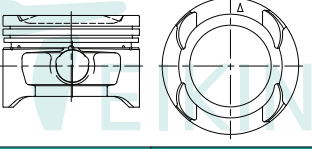
| ENGINE TYPE | PISTON | PISTON RING | PISTON PIN | PIN BUSHING | LINER | | LINER KIT SET |
|--|--------------------------------------|--|--|--|---------|------------|---------------|
| | | | | | FLANGED | NO FLANGE | |
| CHEVROLET CAPTIVA SPORT 2.4L 2384 cc 4 cyl. | Ø 88.00 CD 27.8 TL 49.3 | 1 - 1.2 1 - 1.5 1 - 2.0 | Ø 20.000 TL 55.00  | | | | 5 |
|  | | TEIKIN NO. | TEIKIN NO. | GASOLINE APPLICATION | | TEIKIN NO. | |
| Surface Treatment Anodized Crown Moly Skirt 1st Ring Anodized | | Bore Clearance MRC: 0.030 mm MP: 8.50 mm | | REFERENCE NO. 12646457 | | | |
| CHRYSLER 2.5L-II (153) SOHC 8 VAL VIN J.K SHADOW SPIRIT PHANTOM 86-95 | Ø 87.50 CD 34.5 TL 56.1 | 2 - 1.5 1 - 4.0 | Ø 22.885 TL 67.50 | | | | 6 |
|  | | TEIKIN NO. | TEIKIN NO. | GASOLINE APPLICATION | | TEIKIN NO. | |
| Surface Treatment Tin Coated | | Bore Clearance MRC: 0.030 mm MP: 6.00 mm | | REFERENCE NO. 4536292 4536293 | | | |
| CHRYSLER 3.9L (239) OHV 12 VAL DAKOTA RAM VAN RAM1500 92-03 | Ø 99.31 CD 44.8 TL 86.3 | 2 - 2.0 1 - 4.0 | Ø 25.000 TL 76.00 | | | | 7 |
|  | | TEIKIN NO. | TEIKIN NO. | GASOLINE APPLICATION | | TEIKIN NO. | |
| Surface Treatment Tin Coated | | Bore Clearance MRC: 0.030 mm MP: 24.00 mm | | REFERENCE NO. 53008567 | | | |
| DAEWOO NUBIRA-IV 4 cyl. | Ø 76.50 CD 28.3 TL 51.3 | 2 - 1.5 1 - 3.0 | Ø 18.000 TL 54.00 | | | | 8 |
|  | | TEIKIN NO. | TEIKIN NO. | GASOLINE APPLICATION | | TEIKIN NO. | |
| Surface Treatment Tin Coated | | Bore Clearance MRC: 0.030 mm MP: 9.00 mm | | REFERENCE NO. | | | |

ADDENDUM TO TEIKIN CATALOG VOL.18 DATED SEPTEMBER 08, 2017

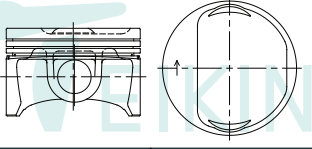
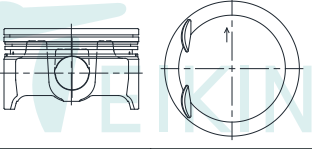
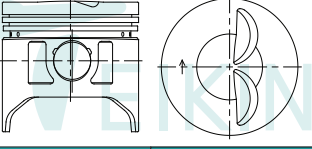
| ENGINE TYPE | PISTON | PISTON RING | PISTON PIN | PIN BUSHING | LINER | | LINER KIT SET |
|---|--|--|--------------------------------|-------------|---------|-----------|---|
| | | | | | FLANGED | NO FLANGE | |
| DAIHATSU K3-VE-III 1297 cc COPEL ~ SIRION M300/ 301/ 311 (04-06) DOHC 16V 4 cyl. | \emptyset 72.00 -4.0 CD 28.1 TL 45.2 | 2 - 1.2 1 - 2.0 | \emptyset 18.000 TL 54.00 | | | | GASOLINE APPLICATION TEIKIN NO. |
|  | | TEIKIN NO. 32607 | TEIKIN NO. P 58107 | | | | |
| Surface Treatment Bore Clearance Tin Coated MRC: 0.030 mm Anodized Crown MP: 7.00 mm | | REFERENCE NO. 13101-97401 13103-97401 | | | | | 9 |
| FIAT 1.4L 8V EVO LF 4 cyl. | \emptyset 72.00 -3.0 CD 26.0 TL 47.0 | 2 - 1.0 1 - 1.5 | \emptyset 17.973 TL 49.00 | | | | GASOLINE APPLICATION TEIKIN NO. |
|  | | TEIKIN NO. 34133 | TEIKIN NO. P 34125 | | | | |
| Surface Treatment Bore Clearance Moly Skirt MRC: 0.030 mm MP: 10.50 mm | | REFERENCE NO. MAHLE : E25930 | | | | | 10 |
| FIAT 1.6L MOTOR E-TORQUE 4 cyl. | \emptyset 77.00 -0.8 CD 25.4 TL 46.0 | 2 - 1.2 1 - 2.5 | \emptyset 19.000 TL 56.00 | | | | GASOLINE APPLICATION TEIKIN NO. |
|  | | TEIKIN NO. 34132 | TEIKIN NO. P 38145 | | | | |
| Surface Treatment Bore Clearance Anodized Crown MRC: 0.030 mm Moly Skirt MP: 9.50 mm 1st Ring Anodized | | REFERENCE NO. MAHLE : E25327 | | | | | 11 |
| FIAT 128-II 4 cyl. | \emptyset 80.00 +0.6 CD 34.7 TL 77.3 | 1 - 1.5 1 - 2.0 1 - 3.95 | \emptyset 21.982 TL 71.00 | | | | GASOLINE APPLICATION TEIKIN NO. |
|  | | TEIKIN NO. 34136 | TEIKIN NO. P 34136 | | | | |
| Surface Treatment Bore Clearance Moly Skirt MRC: 0.030 mm MP: 24.50 mm | | REFERENCE NO. | | | | | 12 |

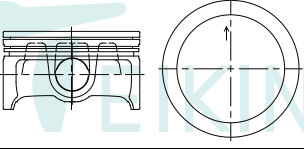
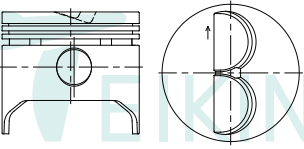
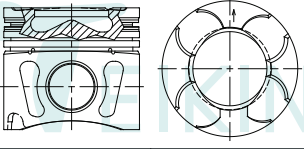
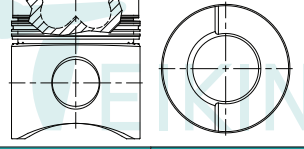

ADDENDUM TO TEIKIN CATALOG VOL.18 DATED SEPTEMBER 08, 2017

| ENGINE TYPE | PISTON | PISTON RING | PISTON PIN | PIN BUSHING | LINER | | LINER KIT SET |
|---|---|--|--------------------------------|------------------------------|--------------------------------|-----------|--|
| | | | | | FLANGED | NO FLANGE | |
| FIAT 1.8L 16V MOTOR E-TORQUE 4 cyl. | \emptyset 80.50 -0.5 CD 25.4 TL 45.9 | 2 - 1.2 1 - 2.5 | \emptyset 19.000 TL 56.00 | | | | GASOLINE APPLICATION TEIKIN NO. |
|  | TEIKIN NO. 34134 | | TEIKIN NO. P 38145 | | | | |
| Surface Treatment Anodized Crown Moly Skirt 1st Ring Anodized | Bore Clearance MRC: 0.030 mm MP: 9.50 mm | | | | | | 13 |
| | REFERENCE NO. MAHLE : E25298 | | | | | | |
| FIAT REGATA 100S 4 cyl. | \emptyset 86.40 -6.9 CD 34.7 TL 76.7 | 1 - 1.5 1 - 2.0 1 - 4.0 | \emptyset 22.000 TL 69.50 | | | | GASOLINE APPLICATION TEIKIN NO. |
|  | TEIKIN NO. 34135 | | TEIKIN NO. P 46202 | | | | |
| Surface Treatment Moly Skirt | Bore Clearance MRC: 0.030 mm MP: 25.50 mm | | | | | | 14 |
| | REFERENCE NO. | | | | | | |
| FIAT PALIO 1.3L JTD SWIFT DIESEL 3 cyl. | \emptyset 69.60 -12.4 CD 40.4 TL 62.4 | 1 - 2.0 1 - 1.5 1 - 2.0 | \emptyset 23.000 TL 56.00 | | | | DIESEL APPLICATION TEIKIN NO. LKSF 34129A |
|  | TEIKIN NO. 34129A-3 | TEIKIN NO. R 34129 | TEIKIN NO. P 34129 | TEIKIN NO. B 34129 | TEIKIN NO. LSF 34129 | | |
| Surface Treatment Moly Skirt | Bore Clearance MRC: 0.030 mm MP: 6.60 mm | | | | | | 15 |
| | REFERENCE NO. 12111-83KAO 12110M86J00-0A0 | REFERENCE NO. 12140-63E60 12140M86810 | | REFERENCE NO. | REFERENCE NO. | | |
| FIAT 115 4 cyl. | \emptyset 115.00 -27.7 CD 76.5 TL 126.5 | 1 - 3.0 FK 1 - 2.5 1 - 4.0 | \emptyset 42.000 TL 97.00 | | | | DIESEL APPLICATION TEIKIN NO. |
|  | TEIKIN NO. 34137A | | TEIKIN NO. P 34137 | | | | |
| Surface Treatment None | Bore Clearance MRC: 0.160 mm MP: 21.50 mm | | | | | | 16 |
| | REFERENCE NO. 98412636 | | | | | | |

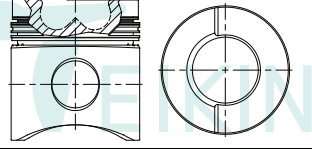
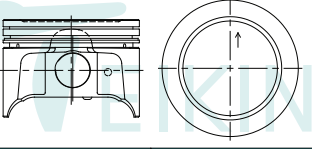
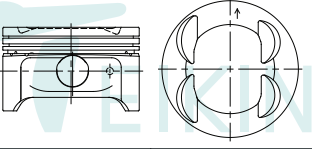
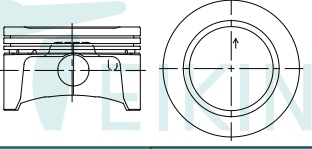



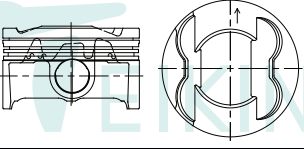
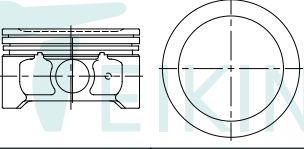
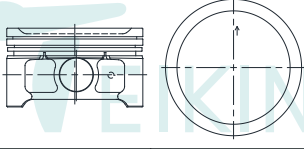

ADDENDUM TO TEIKIN CATALOG VOL.18 DATED SEPTEMBER 08, 2017

| ENGINE TYPE | PISTON | PISTON RING | PISTON PIN | PIN BUSHING | LINER | | LINER KIT SET |
|---|--|--|--|-------------|-----------------------------|-----------|-------------------|
| | | | | | FLANGED | NO FLANGE | |
| FIAT 115 6 cyl. | Ø 115.00 -27.7 CD 76.5 TL 126.5 | 1 - 3.0 FK 1 - 2.5 1 - 4.0 | Ø 42.000 TL 97.00  | | DIESEL APPLICATION | | TEIKIN NO. |
|  | TEIKIN NO. 34137A-6 | TEIKIN NO. P 34137 | | | | | 17 |
| Surface Treatment None | Bore Clearance MRC: 0.160 mm MP: 21.50 mm | REFERENCE NO. 98412636 | | | | | |
| FORD 1.4 DURATEC FIESTA 2010 - 2016 4 cyl. | Ø 76.00 -1.2 CD 28.3 TL 54.3 | 1 - 1.2 1 - 1.5 1 - 2.5 | Ø 19.000 TL 47.00 | | GASOLINE APPLICATION | | TEIKIN NO. |
|  | TEIKIN NO. 35199 | TEIKIN NO. P 44609 | | | | | 18 |
| Surface Treatment Tin Coated Moly Skirt | Bore Clearance MRC: 0.030 mm MP: 13.50 mm | REFERENCE NO. 6S6G 6100B9D | | | | | |
| FORD 1.6 NF 16V SIGMA CON ASIENTO DE VAL VUL 4 cyl. | Ø 79.00 -0.7 CD 25.3 TL 48.3 | 1 - 1.2 1 - 1.5 1 - 2.0 | Ø 18.000 TL 54.00 | | GASOLINE APPLICATION | | TEIKIN NO. |
|  | TEIKIN NO. 35196 | TEIKIN NO. P 58107 | | | | | 19 |
| Surface Treatment Tin Coated Moly Skirt | Bore Clearance MRC: 0.030 mm MP: 9.50 mm | REFERENCE NO. 4M5G-6105EC 4M5G-6105ED | | | | | |
| FORD 1.6 NF-II 16V SIGMA 4 cyl. | Ø 79.00 -0.7 CD 25.1 TL 48.1 | 1 - 1.2 1 - 1.5 1 - 2.0 | Ø 18.000 TL 50.00 | | GASOLINE APPLICATION | | TEIKIN NO. |
|  | TEIKIN NO. 35197 | TEIKIN NO. P 45136 | | | | | 20 |
| Surface Treatment Tin Coated Moly Skirt | Bore Clearance MRC: 0.030 mm MP: 11.00 mm | REFERENCE NO. | | | | | |

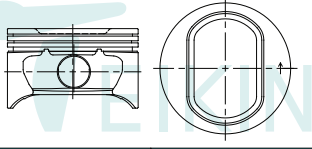

ADDENDUM TO TEIKIN CATALOG VOL.18 DATED SEPTEMBER 08, 2017

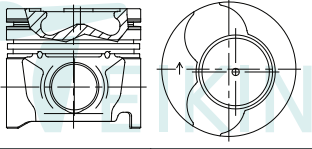
| ENGINE TYPE | PISTON | PISTON RING | PISTON PIN | PIN BUSHING | LINER | | LINER KIT SET |
|---|--|---|--------------------------------|--------------------------------------|---------|-----------|---|
| | | | | | FLANGED | NO FLANGE | |
| FORD 1.6 DURATEC TI-VCT 1596 cc FIESTA 2010 - NOW 4 cyl. | \emptyset 79.00 +1.2 CD 27.6 TL 47.8 | 1 - 1.2 1 - 1.5 1 - 2.0 | \emptyset 19.000 TL 56.00 | | | | GASOLINE APPLICATION TEIKIN NO. |
|  | | TEIKIN NO. 35200 | TEIKIN NO. P 38145 | | | | 21 |
| Surface Treatment Anodized Crown Moly Skirt 1st Ring Anodized | | Bore Clearance MRC: 0.030 mm MP: 5.00 mm | | REFERENCE NO. 4M5G 6100BB | | | |
| FORD 5.4L (330) 5400 cc V8, SOHC 145, V10, F450 8 cyl. | \emptyset 90.20 -1.7 CD 31.0 TL 52.0 | 2 - 1.5 1 - 3.0 | \emptyset 22.000 TL 62.00 | | | | GASOLINE APPLICATION TEIKIN NO. |
|  | | TEIKIN NO. 35190 | TEIKIN NO. P 43222 | | | | 22 |
| Surface Treatment Chromated Moly Skirt | | Bore Clearance MRC: 0.030 mm MP: 7.00 mm | | REFERENCE NO. XL3Z-6108-CA | | | |
| FORD E SERIES 8 cyl. | \emptyset 90.20 -3.7 CD 30.8 TL 52.1 | 2 - 1.5 1 - 3.0 | \emptyset 22.000 TL 62.00 | | | | GASOLINE APPLICATION TEIKIN NO. |
|  | | TEIKIN NO. 35192 | TEIKIN NO. P 43222 | | | | 23 |
| Surface Treatment Moly Skirt | | Bore Clearance MRC: 0.030 mm MP: 7.50 mm | | REFERENCE NO. XL3Z6148KA | | | |
| FORD E SERIES-II 8 cyl. | \emptyset 90.20 -1.8 CD 31.0 TL 52.0 | 2 - 1.5 1 - 3.0 | \emptyset 22.000 TL 62.00 | | | | GASOLINE APPLICATION TEIKIN NO. |
|  | | TEIKIN NO. 35193 | TEIKIN NO. P 43222 | | | | 24 |
| Surface Treatment Moly Skirt | | Bore Clearance MRC: 0.030 mm MP: 7.50 mm | | REFERENCE NO. XC3Z6108CA | | | |

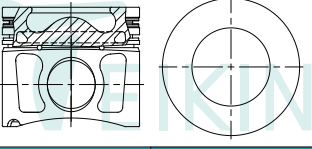



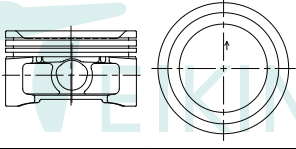
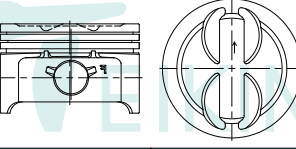
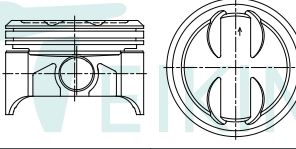
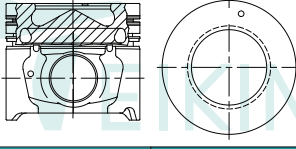



ADDENDUM TO TEIKIN CATALOG VOL.18 DATED SEPTEMBER 08, 2017

| ENGINE TYPE | PISTON | PISTON RING | PISTON PIN | PIN BUSHING | LINER | | LINER KIT SET | |
|---|--|--|--|------------------------------|---|--------------------|---------------|--|
| | | | | | FLANGED | NO FLANGE | | |
| FORD TRITON 8 cyl. | Ø 90.20 CD 30.7 TL 52.0 | 2 - 1.5 1 - 3.0 | Ø 22.000 TL 62.00  | | GASOLINE APPLICATION | | TEIKIN NO. | |
|  | TEIKIN NO. 35194 | TEIKIN NO. P 43222 | | | | | 25 | |
| Surface Treatment Anodized Crown Moly Skirt 1st Ring Anodized | Bore Clearance MRC: 0.030 mm MP: 7.50 mm | REFERENCE NO. 3L 3Z 6108 CC | | | | | | |
| FORD 4.2L 6 cyl. | Ø 96.80 CD 31.9 TL 58.8 | 2 - 1.5 1 - 3.0 | Ø 23.000 TL 65.00  | | GASOLINE APPLICATION | | TEIKIN NO. | |
|  | TEIKIN NO. 35198 | TEIKIN NO. P G2104 | | | | | 26 | |
| Surface Treatment Chromated Moly Skirt | Bore Clearance MRC: 0.030 mm MP: 10.80 mm | REFERENCE NO. 5L3Z6108 AA | | | | | | |
| FORD FIESTA 4 cyl. | Ø 73.70 CD 42.9 TL 65.4 | 1 - 2.5 FK 1 - 2.0 1 - 2.5 | Ø 25.000 TL 60.00  | | DIESEL APPLICATION | | TEIKIN NO. | |
|  | TEIKIN NO. 35195A | TEIKIN NO. P 39179 | | | | | 27 | |
| Surface Treatment Moly Skirt | Bore Clearance MRC: 0.030 mm MP: 6.50 mm | REFERENCE NO. 7S6Q 6110 A9A | | | | | | |
| FORD 2.2L DURATORQ TDCI 2184 cc "PUMA" ZSD-422 2000-Present Ford Transit (2000-Present) Ford Ranger (2011-Present) 4 cyl. | Ø 86.00 CD 48.4 TL 74.8 | 2 - 2.0 1 - 2.0 | Ø 30.000 TL 66.00  | | TL 156.0 OD 89.0 FT 5.0 FD 90.9 | DIESEL APPLICATION | | TEIKIN NO. LKFF 35201AG LKSF 35201AG |
|  | TEIKIN NO. 35201AG | TEIKIN NO. R 35201 | TEIKIN NO. P 66105 | TEIKIN NO. B 35201 | TEIKIN NO. LFF 35201 LSF 35201 | | | 28 |
| Surface Treatment Chromated Moly Skirt | Bore Clearance MRC: 0.030 mm MP: 8.50 mm | REFERENCE NO. KS: 800071510000 KS: 800071540000 KS: 800075210000 MAHLE: 015 70 NO | | REFERENCE NO. | REFERENCE NO. G-1402112000 | | | |

ADDENDUM TO TEIKIN CATALOG VOL.18 DATED SEPTEMBER 08, 2017

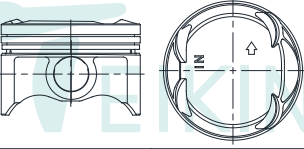
| ENGINE TYPE | PISTON | PISTON RING | PISTON PIN | PIN BUSHING | LINER | | LINER KIT SET |
|---|--|----------------------------------|--|-------------|---------|-----------|------------------------------------|
| | | | | | FLANGED | NO FLANGE | |
| GENERAL MOTORS 2.2L 4 cyl.  | Ø 89.00 -5.2 CD 30.1 TL 51.1 | 2 - 1.5 1 - 3.0 | Ø 20.320 TL 61.50 | | | | GASOLINE APPLICATION TEIKIN NO. |
| Surface Treatment Tin Coated | Bore Clearance MRC: 0.030 mm MP: 5.00 mm | TEIKIN NO. 58120 | TEIKIN NO. P 58120 | | | | 33 |
| | REFERENCE NO. 24576691 | | | | | | |
| GENERAL MOTORS 4.3L 6 cyl.  | Ø 101.60 -1.6 CD 39.4 TL 65.3 | 2 - 1.5 1 - 3.0 | Ø 23.550 TL 76.00 | | | | GASOLINE APPLICATION TEIKIN NO. |
| Surface Treatment Chromated Moly Skirt | Bore Clearance MRC: 0.030 mm MP: 11.00 mm | TEIKIN NO. 58121 | TEIKIN NO. P 58112 | | | | 34 |
| | REFERENCE NO. 88894280 12522850 | | | | | | |
| GENERAL MOTORS 5.7L (350) 8 cyl. OHV 16 VAL CAPRICE CONCOURS CHEVY NOVA 73-91  | Ø 101.60 -1.7 CD 39.1 TL 70.2 | 2 - 2.0 1 - 4.75 | Ø 23.550 TL 76.00 | | | | GASOLINE APPLICATION TEIKIN NO. |
| Surface Treatment Tin Coated | Bore Clearance MRC: 0.030 mm MP: 16.50 mm | TEIKIN NO. 58112 | TEIKIN NO. P 58112 | | | | 35 |
| | REFERENCE NO. 2774228 | | | | | | |
| GENERAL MOTORS CAPTIVA WINDSTROM 4 cyl.  | Ø 83.00 -14.0 CD 46.3 TL 72.3 | 1 - 2.0 FK 1 - 2.0 1 - 3.0 | Ø 28.000 TL 67.00  | | | | DIESEL APPLICATION TEIKIN NO. |
| Surface Treatment Moly Skirt | Bore Clearance MRC: 0.040 mm MP: 8.00 mm | TEIKIN NO. 58118AG | TEIKIN NO. P 58118 | | | | 36 |
| | REFERENCE NO. 25182669 | | | | | | |

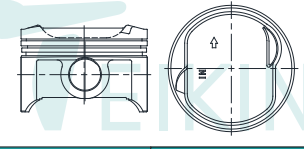

ADDENDUM TO TEIKIN CATALOG VOL.18 DATED SEPTEMBER 08, 2017

| ENGINE TYPE | PISTON | PISTON RING | PISTON PIN | PIN BUSHING | LINER | | LINER KIT SET |
|--|--|-------------------------------|--|-------------|----------------------|-----------|---------------|
| | | | | | FLANGED | NO FLANGE | |
| GEELY EMGRAND 4 cyl.  Surface Treatment: Anodized Crown, Moly Skirt, 1st Ring Anodized Bore Clearance: MRC: 0.030 mm, MP: 8.00 mm | Ø 77.80 +2.1 CD 30.1 TL 52.5 | 2 - 1.2 1 - 3.0 | Ø 20.000 TL 49.00  | | GASOLINE APPLICATION | | TEIKIN NO. |
| | TEIKIN NO. | | TEIKIN NO. | | | | |
| | REFERENCE NO. | | | | | | |
| | | | | | | | 37 |
| HONDA EB5 1433 cc 4 cyl. 145 COUPLE SOHC 8V  Surface Treatment: None Bore Clearance: MRC: 0.030 mm, MP: 18.00 mm | Ø 72.00 -1.5 CD 27.0 TL 60.0 | 2 - 1.5 1 - 2.8 | Ø 17.000 TL 62.00  | | GASOLINE APPLICATION | | TEIKIN NO. |
| | TEIKIN NO. | | TEIKIN NO. | | | | |
| | REFERENCE NO. | | | | | | |
| | | | | | | | 38 |
| HONDA L13A 4 cyl.  Surface Treatment: Moly Skirt Bore Clearance: MRC: 0.030 mm, MP: 10.00 mm | Ø 73.00 +2.4 CD 26.3 TL 50.2 | 2 - 1.0 1 - 2.0 | Ø 18.000 TL 53.00  | | GASOLINE APPLICATION | | TEIKIN NO. |
| | TEIKIN NO. | | TEIKIN NO. | | | | |
| | REFERENCE NO. | | | | | | |
| | | | | | | | 39 |
| HONDA L15A2 4 cyl. Honda City 2004  Surface Treatment: Moly Skirt Bore Clearance: MRC: 0.030 mm, MP: 10.00 mm | Ø 73.00 +2.4 CD 26.2 TL 50.1 | 1 - 1.0 1 - 1.2 1 - 2.0 | Ø 18.000 TL 53.00  | | GASOLINE APPLICATION | | TEIKIN NO. |
| | TEIKIN NO. | | TEIKIN NO. | | | | |
| | REFERENCE NO. | | | | | | |
| | | | | | | | 40 |

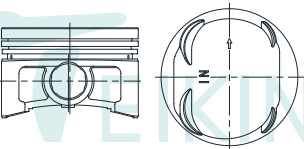
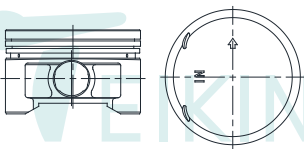
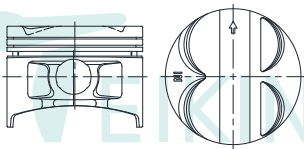
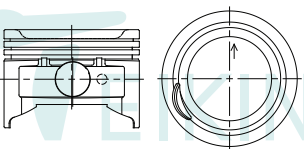

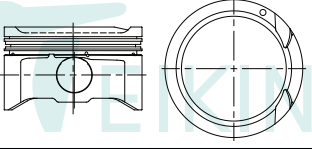
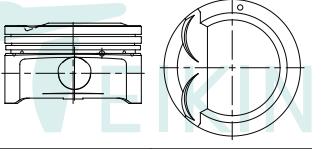

ADDENDUM TO TEIKIN CATALOG VOL.18 DATED SEPTEMBER 08, 2017

| ENGINE TYPE | PISTON | PISTON RING | PISTON PIN | PIN BUSHING | LINER | | LINER KIT SET |
|--|--|-------------------------------|-----------------------------|-------------|---|------------|---------------|
| | | | | | FLANGED | NO FLANGE | |
| HONDA D16Y8-II | Ø 75.00 -3.0 CD 29.2 TL 49.3 | 1 - 1.2 1 - 1.5 1 - 2.8 | Ø 19.000 TL 56.00 | | GASOLINE APPLICATION | | TEIKIN NO. |
| 4 cyl. | | | | | | | |
|  | | | | | TEIKIN NO. | TEIKIN NO. | |
| Surface Treatment Bore Clearance None MRC: 0.030 mm MP: 7.00 mm | | | | | REFERENCE NO. 13010-P2M-Y00 | | |
| 41 | | | | | | | |
| HONDA D17A | Ø 75.00 -3.0 CD 27.0 TL 46.6 | 1 - 1.0 1 - 1.2 1 - 2.8 | Ø 19.000 TL 56.00 | | GASOLINE APPLICATION | | TEIKIN NO. |
| 4 cyl. | | | | | | | |
|  | | | | | TEIKIN NO. | TEIKIN NO. | |
| Surface Treatment Bore Clearance Tin Coated MRC: 0.030 mm MP: 7.30 mm | | | | | REFERENCE NO. 13010-PLR-Y00 | | |
| 42 | | | | | | | |
| HONDA B18C1-II | Ø 81.00 -3.3 CD 30.1 TL 60.1 | 1 - 1.0 1 - 1.2 1 - 2.8 | Ø 21.000 TL 56.50 | | GASOLINE APPLICATION | | TEIKIN NO. |
| 1797 cc 4 cyl. | | | | | | | |
|  | | | | | TEIKIN NO. | TEIKIN NO. | |
| Surface Treatment Bore Clearance None MRC: 0.030 mm MP: 14.00 mm | | | | | REFERENCE NO. 13010-P72-A00 13020-P72-A00 | | |
| 43 | | | | | | | |
| HYUNDAI SANTRO XING ERLX 1.1L | Ø 67.00 -4.4 CD 24.5 TL 48.5 | 2 - 1.2 1 - 2.0 | Ø 17.000 TL 46.50 | | GASOLINE APPLICATION | | TEIKIN NO. |
| 4 cyl. | | | | | | | |
|  | | | | | TEIKIN NO. | TEIKIN NO. | |
| Surface Treatment Bore Clearance None MRC: 0.030 mm MP: 13.00 mm | | | | | REFERENCE NO. 51152 P 51117 | | |
| 44 | | | | | | | |

ADDENDUM TO TEIKIN CATALOG VOL.18 DATED SEPTEMBER 08, 2017

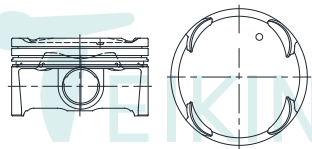
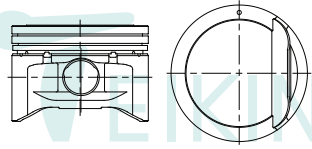
| ENGINE TYPE | PISTON | PISTON RING | PISTON PIN | PIN BUSHING | LINER | | LINER KIT SET |
|--|---|-------------------------------|--|-------------|---------|-----------|------------------------------------|
| | | | | | FLANGED | NO FLANGE | |
| HYUNDAI G4LA 1248 cc GETZ ~ I10 ~ I20 (08-10) DOHC 16V  | ∅ 71.00 -3.0 CD 24.7 TL 42.7 | 1 - 1.0 1 - 1.2 1 - 2.0 | ∅ 18.000 TL 48.00 | | | | GASOLINE APPLICATION TEIKIN NO. |
| Surface Treatment Tin Coated Moly Skirt | Bore Clearance MRC: 0.030 mm MP: 6.50 mm | TEIKIN NO. 51612 | TEIKIN NO. P 46683 | | | | 45 |
| | REFERENCE NO. 23041-03200 23041-03210 23041-03220 | | | | | | |
| HYUNDAI ACCENT 1.4 4 cyl. | ∅ 72.00 -3.6 CD 24.7 TL 42.7 | 1 - 1.0 1 - 1.2 1 - 2.0 | ∅ 18.000 TL 47.50 | | | | GASOLINE APPLICATION TEIKIN NO. |
| Surface Treatment Tin Coated Moly Skirt | Bore Clearance MRC: 0.030 mm MP: 6.00 mm | TEIKIN NO. 51153 | TEIKIN NO. P 30110 | | | | 46 |
| | REFERENCE NO. 23041 03AA0 | | | | | | |
| HYUNDAI G4FA 1394 cc ACCENT ~GETZ I20 ~I30 ~I3cw A2 ~ CEED ~IH (09-) DOHC 16V  | ∅ 77.00 +1.4 CD 26.9 TL 45.3 | 2 - 1.2 1 - 2.0 | ∅ 18.000 TL 53.00 | | | | GASOLINE APPLICATION TEIKIN NO. |
| Surface Treatment Tin Coated Moly Skirt | Bore Clearance MRC: 0.030 mm MP: 5.00 mm | TEIKIN NO. 51149 | TEIKIN NO. P 46332 | | | | 47 |
| | REFERENCE NO. 23041-2B101 23041-2B111 23041-2B121 | | | | | | |
| HYUNDAI ELANTRA 4 cyl. | ∅ 81.00 -1.0 CD 28.5 TL 46.0 | 1 - 1.0 1 - 1.2 1 - 2.0 | ∅ 20.000 TL 49.00  | | | | GASOLINE APPLICATION TEIKIN NO. |
| Surface Treatment Anodized Crown Moly Skirt 1st Ring Anodized | Bore Clearance MRC: 0.030 mm MP: 6.00 mm | TEIKIN NO. 51146 | TEIKIN NO. P 51146 | | | | 48 |
| | REFERENCE NO. 23041 2E100 | | | | | | |

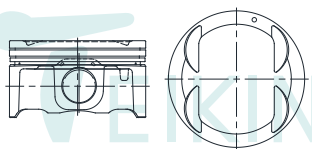

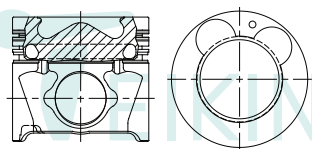

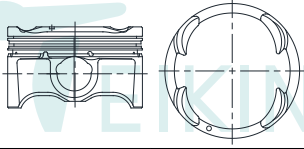
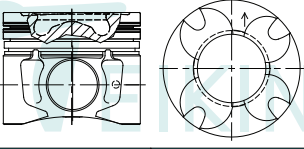
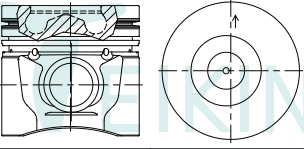
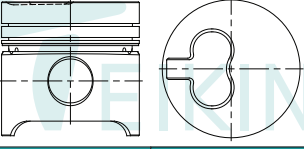

ADDENDUM TO TEIKIN CATALOG VOL.18 DATED SEPTEMBER 08, 2017

| ENGINE TYPE | PISTON | PISTON RING | PISTON PIN | PIN BUSHING | LINER | | LINER KIT SET |
|---|---|-------------------------------------|---|----------------------|----------------------|-----------|--|
| | | | | | FLANGED | NO FLANGE | |
| HYUNDAI NU 2.0L 4 cyl. | \emptyset 81.00 -2.6 CD 28.5 TL 46.0 | 1 - 1.0 1 - 1.2 1 - 2.0 | \emptyset 20.000 TL 49.00  | | GASOLINE APPLICATION | | TEIKIN NO. <div style="text-align: right; background-color: #008080; color: white; padding: 5px; font-weight: bold;">49</div> |
|  | TEIKIN NO. | | TEIKIN NO. | | | | |
| Surface Treatment Anodized Crown Moly Skirt 1st Ring Anodized | Bore Clearance MRC: 0.030 mm MP: 6.00 mm | | | | | | |
| REFERENCE NO. 23041-2E000 | | | | | | | |
| HYUNDAI G4GC 2.0L EFI DOHC 16v 4 cyl. | \emptyset 82.00 +0.3 CD 31.0 TL 57.8 | 2 - 1.2 1 - 2.0 | \emptyset 20.000 TL 59.00 | | GASOLINE APPLICATION | | TEIKIN NO. <div style="text-align: right; background-color: #008080; color: white; padding: 5px; font-weight: bold;">50</div> |
|  | TEIKIN NO. | | TEIKIN NO. | | | | |
| Surface Treatment Tin Coated Moly Skirt | Bore Clearance MRC: 0.030 mm MP: 10.00 mm | | | | | | |
| REFERENCE NO. 23410-23AA1 | | | | | | | |
| HYUNDAI G6DB-II 6 cyl. | \emptyset 92.00 -0.7 CD 30.7 TL 51.8 | 2 - 1.2 1 - 2.0 | \emptyset 22.000 TL 58.00  | | GASOLINE APPLICATION | | TEIKIN NO. <div style="text-align: right; background-color: #008080; color: white; padding: 5px; font-weight: bold;">51</div> |
|  | TEIKIN NO. | | TEIKIN NO. | | | | |
| Surface Treatment Tin Coated Moly Skirt | Bore Clearance MRC: 0.030 mm MP: 7.50 mm | | | | | | |
| REFERENCE NO. 23041-3C502 | | | | | | | |
| HYUNDAI D4FA 1493 cc GETZ MATRIX 1.5 CRDI 4 cyl. | \emptyset 75.00 -12.3 CD 42.0 TL 65.8 | 2 - 1.75 1 - 3.0 | \emptyset 28.000 TL 62.00  | | DIESEL APPLICATION | | TEIKIN NO. LKSF 51150AG LKSX 51150AG <div style="text-align: right; background-color: #008080; color: white; padding: 5px; font-weight: bold;">52</div> |
|  | TEIKIN NO. | TEIKIN NO. | TEIKIN NO. | TEIKIN NO. | TEIKIN NO. | | |
| Surface Treatment Moly Skirt | Bore Clearance MRC: 0.030 mm MP: 7.50 mm | | | | | | |
| REFERENCE NO. 23410-2A901 23410-2A911 23410-2A921 23410-2A931 23410-2A941 | REFERENCE NO. 23040-2A900 23040-2A901 23040-2A902 | REFERENCE NO. 23517-2A600 | REFERENCE NO. LSF 51142 LSX 51142 | REFERENCE NO. | | | |

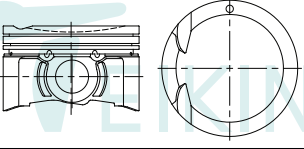
ADDENDUM TO TEIKIN CATALOG VOL.18 DATED SEPTEMBER 08, 2017

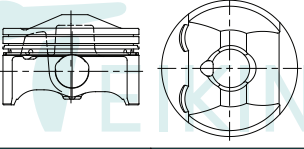
| ENGINE TYPE | PISTON | PISTON RING | PISTON PIN | PIN BUSHING | LINER | | LINER KIT SET |
|---|---|--------------------------------------|--------------------------------|-------------|----------------------|-----------|---------------|
| | | | | | FLANGED | NO FLANGE | |
| KIA ION 4 cyl. | \emptyset 71.00 -3.2 CD 24.7 TL 42.7 | 1 - 1.0 1 - 1.2 1 - 2.0 | \emptyset 18.000 TL 47.50 | | GASOLINE APPLICATION | | TEIKIN NO. |
|  | | TEIKIN NO. | TEIKIN NO. | | | | 57 |
| Surface Treatment Tin Coated Moly Skirt Bore Clearance MRC: 0.030 mm MP: 7.50 mm | | 52114-4 | P 30110 | | | | |
| | | REFERENCE NO. | | | | | |
| | | REFERENCE NO. 23041-04000 | | | | | |
| MAHINDRA MAXIMO 2 cyl. | \emptyset 83.00 -14 CD 43.8 TL 67.8 | 1 - 2.0 FK 1 - 1.5 1 - 2.0 | \emptyset 30.000 TL 66.00 | | DIESEL APPLICATION | | TEIKIN NO. |
|  | | TEIKIN NO. | TEIKIN NO. | | | | 58 |
| Surface Treatment Chromated Moly Skirt Bore Clearance MRC: 0.060 mm MP: 6.00 mm | | 66105A | P 66105 | | | | |
| | | REFERENCE NO. | | | | | |
| | | REFERENCE NO. | | | | | |
| MAHINDRA MDI 3200 4 cyl. | \emptyset 88.90 -18.4 CD 51.3 TL 84.3 | 1 - 3.0 FK 1 - 2.5 1 - 4.0 | \emptyset 28.000 TL 67.00 | | DIESEL APPLICATION | | TEIKIN NO. |
|  | | TEIKIN NO. | TEIKIN NO. | | | | 59 |
| Surface Treatment Chromated Bore Clearance MRC: 0.040 mm MP: 7.00 mm | | 66103A | P 58118 | | | | |
| | | REFERENCE NO. | | | | | |
| | | REFERENCE NO. | | | | | |
| MAHINDRA XD3P 4 cyl. | \emptyset 94.00 -2 CD 53.9 TL 91.3 | 2 - 2.0 1 - 4.0 | \emptyset 30.000 TL 79.80 | | DIESEL APPLICATION | | TEIKIN NO. |
|  | | TEIKIN NO. | TEIKIN NO. | | | | 60 |
| Surface Treatment Tin Coated Bore Clearance MRC: 0.100 mm MP: 15.00 mm | | 66104 | P 44296 | | | | |
| | | REFERENCE NO. | | | | | |
| | | REFERENCE NO. | | | | | |

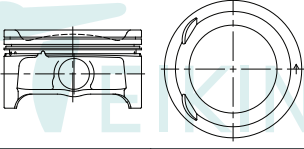
ADDENDUM TO TEIKIN CATALOG VOL.18 DATED SEPTEMBER 08, 2017

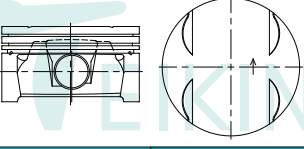
| ENGINE TYPE | PISTON | PISTON RING | PISTON PIN | PIN BUSHING | LINER | | LINER KIT SET |
|---|--|--------------------------------|---|-------------|---------|-----------|--|
| | | | | | FLANGED | NO FLANGE | |
| MAZDA ZJ 1348 cc 2 ~ 3 (03-06) DOHC 16V 4 cyl. | \emptyset 74.00 -3.3 CD 27.5 TL 46.0 | 2 - 1.2 1 - 2.5 | \emptyset 18.000 TL 59.00 | | | | GASOLINE APPLICATION TEIKIN NO. |
|  | TEIKIN NO. 42679 | | TEIKIN NO. P 46141 | | | | 61 |
| Surface Treatment None Bore Clearance MRC: 0.030 mm MP: 6.00 mm | REFERENCE NO. ZJY1-11-SAO ZJY1-11-SAOA ZJY2-11-SAOA | | | | | | |
| MAZDA SKYACTIV-G 1.5L 4 cyl. | \emptyset 74.50 +7.4 CD 23.60 TL 49.30 | 2 - 1.0 1 - 2.0 | \emptyset 18.000 TL 43.00  | | | | GASOLINE APPLICATION TEIKIN NO. |
|  | TEIKIN NO. 42224 | | TEIKIN NO. P 42224 | | | | 62 |
| Surface Treatment Anodized Crown Moly Skirt 1st Ring Anodized Bore Clearance MRC: 0.030 mm MP: 7.00 mm | REFERENCE NO. P5Y2-11-SAO | | | | | | |
| MAZDA L5-VE 2488 cc 3 ~ 6 ~ CX-7 (07-) DOHC 16V 4 cyl. | \emptyset 89.00 -6.8 CD 28.4 TL 50.6 | 2 - 1.2 1 - 2.5 | \emptyset 20.000 TL 55.00  | | | | GASOLINE APPLICATION TEIKIN NO. |
|  | TEIKIN NO. 42680 | | TEIKIN NO. P 42108 | | | | 63 |
| Surface Treatment Anodized Crown Moly Skirt 1st Ring Anodized Bore Clearance MRC: 0.030 mm MP: 10.00 mm | REFERENCE NO. L5Y3-11-SAO | | | | | | |
| MERCEDES BENZ M272 3498 cc 6 cyl. | \emptyset 92.90 -0.1 CD 30.4 TL 50.8 | 1 - 1.5 1 - 1.75 1 - 2.5 | \emptyset 22.000 TL 52.00  | | | | GASOLINE APPLICATION TEIKIN NO. |
|  | TEIKIN NO. 29605 | | TEIKIN NO. P 55106 | | | | 64 |
| Surface Treatment Anodized Crown Moly Skirt 1st Ring Anodized Bore Clearance MRC: 0.050 mm MP: 4.00 mm | REFERENCE NO. 272 030 22 17 272 030 43 17 272 030 89 17 272 030 97 17 | | | | | | |



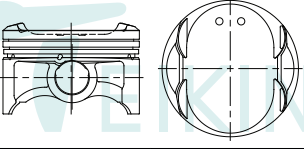
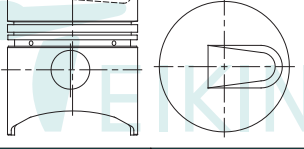
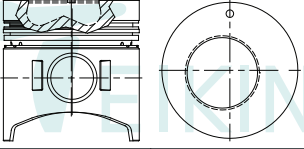
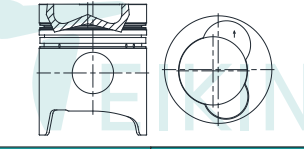

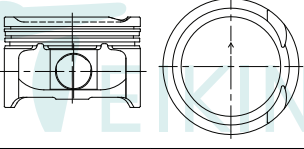
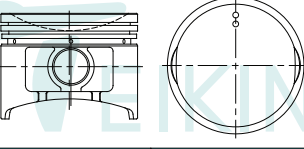
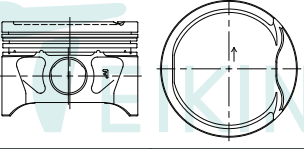
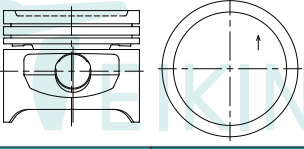

ADDENDUM TO TEIKIN CATALOG VOL.18 DATED SEPTEMBER 08, 2017

| ENGINE TYPE | PISTON | PISTON RING | PISTON PIN | PIN BUSHING | LINER | | LINER KIT SET |
|---|---|----------------------------------|------------------------------|---------------|-------------------------------------|---|---|
| | | | | | FLANGED | NO FLANGE | |
| mitsubishi 4A92 1598 cc 4 cyl. | Ø 75.00 +3.9 CD 26.0 TL 49.9 | 1 - 1.0 1 - 1.2 1 - 2.0 | Ø 18.000 TL 50.00 | | | | GASOLINE APPLICATION TEIKIN NO. |
|  | TEIKIN NO. | | TEIKIN NO. | | | | 65 |
| | 43296-4 | | P 45136 | | | | |
| | REFERENCE NO. | | REFERENCE NO. | | | | |
| Surface Treatment Bore Clearance Moly Skirt Anodized Crown 1st Ring Anodized | MRC: 0.030 mm MP: 8.50 mm | | | | | | |
| mitsubishi S6E 2610 cc 6 cyl. | Ø 94.00 -3.5 CD 51.5 TL 98.5 | 1 - 2.5 HK 1 - 2.0 1 - 4.5 | Ø 28.000 TL 77.00 | | TL OD FT FD | 165.0 98.0 | DIESEL APPLICATION TEIKIN NO. LKXS 43655-6 |
|  | TEIKIN NO. | TEIKIN NO. | TEIKIN NO. | TEIKIN NO. | TEIKIN NO. | | 66 |
| | 43655-6 | R 43655 | P 43609 | B 43157 | LSX 43655 | | |
| | REFERENCE NO. | REFERENCE NO. | REFERENCE NO. | REFERENCE NO. | REFERENCE NO. | | |
| Surface Treatment Bore Clearance Tin Coated | MRC: 0.170 mm MP: 13.00 mm | | | | | | |
| mitsubishi 4D33-III 4 cyl. | Ø 108.00 -20.5 CD 62.1 TL 112.1 | 1 - 3.0 1 - 2.0 1 - 4.0 | Ø 34.000 TL 83.50 | | TL OD FT FD | 205.0 112.0 5.0 200.0 112.0 | DIESEL APPLICATION TEIKIN NO. LKSF 43244 LKFX 43244 LKXS 43244 |
|  | TEIKIN NO. | TEIKIN NO. | TEIKIN NO. | TEIKIN NO. | TEIKIN NO. | | 67 |
| | 43299A | R 43244 | P 39138 | B 43170 | LSF 43244 LFX 43244 LSX 43244 | | |
| | REFERENCE NO. | REFERENCE NO. | REFERENCE NO. | REFERENCE NO. | REFERENCE NO. | | |
| Surface Treatment Bore Clearance Tin Coated | MRC: 0.080 mm MP: 26.50 mm | | | | | | |
| mitsubishi 6D22-T-II 11149 cc 6 cyl. | Ø 130.00 -23.3 CD 83.1 TL 158.2 | 1 - 3.5 FK 1 - 3.0 1 - 6.0 | Ø 50.000 TL 105.00 | | TL OD FT FD | 262.0 147.0 11.5 + 1.8 156.0 | DIESEL APPLICATION TEIKIN NO. LKFF 43699A |
|  | TEIKIN NO. | TEIKIN NO. | TEIKIN NO. | TEIKIN NO. | TEIKIN NO. | | 68 |
| | 43699A | R 43614 | P 39624 | B 43614 | LFF 43614 | | |
| | REFERENCE NO. | REFERENCE NO. | REFERENCE NO. | REFERENCE NO. | REFERENCE NO. | | |
| Surface Treatment Bore Clearance Tin Coated | MRC: 0.190 mm MP: 39.50 mm | | | | | | |

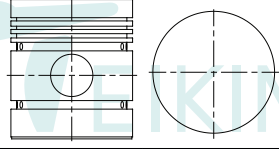
ADDENDUM TO TEIKIN CATALOG VOL.18 DATED SEPTEMBER 08, 2017

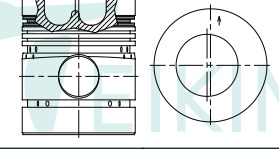
| ENGINE TYPE | PISTON | PISTON RING | PISTON PIN | PIN BUSHING | LINER | | LINER KIT SET |
|---|--|--|--------------------------------|-------------|---------|-----------|------------------------------------|
| | | | | | FLANGED | NO FLANGE | |
| NISSAN CR12DE 997 cc MICRA K12E (05-) DOHC 16V | \emptyset 71.00 -2.6 CD 28.4 TL 47.2 | 2 - 1.2 1 - 2.0 | \emptyset 18.000 TL 48.00 | | | | GASOLINE APPLICATION TEIKIN NO. |
|  | TEIKIN NO. 44705 | | TEIKIN NO. P 46683 | | | | 69 |
| Surface Treatment Tin Coated Anodized Crown | Bore Clearance MRC: 0.030 mm MP: 8.00 mm | REFERENCE NO. 12010-BX010 12010-BX011 12010-BX012 12010-BX070 | | | | | |
| NISSAN MA 12S 1235 cc MICRA K10 (86-88) SOHC 8V | \emptyset 71.00 -9.0 CD 28.5 TL 54.7 | 2 - 1.5 1 - 2.8 | \emptyset 17.000 TL 58.00 | | | | GASOLINE APPLICATION TEIKIN NO. |
|  | TEIKIN NO. 44704 | | TEIKIN NO. P 44600 | | | | 70 |
| Surface Treatment Tin Coated | Bore Clearance MRC: 0.030 mm MP: 12.00 mm | REFERENCE NO. 12010-18B65/71/72 12010-05B01/01/02/03 12010-05B04/05/06 12010-18B02/03/61 12010-18B62/63/64 | | | | | |
| NISSAN 1.6L 1598 cc 4 cyl. | \emptyset 79.50 -1.6 CD 31.7 TL 55.0 | 1 - 1.2 1 - 1.5 1 - 2.5 | \emptyset 20.000 TL 62.00 | | | | GASOLINE APPLICATION TEIKIN NO. |
|  | TEIKIN NO. 44356 | | TEIKIN NO. P 38129 | | | | 71 |
| Surface Treatment Tin Coated | Bore Clearance MRC: 0.030 mm MP: 10.50 mm | REFERENCE NO. | | | | | |
| OPEL X 1.2 SZ 1195 cc 4 cyl. | \emptyset 72.00 -2.8 CD 32.1 TL 59.0 | 2 - 1.5 1 - 3.0 | \emptyset 18.000 TL 50.00 | | | | GASOLINE APPLICATION TEIKIN NO. |
|  | TEIKIN NO. 56607 | | TEIKIN NO. P 45136 | | | | 72 |
| Surface Treatment Tin Coated | Bore Clearance MRC: 0.020 mm MP: 9.50 mm | REFERENCE NO. | | | | | |

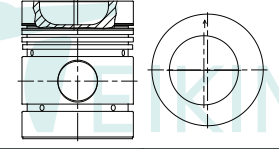

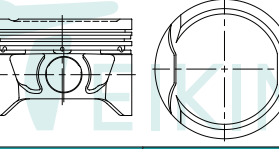

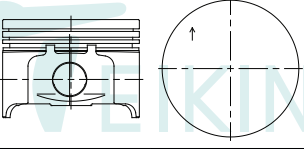
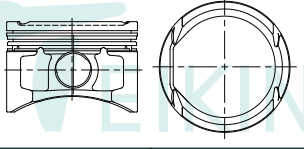
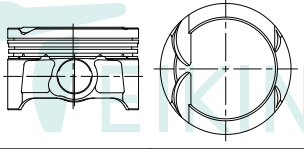
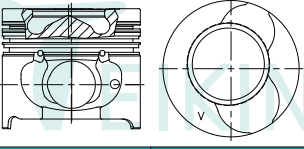

ADDENDUM TO TEIKIN CATALOG VOL.18 DATED SEPTEMBER 08, 2017

| ENGINE TYPE | PISTON | PISTON RING | PISTON PIN | PIN BUSHING | LINER | | LINER KIT SET |
|--|---------------------------------------|-------------------------------|--|-------------|----------------------|------------|---------------|
| | | | | | FLANGED | NO FLANGE | |
| PERKINS MF-5F 4 cyl. | Ø 91.48 CD 56.9 TL 104.6 | 2 - 2.4 1 - 3.2 2 - 6.4 | Ø 31.750 TL 75.00  | | DIESEL APPLICATION | | TEIKIN NO. |
|  | TEIKIN NO. | TEIKIN NO. | TEIKIN NO. | TEIKIN NO. | TEIKIN NO. | TEIKIN NO. | |
| Surface Treatment None Bore Clearance MRC: 0.140 mm MP: 20.00 mm | G8106 G8106A | P 42149 | REFERENCE NO. | | | | |
| | | | | | | | |
| PERKINS MOT 6.354-II 6 cyl. | Ø 98.43 CD 69.9 TL 120.6 | 1 - 3.2 2 - 2.4 2 - 6.4 | Ø 34.925 TL 84.00  | | DIESEL APPLICATION | | TEIKIN NO. |
| 1972-92  | TEIKIN NO. | TEIKIN NO. | TEIKIN NO. | TEIKIN NO. | TEIKIN NO. | TEIKIN NO. | |
| Surface Treatment Tin Coated Bore Clearance MRC: 0.130 mm MP: 23.00 mm | G8105A | P G8101 | REFERENCE NO. | | | | |
| | | | | | | | |
| PERKINS 26.63 4 cyl. | Ø 98.48 CD 70.6 TL 121.4 | 3 - 2.4 2 - 6.4 | Ø 34.925 TL 84.00  | | DIESEL APPLICATION | | TEIKIN NO. |
|  | TEIKIN NO. | TEIKIN NO. | TEIKIN NO. | TEIKIN NO. | TEIKIN NO. | TEIKIN NO. | |
| Surface Treatment None Bore Clearance MRC: 0.150 mm MP: 21.00 mm | G8107 G8107A | P G8101 | REFERENCE NO. | | | | |
| | | | | | | | |
| RENAULT K4M 1598 cc 700/701/704/706 708/709/710/ 712/714/720/724 745/748/752/760 4 cyl. | Ø 79.50 CD 31.7 TL 55.0 | 2 - 1.5 1 - 2.5 | Ø 20.000 TL 62.00  | | GASOLINE APPLICATION | | TEIKIN NO. |
|  | TEIKIN NO. | TEIKIN NO. | TEIKIN NO. | TEIKIN NO. | TEIKIN NO. | TEIKIN NO. | |
| Surface Treatment Tin Coated Bore Clearance MRC: 0.030 mm MP: 10.00 mm | 70600 | P 38129 | REFERENCE NO. | | | | |
| | | | | | | | |

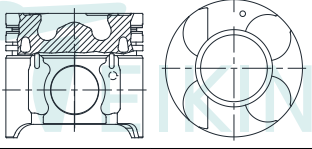

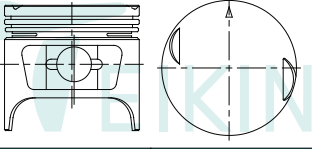

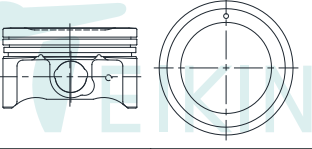

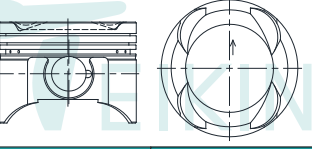
ADDENDUM TO TEIKIN CATALOG VOL.18 DATED SEPTEMBER 08, 2017

| ENGINE TYPE | PISTON | PISTON RING | PISTON PIN | PIN BUSHING | LINER | | LINER KIT SET |
|---|--|-----------------------------------|------------------------------|-------------|---------|-----------|---|
| | | | | | FLANGED | NO FLANGE | |
| RENAULT K7J 710 1000 cc 4 cyl. | Ø 79.50 CD 34.8 TL 57.0 | 2 - 1.5 1 - 2.5 | Ø 19.000 TL 62.00 | | | | GASOLINE APPLICATION TEIKIN NO. |
|  | TEIKIN NO. 70601 | | TEIKIN NO. P 44259 | | | | |
| Surface Treatment Bore Clearance Tin Coated MRC: 0.030 mm MP: 7.00 mm | REFERENCE NO. 60 01 548 037 60 01 548 038 60 01 548 039 60 01 549 028/28/30 | | | | | | 77 |
| RENAULT 2.0L 4 cyl. 16V MOTOR F4R MEGANE II | Ø 82.70 CD 30.5 TL 57.0 | 1 - 1.2 1 - 1.5 1 - 2.0 | Ø 21.000 TL 61.50 | | | | GASOLINE APPLICATION TEIKIN NO. |
|  | TEIKIN NO. 70101 | | TEIKIN NO. P 56104 | | | | |
| Surface Treatment Bore Clearance Tin Coated MRC: 0.030 mm MP: 12.00 mm | REFERENCE NO. | | | | | | 78 |
| RENAULT 2.0L-II 4 cyl. 16V MOTOR F4R DUSTER | Ø 82.70 CD 30.4 TL 52.0 | 1 - 1.2 1 - 1.5 1 - 2.0 | Ø 21.000 TL 63.50 | | | | GASOLINE APPLICATION TEIKIN NO. |
|  | TEIKIN NO. 70102 | | TEIKIN NO. P 32120 | | | | |
| Surface Treatment Bore Clearance Anodized Crown Moly Skirt 1st Ring Anodized MRC: 0.030 mm MP: 8.50 mm | REFERENCE NO. | | | | | | 79 |
| RENAULT K9K 1461 cc MAHINDRA LOGAN 4 cyl. | Ø 76.00 CD 41.8 TL 66.0 | 2 - 2.0 1 - 2.5 | Ø 26.000 TL 60.00 | | | | DIESEL APPLICATION TEIKIN NO. |
|  | TEIKIN NO. 70103A | | TEIKIN NO. P 70103 | | | | |
| Surface Treatment Bore Clearance Moly Skirt MRC: 0.030 mm MP: 8.50 mm | REFERENCE NO. 120A11819R | | | | | | 80 |

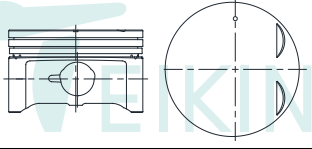

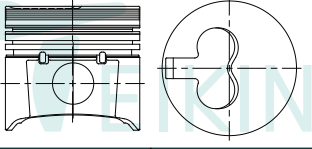
ADDENDUM TO TEIKIN CATALOG VOL.18 DATED SEPTEMBER 08, 2017

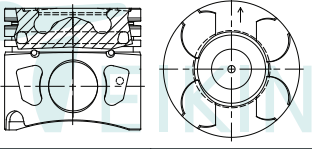
| ENGINE TYPE | PISTON | PISTON RING | PISTON PIN | PIN BUSHING | LINER | | LINER KIT SET |
|---|--|----------------------------------|--|-------------|---------|-----------|------------------------------------|
| | | | | | FLANGED | NO FLANGE | |
| SSANGYONG ACTYON 2.0L 5759 cc 4 cyl. | Ø 86.20 -17.0 CD 48.1 TL 78.1 | 1 - 2.5 FK 1 - 2.0 1 - 3.0 | Ø 30.000 TL 71.00  | | | | DIESEL APPLICATION TEIKIN NO. |
|  | TEIKIN NO. 69101AG | | TEIKIN NO. P 69101 | | | | 81 |
| Surface Treatment Moly Skirt | Bore Clearance MRC: 0.040 mm MP: 11.50 mm | | | | | | |
| | REFERENCE NO. 6640302817 | | | | | | |
| SUZUKI F5A 543 cc FRONTE 550 3 cyl. | Ø 62.00 -0.8 CD 27.4 TL 57.4 | 2 - 1.5 1 - 2.8 | Ø 16.000 TL 49.00  | | | | GASOLINE APPLICATION TEIKIN NO. |
|  | TEIKIN NO. 45114-3 | | TEIKIN NO. P 45114 | | | | 82 |
| Surface Treatment None | Bore Clearance MRC: 0.030 mm MP: 14.50 mm | | | | | | |
| | REFERENCE NO. 12111-78110 12111-78111 | | | | | | |
| SUZUKI ALTO 800 CC LXI 800 cc 3 cyl. | Ø 68.50 -1.1 CD 25.0 TL 41.0 | 1 - 1.0 1 - 1.2 1 - 2.0 | Ø 16.000 TL 48.00  | | | | GASOLINE APPLICATION TEIKIN NO. |
|  | TEIKIN NO. 45154 | | TEIKIN NO. P 45154 | | | | 83 |
| Surface Treatment None | Bore Clearance MRC: 0.030 mm MP: 6.50 mm | | | | | | |
| | REFERENCE NO. 12111-53M00-0A0 | | | | | | |
| SUZUKI G16KV-II 4 cyl. | Ø 75.00 -4.1 CD 28.3 TL 55.3 | 2 - 1.2 1 - 2.5 | Ø 19.000 TL 62.00  | | | | GASOLINE APPLICATION TEIKIN NO. |
|  | TEIKIN NO. 45153 | | TEIKIN NO. P 44259 | | | | 84 |
| Surface Treatment None | Bore Clearance MRC: 0.030 mm MP: 13.50 mm | | | | | | |
| | REFERENCE NO. 12100-61850-0A0 | | | | | | |

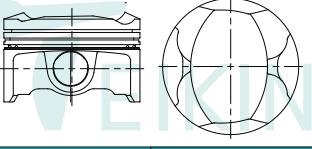
ADDENDUM TO TEIKIN CATALOG VOL.18 DATED SEPTEMBER 08, 2017

| ENGINE TYPE | PISTON | PISTON RING | PISTON PIN | PIN BUSHING | LINER | | LINER KIT SET |
|---|---|--------------------------------------|---|--------------------------|-------------------------|-----------|---------------|
| | | | | | FLANGED | NO FLANGE | |
| SUZUKI J20B 4 cyl. | \emptyset 84.00 -0.9 CD 30.6 TL 51.6 | 1 - 1.2 1 - 1.0 1 - 2.0 | \emptyset 21.000 TL 57.50  | | GASOLINE APPLICATION | | TEIKIN NO. |
|  | TEIKIN NO. 45152 | | TEIKIN NO. P 45152 | | | | 85 |
| Surface Treatment | Bore Clearance | | | | | | |
| Anodized Crown Moly Skirt 1st Ring Anodized | MRC: 0.030 mm MP: 8.00 mm | | | | | | |
| REFERENCE NO. 12100-54870-0A0 | | | | | | | |
| TATA INDICA-II 4 cyl. | \emptyset 75.00 -1.2 CD 43.0 TL 69.0 | 2 - 2.0 1 - 3.0 | \emptyset 23.010 TL 56.50  | | DIESEL APPLICATION | | TEIKIN NO. |
|  | TEIKIN NO. 62104A-4 | TEIKIN NO. R 62101 | TEIKIN NO. P 62101 | TEIKIN NO. B 62104A-4 | TEIKIN NO. LSF 62101 | | 86 |
| Surface Treatment | Bore Clearance | | | | | | |
| Chromated Moly Skirt | MRC: 0.030 mm MP: 11.50 mm | | | | | | |
| REFERENCE NO. | | REFERENCE NO. | | REFERENCE NO. | | | |
| | | 23041-04000 | | | | | |
| TATA 1.4 DICOR 4 cyl. | \emptyset 75.00 -13.9 CD 42.9 TL 66.9 | 1 - 2.5 FK 1 - 2.0 1 - 3.0 | \emptyset 27.000 TL 61.00  | | DIESEL APPLICATION | | TEIKIN NO. |
|  | TEIKIN NO. 62105AG | | TEIKIN NO. P 46629 | | | | 87 |
| Surface Treatment | Bore Clearance | | | | | | |
| Chromated | MRC: 0.030 mm MP: 7.50 mm | | | | | | |
| REFERENCE NO. | | | | | | | |
| TOYOTA 1NR-FE 1329 cc 4 cyl. | \emptyset 72.50 +3.7 CD 26.4 TL 47.8 | 2 - 1.0 1 - 1.5 | \emptyset 18.000 TL 53.00  | | GASOLINE APPLICATION | | TEIKIN NO. |
| AURIS ~ COROLLA HYBRID ~ IQ URBAN CRUISER VERSO ~ YARIS NSP90/110/120/130  | TEIKIN NO. 46702 | | TEIKIN NO. P 46332 | | | | 88 |
| Surface Treatment | Bore Clearance | | | | | | |
| Anodized Crown Moly Skirt 1st Ring Anodized | MRC: 0.030 mm MP: 6.00 mm | | | | | | |
| REFERENCE NO. 13101-47020 | | | | | | | |

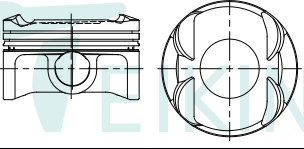
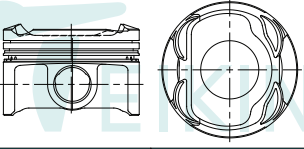
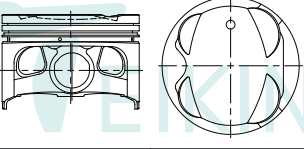
ADDENDUM TO TEIKIN CATALOG VOL.18 DATED SEPTEMBER 08, 2017

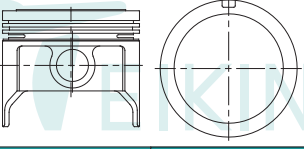
| ENGINE TYPE | PISTON | PISTON RING | PISTON PIN | PIN BUSHING | LINER | | LINER KIT SET |
|---|--|-------------------------------|--|---|---------|-----------|------------------------------------|
| | | | | | FLANGED | NO FLANGE | |
| TOYOTA 1NR-VE NEW AVANZA 1300CC 2015 / 2016 4 cyl. | \emptyset 72.50 +2.6 CD 26.1 TL 45.2 | 1 - 1.2 1 - 1.0 1 - 2.0 | \emptyset 18.000 TL 54.00 | | | | GASOLINE APPLICATION TEIKIN NO. |
|  | TEIKIN NO. 46390 | | TEIKIN NO. P 58107 | | | | |
| Surface Treatment Anodized Crown Moly Skirt 1st Ring Anodized | Bore Clearance MRC: 0.030 mm MP: 5.10 mm | | REFERENCE NO. 13211-0Y010 | | | | 89 |
| TOYOTA 2NR-VE NEW AVANZA 1500CC 2015 / 2016 4 cyl. | \emptyset 72.50 +2.6 CD 29.4 TL 48.5 | 1 - 1.2 1 - 1.0 1 - 2.0 | \emptyset 18.000 TL 54.00 | | | | GASOLINE APPLICATION TEIKIN NO. |
|  | TEIKIN NO. 46391 | | TEIKIN NO. P 58107 | | | | |
| Surface Treatment Anodized Crown Moly Skirt 1st Ring Anodized | Bore Clearance MRC: 0.030 mm MP: 5.50 mm | | REFERENCE NO. 13211-0Y060 | | | | 90 |
| TOYOTA 3S-FE-VI RAV 4 SXA1# ~ SXM10 (96-01) DOHC 16V 1998 cc 4 cyl. | \emptyset 86.00 -3.0 CD 35.0 TL 59.2 | 2 - 1.2 1 - 3.0 | \emptyset 22.000 TL 56.00 | | | | GASOLINE APPLICATION TEIKIN NO. |
|  | TEIKIN NO. 46701 | | TEIKIN NO. P 34101 | | | | |
| Surface Treatment Tin Coated | Bore Clearance MRC: 0.030 mm MP: 10.50 mm | | REFERENCE NO. 13101-14180 13101-74180 13103-74180 | | | | 91 |
| TOYOTA 3F NEW, 3FE 4 cyl. | \emptyset 94.00 +0.3 CD 37.4 TL 79.7 | 2 - 2.0 1 - 4.0 | \emptyset 22.000 TL 75.00 |  | | | GASOLINE APPLICATION TEIKIN NO. |
|  | TEIKIN NO. 46272-4 | | TEIKIN NO. P 46189 | | | | |
| Surface Treatment None | Bore Clearance MRC: 0.030 mm MP: 27.50 mm | | REFERENCE NO. 13101-61032 | | | | 92 |

ADDENDUM TO TEIKIN CATALOG VOL.18 DATED SEPTEMBER 08, 2017

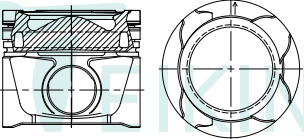

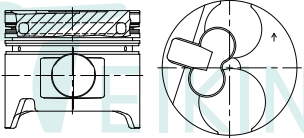

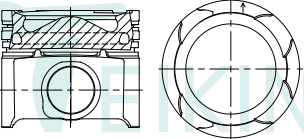

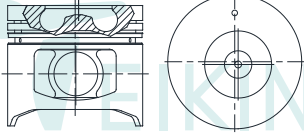
| ENGINE TYPE | PISTON | PISTON RING | PISTON PIN | PIN BUSHING | LINER | | LINER KIT SET |
|---|------------------------------|---------------|---------------|---|--------------------|---------------|---------------|
| | | | | | FLANGED | NO FLANGE | |
| TOYOTA | | | | | DIESEL APPLICATION | | |
| 2GD FTV | 2393 cc | Ø 92.00 | 1 - 2.0 HK | Ø 31.000 | | | TEIKIN NO. |
| NEW INNOVA DIESEL 2016 | 4 cyl. | -13.5 | 1 - 1.5 | TL 68.00 | | | |
| | CD 53.2 | | 1 - 3.0 |  | | | |
| | TL 78.2 | | | | | | |
|  | TEIKIN NO. | TEIKIN NO. | TEIKIN NO. | TEIKIN NO. | TEIKIN NO. | TEIKIN NO. | |
| | 46392AG | | P 46680 | | | | |
| | REFERENCE NO. | REFERENCE NO. | REFERENCE NO. | REFERENCE NO. | REFERENCE NO. | REFERENCE NO. | |
| | 13101-0E010-01 | | | | | | |
| | 13101-0E010-02 | | | | | | |
| Surface Treatment | Bore Clearance | | | | | | |
| Moly Skirt | MRC: 0.030 mm MP: 5.00 mm | | | | | | |
| | | | | | | | 93 |

| ENGINE TYPE | PISTON | PISTON RING | PISTON PIN | PIN BUSHING | LINER | | LINER KIT SET |
|--|-------------------------------|----------------------|---------------|---|--------------------|---------------|---------------|
| | | | | | FLANGED | NO FLANGE | |
| TOYOTA | | | | | DIESEL APPLICATION | | |
| 2LT NEW | 2466 cc | Ø 92.00 | 1 - 2.0 HK | Ø 29.000 | | | TEIKIN NO. |
| NEW INNOVA DIESEL 2016 | 4 cyl. | -2.5 | 1 - 2.0 | TL 74.00 | TL 160.5 | | LKFF 46389AG |
| | CD 44.3 | | 1 - 4.0 |  | OD 96.0 | | LKSF 46389AG |
| | TL 80.3 | | | | FT 3.5 | | LKXS 46389AG |
| | | | | | FD 100.7 | | |
|  | TEIKIN NO. | TEIKIN NO. | TEIKIN NO. | TEIKIN NO. | TEIKIN NO. | TEIKIN NO. | |
| | 46389AG | R 46240 | P 46256 | P 46256 | LFF 46260 | | |
| | REFERENCE NO. | REFERENCE NO. | REFERENCE NO. | REFERENCE NO. | REFERENCE NO. | REFERENCE NO. | |
| | 13101-54140-01 | 13011-54040/60/61/62 | | 90999-73115 | 11461-54030 | | |
| | 13101-54141 | 13011-54090/100 | | | 11461-54060 | | |
| | | 13013-54060/1/2/100 | | | | | |
| Surface Treatment | Bore Clearance | | | | | | |
| Tin Coated | MRC: 0.050 mm MP: 16.00 mm | | | | | | |
| | | | | | | | 94 |

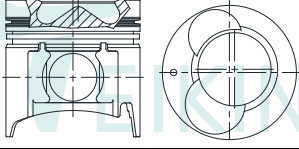

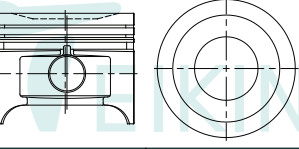

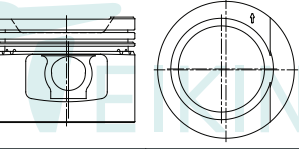

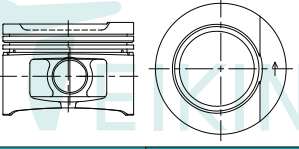
| ENGINE TYPE | PISTON | PISTON RING | PISTON PIN | PIN BUSHING | LINER | | LINER KIT SET |
|---|------------------------------|---------------|---------------|---|--------------------|---------------|---------------|
| | | | | | FLANGED | NO FLANGE | |
| TOYOTA | | | | | DIESEL APPLICATION | | |
| 1GD FTV | 2755 cc | Ø 92.00 | 1 - 2.0 HK | Ø 31.000 | | | TEIKIN NO. |
| NEW FORTUNER DIESEL 2016 | 4 cyl. | -14.4 | 1 - 1.5 | TL 68.00 | | | |
| | CD 53.2 | | 1 - 3.0 |  | | | |
| | TL 78.2 | | | | | | |
|  | TEIKIN NO. | TEIKIN NO. | TEIKIN NO. | TEIKIN NO. | TEIKIN NO. | TEIKIN NO. | |
| | 46393AG | | P 46680 | | | | |
| | REFERENCE NO. | REFERENCE NO. | REFERENCE NO. | REFERENCE NO. | REFERENCE NO. | REFERENCE NO. | |
| | 13101-0E020-02 | | | | | | |
| Surface Treatment | Bore Clearance | | | | | | |
| Chromated Moly Skirt | MRC: 0.030 mm MP: 7.50 mm | | | | | | |
| | | | | | | | 95 |

| ENGINE TYPE | PISTON | PISTON RING | PISTON PIN | PIN BUSHING | LINER | | LINER KIT SET |
|---|-------------------------------|---------------|---------------|---|--------------------|---------------|---------------|
| | | | | | FLANGED | NO FLANGE | |
| TOYOTA | | | | | DIESEL APPLICATION | | |
| 14Z | 5204 cc | Ø 98.00 | 2 - 2.0 | Ø 32.000 | | | TEIKIN NO. |
| (5FD50/60/70 ~ 7FD35/40/45) 2003- | 6 cyl. | -19.0 | 1 - 4.0 | TL 77.00 | TL 181.5 | | LKFF 46699 |
| | CD 50.0 | | |  | OD 101.0 | | LKSF 46699 |
| | TL 88.0 | | | | FT 5.0 | | |
| | | | | | FD 107.0 | | |
|  | TEIKIN NO. | TEIKIN NO. | TEIKIN NO. | TEIKIN NO. | TEIKIN NO. | TEIKIN NO. | |
| | 46699 | R 46685 | P 46682 | B 46685 | LFF 46685 | | |
| | REFERENCE NO. | REFERENCE NO. | REFERENCE NO. | REFERENCE NO. | REFERENCE NO. | REFERENCE NO. | |
| | 13101-78781-71 | 13011-78700 | | 90384-32950 | 11461-78700 | | |
| | 13103-78781-71 | 13011-78701 | | 90384-32951 | | | |
| | 13105-78781-71 | 13011-78760 | | | | | |
| Surface Treatment | Bore Clearance | | | | | | |
| Tin Coated Anodized Crown | MRC: 0.070 mm MP: 17.00 mm | | | | | | |
| | | | | | | | 96 |

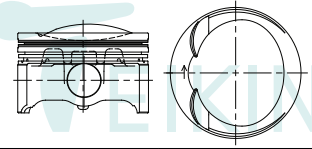

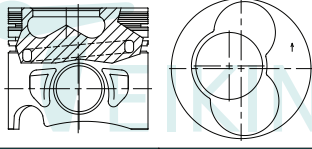

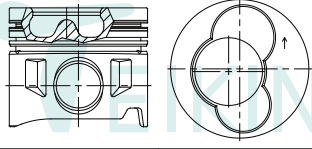

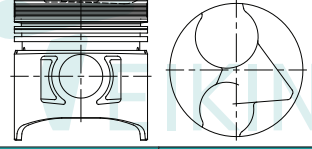
ADDENDUM TO TEIKIN CATALOG VOL.18 DATED SEPTEMBER 08, 2017

| ENGINE TYPE | PISTON | PISTON RING | PISTON PIN | PIN BUSHING | LINER | | LINER KIT SET |
|---|-------------------------------|---|---|---|---|--|---------------|
| | | | | | FLANGED | NO FLANGE | |
| TOYOTA | | | | | DIESEL APPLICATION | | |
| N04C | 4009 cc | Ø 104.00 | 1 - 3.0 FK | Ø 37.000 | | | TEIKIN NO. |
| COASTER ~ DYNA XZB40/50# 2006- | 4 cyl. | -19.0 | 1 - 2.0 | TL 85.00 | | | LKFF 46700A |
| | | CD 60.1 TL 106.1 | 1 - 4.0 |  | | TL 200.0 OD 107.0 FT 8.0 FD 112.0 | |
|  | | | | | | | |
| Surface Treatment | Bore Clearance | | | | | | |
| Tin Coated | MRC: 0.080 mm MP: 22.00 mm | | | | | | |
| | | TEIKIN NO. | TEIKIN NO. | TEIKIN NO. | TEIKIN NO. | TEIKIN NO. | |
| | | 46700A | R 46700 | P 36659 | B 46339 | LFF 46700 | |
| | | REFERENCE NO. | REFERENCE NO. | REFERENCE NO. | REFERENCE NO. | | |
| | | 13211-78170 13211-78190 13216-E0020 | 13011-78190 13011-78230 13011-78220 | 13271-89102 | 11461-78021 11461-78031 11461-78051 | | |
| | | | | | | | 97 |
| VOLGA | | | | | GASOLINE APPLICATION | | |
| GAZ 421 | 1980 | Ø 100.00 | 2 - 2.0 | Ø 25.000 | | | TEIKIN NO. |
| | 4 cyl. | -4.0 | 1 - 5.0 | TL 67.00 | | | |
| | | CD 43.7 TL 80.0 | |  | | | |
|  | | | | | | | |
| Surface Treatment | Bore Clearance | | | | | | |
| None | MRC: 0.030 mm MP: 16.50 mm | | | | | | |
| | | TEIKIN NO. | | TEIKIN NO. | | | |
| | | 60104 | | P 39157 | | | |
| | | REFERENCE NO. | | | | | |
| | | 421.1004014 | | | | | |
| | | | | | | | 98 |
| VOLKSWAGEN | | | | | GASOLINE APPLICATION | | |
| 1.8L | 1800 cc | Ø 81.00 | 1 - 1.5 | Ø 20.000 | | | TEIKIN NO. |
| SOHC 8 VAL DERBY GOLF A2 JETTA A2 , CORSAR 89 | 4 cyl. | -8.0 | 1 - 1.75 | TL 56.58 | | | |
| | | CD 32.2 TL 62.4 | 1 - 3.0 |  | | | |
|  | | | | | | | |
| Surface Treatment | Bore Clearance | | | | | | |
| Tin Coated | MRC: 0.030 mm MP: 9.50 mm | | | | | | |
| | | TEIKIN NO. | | TEIKIN NO. | | | |
| | | 48216 | | P 42165 | | | |
| | | REFERENCE NO. | | | | | |
| | | 026107103Q | | | | | |
| | | | | | | | 99 |
| VOLKSWAGEN | | | | | GASOLINE APPLICATION | | |
| 1.8L-II | 4 cyl. | Ø 81.00 | 1 - 1.2 | Ø 20.000 | | | TEIKIN NO. |
| | | +1.0 | 1 - 1.5 | TL 56.58 | | | |
| | | CD 32.3 TL 57.3 | 1 - 2.0 |  | | | |
|  | | | | | | | |
| Surface Treatment | Bore Clearance | | | | | | |
| Tin Coated | MRC: 0.030 mm MP: 6.50 mm | | | | | | |
| | | TEIKIN NO. | | TEIKIN NO. | | | |
| | | 48219 | | P 42165 | | | |
| | | REFERENCE NO. | | | | | |
| | | 27107103 | | | | | |
| | | | | | | | 100 |

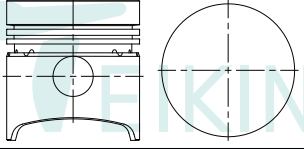

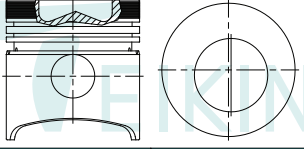

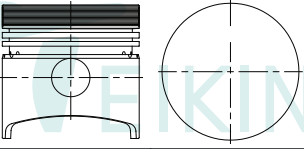

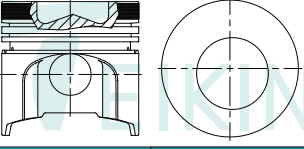
ADDENDUM TO TEIKIN CATALOG VOL.18 DATED SEPTEMBER 08, 2017

| ENGINE TYPE | PISTON | PISTON RING | PISTON PIN | PIN BUSHING | LINER | | LINER KIT SET |
|---|---|---|---|-----------------------|---|-----------|---------------|
| | | | | | FLANGED | NO FLANGE | |
| VOLKSWAGEN BZB TFSI 16V FSI 16V 4 cyl. | Ø 82.51 +5.6 CD 29.8 TL 55.9 | 1 - 1.2 1 - 1.5 1 - 2.0 | Ø 21.000 TL 54.00  | | GASOLINE APPLICATION | | TEIKIN NO. |
|  | TEIKIN NO. 48218A | | TEIKIN NO. P 33101 | | | | 101 |
| Surface Treatment: Moly Skirt Bore Clearance: MRC: 0.030 mm, MP: 9.00 mm | REFERENCE NO. 06H 107 065BK | | | | | | |
| VOLKSWAGEN ANU/ATD/AVB/AVQ 1896 cc 4 cyl. | Ø 79.50 -17.1 CD 45.8 TL 68.8 | 1 - 1.75 1 - 2.0 1 - 3.0 | Ø 26.000 TL 66.00  | | DIESEL APPLICATION | | TEIKIN NO. |
|  | TEIKIN NO. 48612AG | TEIKIN NO. R 48612 | TEIKIN NO. P G1113 | TEIKIN NO. B 43614 | TEIKIN NO. LSF 48612 | | 102 |
| Surface Treatment: Moly Skirt Bore Clearance: MRC: 0.040 mm, MP: 6.50 mm | REFERENCE NO. | REFERENCE NO. KS: 800000810000 KS: 800051640000 MAHLE: 03020N0 G-0811490000 | REFERENCE NO. | REFERENCE NO. | REFERENCE NO. KS: 89 434 190 MAHLE: 029 WV 20 A-SU351317 G-1402795000 | | |
| VOLKSWAGEN ACV/AGX/AHD/AHY 2461 cc 5 cyl. | Ø 81.00 -17.2 CD 45.8 TL 69.8 | 1 - 2.5 1 - 2.0 1 - 3.0 | Ø 26.000 TL 68.00  | | DIESEL APPLICATION | | TEIKIN NO. |
|  | TEIKIN NO. 48613A | TEIKIN NO. R 48613 | TEIKIN NO. P 44603 | TEIKIN NO. B 48613 | TEIKIN NO. LSF 48613 | | 103 |
| Surface Treatment: Anodized Crown, Moly Skirt Bore Clearance: MRC: 0.040 mm, MP: 6.00 mm | REFERENCE NO. | REFERENCE NO. KS: 800001150000 KS: 800073910000 MAHLE: 030 48 N0 MAHLE: 034 90 N0 | REFERENCE NO. | REFERENCE NO. | REFERENCE NO. MAHLE: 029 WV 25 N-1402042000 | | |
| KUBOTA 1512 TCVS 4 cyl. | Ø 76.00 -2.2 CD 43.7 TL 80.2 | 1 - 2.5 HK 1 - 2.0 1 - 5.0 | Ø 25.000 TL 64.00  | | STATIONERY & AGRICULTURE APPLICATION | | TEIKIN NO. |
|  | TEIKIN NO. G0130A | | TEIKIN NO. P 42601 | | | | 104 |
| Surface Treatment: Tin Coated Bore Clearance: MRC: 0.080 mm, MP: 16.50 mm | REFERENCE NO. | | | | | | |

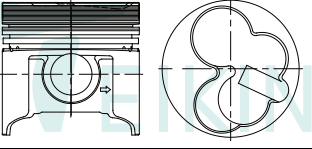

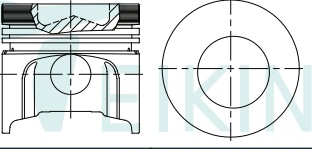

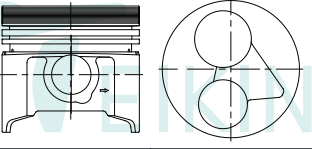

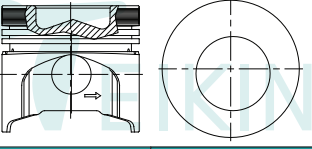

ADDENDUM TO TEIKIN CATALOG VOL.18 DATED SEPTEMBER 08, 2017

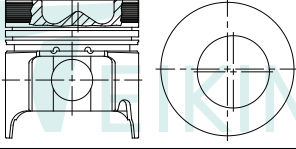
| ENGINE TYPE | PISTON | PISTON RING | PISTON PIN | PIN BUSHING | LINER | | LINER KIT SET |
|---|--|----------------------------------|--|-------------|--------------------------------------|-----------|---------------|
| | | | | | FLANGED | NO FLANGE | |
| KUBOTA V1502 4 cyl. | Ø 76.00 CD 43.5 TL 80.1 | 1 - 2.5 HK 1 - 2.0 1 - 5.0 | Ø 23.000 TL 63.00  | | STATIONERY & AGRICULTURE APPLICATION | | TEIKIN NO. |
|  | TEIKIN NO. G0131 | | TEIKIN NO. P 51132 | | | | 105 |
| Surface Treatment Tin Coated | Bore Clearance MRC: 0.070 mm MP: 19.00 mm | | | | | | |
| REFERENCE NO. 15221-21110 | | | | | | | |
| KUBOTA V1512DI 4 cyl. | Ø 76.00 CD 43.6 TL 80.0 | 1 - 2.5 HK 1 - 2.0 1 - 5.0 | Ø 25.000 TL 64.00  | | STATIONERY & AGRICULTURE APPLICATION | | TEIKIN NO. |
|  | TEIKIN NO. G0127 | | TEIKIN NO. P 42601 | | | | 106 |
| Surface Treatment Tin Coated | Bore Clearance MRC: 0.070 mm MP: 18.00 mm | | | | | | |
| REFERENCE NO. | | | | | | | |
| KUBOTA V1702 4 cyl. | Ø 82.00 CD 43.5 TL 80.0 | 1 - 2.5 HK 1 - 2.0 1 - 5.0 | Ø 23.000 TL 63.00  | | STATIONERY & AGRICULTURE APPLICATION | | TEIKIN NO. |
|  | TEIKIN NO. G0129 | | TEIKIN NO. P 51132 | | | | 107 |
| Surface Treatment Tin Coated | Bore Clearance MRC: 0.080 mm MP: 19.50 mm | | | | | | |
| REFERENCE NO. 15201-21110 | | | | | | | |
| KUBOTA V1702DI 4 cyl. | Ø 82.00 CD 43.6 TL 80.1 | 1 - 2.5 HK 1 - 2.0 1 - 5.0 | Ø 25.000 TL 64.00  | | STATIONERY & AGRICULTURE APPLICATION | | TEIKIN NO. |
|  | TEIKIN NO. G0126 | | TEIKIN NO. P 42601 | | | | 108 |
| Surface Treatment Tin Coated | Bore Clearance MRC: 0.070 mm MP: 18.50 mm | | | | | | |
| REFERENCE NO. 17302-21120 | | | | | | | |

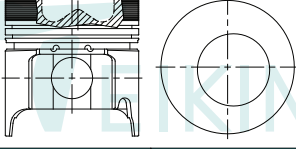

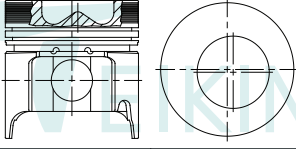

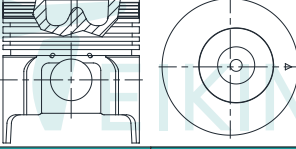

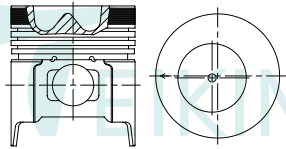

ADDENDUM TO TEIKIN CATALOG VOL.18 DATED SEPTEMBER 08, 2017

| ENGINE TYPE | PISTON | PISTON RING | PISTON PIN | PIN BUSHING | LINER | | LINER KIT SET |
|--|---|----------------------------------|--|-------------|--------------------------------------|-----------|---------------|
| | | | | | FLANGED | NO FLANGE | |
| KUBOTA 83MM 1 cyl. | Ø 83.00 -3.9 CD 43.5 TL 80.3 | 1 - 2.0 HK 1 - 2.0 1 - 3.0 | Ø 25.000 TL 64.00  | | STATIONERY & AGRICULTURE APPLICATION | | TEIKIN NO. |
|  | | TEIKIN NO. | TEIKIN NO. | | | | 109 |
| Surface Treatment Tin Coated Bore Clearance MRC: 0.030 mm MP: 16.50 mm | | G0133A | P 39624 | | | | |
| | | REFERENCE NO. | | | | | |
| KUBOTA 1902DI 4 cyl. | Ø 85.00 -13.4 CD 43.6 TL 80.1 | 1 - 2.5 HK 1 - 2.0 1 - 5.0 | Ø 25.000 TL 64.00  | | STATIONERY & AGRICULTURE APPLICATION | | TEIKIN NO. |
|  | | TEIKIN NO. | TEIKIN NO. | | | | 110 |
| Surface Treatment Tin Coated Bore Clearance MRC: 0.070 mm MP: 17.00 mm | | G0132 | P 42601 | | | | |
| | | REFERENCE NO. | | | | | |
| | | 17365-21120 | | | | | |
| KUBOTA V2203 4 cyl. | Ø 87.00 -1.5 CD 43.5 TL 80.0 | 1 - 2.5 HK 1 - 2.0 1 - 5.0 | Ø 25.000 TL 64.00  | | STATIONERY & AGRICULTURE APPLICATION | | TEIKIN NO. |
|  | | TEIKIN NO. | TEIKIN NO. | | | | 111 |
| Surface Treatment Tin Coated Bore Clearance MRC: 0.030 mm MP: 17.00 mm | | G0128 | P 42601 | | | | |
| | | REFERENCE NO. | | | | | |
| | | 19077-21112 | | | | | |
| KUBOTA V2203DI 4 cyl. | Ø 87.00 -14.8 CD 43.5 TL 80.0 | 1 - 2.5 HK 1 - 2.0 1 - 5.0 | Ø 25.000 TL 64.00  | | STATIONERY & AGRICULTURE APPLICATION | | TEIKIN NO. |
|  | | TEIKIN NO. | TEIKIN NO. | | | | 112 |
| Surface Treatment Tin Coated Bore Clearance MRC: 0.060 mm MP: 17.50 mm | | G0125 | P 42601 | | | | |
| | | REFERENCE NO. | | | | | |
| | | 16641-21110 | | | | | |

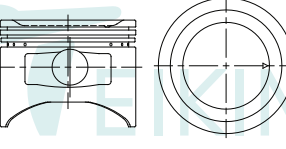
ADDENDUM TO TEIKIN CATALOG VOL.18 DATED SEPTEMBER 08, 2017

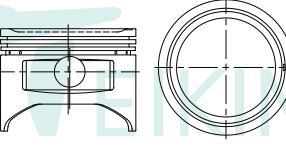
| ENGINE TYPE | PISTON | PISTON RING | PISTON PIN | PIN BUSHING | LINER | | LINER KIT SET |
|--|---|--------------------------------------|---|-------------|---|-----------|-------------------|
| | | | | | FLANGED | NO FLANGE | |
| YANMAR 4D84 1 cyl.  | \varnothing 84.00 -15.0 CD 50.3 TL 86.8 | 2 - 2.0 1 - 4.0 | \varnothing 26.000 TL 66.00  | | STATIONERY & AGRICULTURE APPLICATION | | TEIKIN NO. |
| Surface Treatment None | Bore Clearance MRC: 0.060 mm MP: 20.00 mm | TEIKIN NO. G1121-1 | TEIKIN NO. P G1113 | | | | 113 |
| | REFERENCE NO. | | | | | | |
| YANMAR 3D84-II 4 cyl.  | \varnothing 84.00 CD 42.0 TL 84.0 | 2 - 2.0 1 - 4.0 | \varnothing 26.000 TL 66.00  | | STATIONERY & AGRICULTURE APPLICATION | | TEIKIN NO. |
| Surface Treatment Tin Coated | Bore Clearance MRC: 0.130 mm MP: 20.00 mm | TEIKIN NO. G1123 | TEIKIN NO. P G1113 | | | | 114 |
| | REFERENCE NO. 129367-22020 | | | | | | |
| YANMAR 4D84 4 cyl.  | \varnothing 84.00 -15.0 CD 50.3 TL 86.8 | 2 - 2.0 1 - 4.0 | \varnothing 26.000 TL 66.00  | | STATIONERY & AGRICULTURE APPLICATION | | TEIKIN NO. |
| Surface Treatment None | Bore Clearance MRC: 0.060 mm MP: 20.00 mm | TEIKIN NO. G1121 | TEIKIN NO. P G1113 | | | | 115 |
| | REFERENCE NO. | | | | | | |
| YANMAR TF120 638 cc 1 cyl.  | \varnothing 92.00 -17.8 CD 54.3 TL 96.8 | 3 - 2.5 1 - 4.0 | \varnothing 28.000 TL 71.00  | | STATIONERY & AGRICULTURE APPLICATION | | TEIKIN NO. |
| Surface Treatment None | Bore Clearance MRC: 0.160 mm MP: 25.00 mm | TEIKIN NO. G1606 G1606A | TEIKIN NO. P 44684 | | | | 116 |
| | REFERENCE NO. | | | | | | |

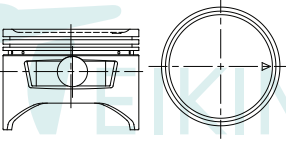
ADDENDUM TO TEIKIN CATALOG VOL.18 DATED SEPTEMBER 08, 2017

| ENGINE TYPE | PISTON | PISTON RING | PISTON PIN | PIN BUSHING | LINER | | LINER KIT SET |
|--|--|------------------------|---|-------------|---|-----------|---------------|
| | | | | | FLANGED | NO FLANGE | |
| YANMAR TF 140 1 cyl.  | \varnothing 96.00 -19.5 CD 61.2 TL 108.2 | 3 - 2.5 1 - 4.5 | \varnothing 32.000 TL 80.00  | | STATIONERY & AGRICULTURE APPLICATION | | TEIKIN NO. |
| Surface Treatment None | Bore Clearance MRC: 0.120 mm MP: 25.00 mm | TEIKIN NO. G1122 | TEIKIN NO. P G1106 | | | | 117 |
| | REFERENCE NO. 105700-22090 | | | | | | |
| OTHER GX 160 1 cyl.  | \varnothing 68.00 -2.8 CD 23.6 TL 53.5 | 2 - 1.5 1 - 2.5 | \varnothing 18.000 TL 54.00  | | NON-AUTOMOTIVE APPLICATION | | TEIKIN NO. |
| Surface Treatment None | Bore Clearance MRC: 0.030 mm MP: 16.00 mm | TEIKIN NO. G4103 | TEIKIN NO. P 58107 | | | | 118 |
| | REFERENCE NO. 13101-ZF1-010 | | | | | | |
| OTHER GX 390 1 cyl.  | \varnothing 88.00 -2.1 CD 28.0 TL 66.5 | 2 - 2.0 1 - 2.8 | \varnothing 20.000 TL 62.00  | | NON-AUTOMOTIVE APPLICATION | | TEIKIN NO. |
| Surface Treatment None | Bore Clearance MRC: 0.030 mm MP: 21.00 mm | TEIKIN NO. G4102 | TEIKIN NO. P 38129 | | | | 119 |
| | REFERENCE NO. 13101-ZF6-W00 | | | | | | |
| OTHER GX 420 1 cyl.  | \varnothing 90.00 -2.1 CD 28.0 TL 66.5 | 2 - 2.0 1 - 2.8 | \varnothing 20.000 TL 61.00  | | NON-AUTOMOTIVE APPLICATION | | TEIKIN NO. |
| Surface Treatment None | Bore Clearance MRC: 0.030 mm MP: 22.50 mm | TEIKIN NO. G4104 | TEIKIN NO. P 46310 | | | | 120 |
| | REFERENCE NO. | | | | | | |